

**Nove of Margate
7870 Margate Blvd.
Subdivision Resurvey Narrative**

Fimiani Development Corporation (“Applicant”), with authorization from Margate Executive Golf Course, LLC, owner of the property formerly known as “Margate Executive Golf Course,” hereby submits this request for approval of a subdivision resurvey application. The Property in question was previously platted. Applicant proposes modifying the subdivision lines to create individual townhome lots to facilitate the development of a 132 townhome project on the Property. This request is being submitted in association with a land use plan amendment, rezoning, and site plan application for a new townhouse residential development on the Property.

For further information, please review survey, prior approved plat, and proposed subdivision resurvey plan.

Concurrency Compliance

Per Section 31-49 of the City Code, Petitioner must demonstrate compliance with concurrency standards for any site plan application. The concurrency standards are stated below in Bold text, with the responses provided in Italics.

- 1. Project description: Applicant, location, land use and zoning, density or intensity, project phasing and other pertinent information as determined by the applicant needed to properly review the application.**

Name, address and telephone number of the applicant

*Fimiani Development Corporation
5301 N. Federal Highway, Suite 350
Boca Raton, FL 33486
Contact: Michael Fimiani
Telephone: 561-395-8882*

Location

The Property is an abandoned golf course located on the south side of Margate Boulevard west of NW 76th Avenue and consists of +/- 21.96 gross acres.

Land Use & Zoning

The City Land Use Plan designation for Parcel 1 is Commercial Recreation within an Irregular 7.6 Residential Dashed Line Area and the Broward County Land Use Plan designation is Recreation and Open Space within an Irregular 7.6 Residential Dashed Line Area. The current zoning for Parcel 1 is S-1 (Recreational). The proposed land use designation for Parcel 1 is split, with 1.11 gross acres being designated as Parks on the City’s Future Land Use Map and Recreation

& Open Space on the County's Future Land Use Map, with 20.24 gross acres designated as Residential 7 within an Irregular 8.38 Dashed Line Area on the City and County Future Land Use Maps. The proposed zoning designation of Parcel 1 is PUD.

The City Land Use Plan designation for Parcel 2 is Residential (7) within an Irregular 7.6 Residential Dashed Line Area and the Broward County Land Use Plan Designation is Irregular 7.6 Residential within a Dashed Line Area. The current zoning for Parcel 2 is R-3A (Multiple-Dwelling Residential District). The future land use designation for this parcel is being amended to Parks on the City's Future Land Use Map and Recreation & Open Space on the County's Future Land Use map, while the zoning designation will be amended from R-3A to PUD.

Density

The City Land Use Plan designation for the Parcel 1 is Commercial Recreation within an Irregular 7.6 Residential dashed line area and the City Land Use Plan designation for Parcel 2 is Residential (7) within an Irregular 7.6 Residential Dashed Line Area. The gross acreage of the Irregular 7.6 Residential dashed line area is 104.3 acres. Based on the maximum allowable density of 7.6 dwelling unit/acres, 792 dwelling units are permitted to be developed in the dashed line area. City staff confirmed that there are 742 dwelling units constructed in the dashed line area, leaving 50 remaining units that could be constructed on the Property. The Petitioner is proposing to develop 132 residential units ("Project") on the Property. This requires an amendment to the land use plan designation on the Property to add an additional 82 dwelling units to the overall dashed line area.

Project Phasing

There is no phasing proposed with this development. All of the units will be developed in one stage.

- 2. Transportation system: An analysis performed by Broward County or prepared in accordance with the Broward County TRIPS model, as amended from time to time.**

A traffic study has been included with this submittal that demonstrates that the proposed development is projected to generate approximately 921 daily trips, approximately 64 AM peak hour trips and approximately 77 trips during the typical afternoon peak period. Furthermore, The project driveway is projected to operate at level of service "A" as proposed. Please refer to the traffic impact study for more details.

- 3. Drainage, solid waste, water and wastewater: Documentation from the appropriate service provider regarding provision of services.**

Drainage

- 1. Provide the drainage level of service per the adopted and certified local land use plan.**

The adopted level of service standards for drainage facilities as contained in Policy 3.2.1 of the City's Comprehensive Plan are provided below.

Road protection. Residential streets not greater than fifty feet to have crown elevations no lower than the elevation for the respective area depicted on the ten year "Flood Criteria Map." Rights-of-way greater than fifty feet to have an ultimate edge of pavement no lower than the elevation for the respective area depicted on the ten-year "Flood Criteria Map."

Buildings. To have the lowest floor elevation no lower than the elevation for the respective area

depicted on the “100-Year Flood Elevation Map.”

Off-site discharge. Not to exceed the inflow limit of SFWMD primary receiving canal or the local conveyance system, whichever is less.

Storm sewers. Design frequency minimum to be three-year rainfall intensity off the State DOT Zone 10 Rainfall curves.

Floodplain routing. Calculated flood elevations based on the ten year and one-hundred-year return frequency rainfall of three-day duration shall not exceed the corresponding elevations of the ten year “Flood Criteria Map” and the “100 Year Flood Elevation Map.”

Antecedent water level. The higher elevation of either the control elevation or the elevation depicted on the map “Average Wet Season Water Levels.”

On-site storage. Minimum capacity above antecedent water level and below floodplain routing elevations to be design rainfall volumes minus off-site discharge occurring during design rainfall.

Best management practices (BMP). Prior to discharge to surface or ground water, BMPs will be used to reduce pollutant discharge.

The drainage system that is ultimately built on the Subject Property will also meet the Broward County and South Florida Water Management District drainage requirements.

2. Identify the drainage district and drainage systems serving the amendment area.

The Subject Property is within the C-14 basin. The requirements of the City of Margate, South Florida Water Management District (“SFWMD”) and the Broward County Development Management and Environmental Review Section will be applied to the ultimate drainage system for the Subject Property.

A Margate canal flows thru the site. The existing flowage easement will be relocated and maintained as part of the proposed design. Parts of the existing canal are located on the property line and service the adjacent properties. The storm water from the adjacent townhomes and condominium properties flow into the on-site canals. This historical flow will be maintained as part of the proposed design.

3. Identify any planned drainage improvements, including year, funding sources and other relevant information.

Currently, there are no planned drainage improvements set forth by the City.

4. Indicate if a Surface Water Management Plan has been approved by, or an application submitted to, the SFWMD and/or any independent drainage district, for the amendment site. Identify the permit number(s), or application number(s) if the project is pending, for the amendment site. If an amendment site is not required to obtain a SFWMD permit, provide documentation of same.

No formal application has been made to the local drainage districts; but, preliminary surface water management calculations and a plan were review by Broward County Environmental Engineering and Permitting Division. Attached is an email confirming they are in agreement with the concept presented (Exhibit A). The onsite drainage system will be designed to meet all

applicable levels of service standards.

- 5. If the area in which the amendment is located does not meet the adopted level of service and there are no improvements planned (by the unit of local government or drainage authority) to address the deficiencies, provide an engineering analysis which demonstrates how the site will be drained and the impact on the surrounding properties. The information should include the wet season water level for the amendment site, design storm elevation, natural and proposed land elevation, one hundred year flood elevation, acreage of proposed water management retention area, elevations for buildings, roads and yards, storage and runoff calculations for the design storm and estimated time for flood waters to recede to natural land elevation.**

The existing surface water management system for the Subject Property consists of series of water features constructed to provide drainage for the golf course and surrounding communities. The proposed design will consist of a combination of the existing canals and proposed lakes to provide on-site storage to meet the minimum flood designs. A crowned roadway with valley gutter curb on both sides of the street is proposed. The community will have positive drainage through inlets and pipes discharging into the lake and canal. An existing culvert under Margate Boulevard will be maintained and extended to connect to the proposed lake pending the final site plan design. Existing drainage from the adjacent residential communities will be maintained and allowed to continue to flow through the property. Proper easements will be provided.

Water quality treatment and water storage will be provided in the proposed lakes as required by the permitting agencies. The developed area storm water management system will provide for attenuation of runoff from storm events including protection of interior roadways, buildings, and the adjacent areas.

- 6. Correspondence from local drainage district verifying the information submitted as part of the application on items 1-5 above. Correspondence must contain name, position and contact information of party providing verification.**

A letter from the City of Margate Department of Environmental & Engineering Services has been provided as Exhibit G (Letter) in the LUPA application.

Solid Waste

- 1. Provide the solid waste level of service per the adopted and certified local land use plan.**
According to Policy 4.1.4 of City's Comprehensive Plan, the adopted level of service for solid waste for residential dwelling units is 8.9 pounds per dwelling unit per day.
- 2. Identify the solid waste facility serving the service area in which the amendment is located including the landfill/plant capacity, current and committed demand on the landfill/plant capacity and planned landfill/plant capacity.**
The Property is served by the Wheelabrator South Broward Waste to Energy Facility located at 4400 S. State Rd. 7, Fort Lauderdale, FL 33314. Per the Solid Waste Element of the Broward County Comprehensive Plan, the facility has a gross electrical generating capacity of approximately 66 megawatts. In anticipation of future disposal needs, Broward County has received certification for ultimate generating capacities of 96.1 megawatts.
- 3. Identify the net impact on solid waste demand, based on the adopted level of service, resulting from the proposed amendment. Provide calculations, including anticipated demand per square foot or dwelling unit.**

Existing Use		
Development Intensity	Generation Rate	Demand
Golf Course (Commercial Rate is Applied)	2 lbs./day	2 lbs./day
Proposed Use		
Development Intensity	Generation Rate*	Demand
132 dwelling units	8.9 lbs./unit/day	1,174 lbs./day
		NET CHANGE: +1,172 lbs./day

- 4. Correspondence from the solid waste provider verifying the information submitted as part of the application on items 1-3 above. Correspondence must contain name, position and contact information of party providing verification.**

An e-mail correspondence from Bob Hely with Wheelabrator Technologies confirming the landfill capacity and a letter from Republic Services confirming capacity to service the project have been provided with this submittal.

Water

- 1. Provide the potable water level of service per the adopted and certified local land use plan, including the adoption date of the 10 Year Water Supply Facilities Plan.**
The potable water level of service per the adopted comprehensive plan is 335 gallons per day (gpd). The City adopted the 10-Year Water Supply Facilities Work Plan in March 2015.
- 2. Identify the potable water facility serving the service area in which the amendment is located including the current plant capacity, current and committed demand on the plant and planned plant capacity expansions, including year and funding sources. Identify the wellfield serving the area in which the amendment is located including the South Florida Water Management District (SFWMD) permitted withdrawal, including the expiration date of the SFWMD permit.**

The City's potable water system consists of raw water supply, water treatment and distribution.

Plant Capacity:

The City's water treatment plant has a total permitted maximum day operating capacity of 13.5 mgd. The total permitted maximum day flow for 2018 is 6.766 MGD. The system includes two (2) above ground storage tanks with a combined capacity of 3.9 mgd and a remote storage facility with a capacity of 2 mgd. No plant improvements are proposed at this time.

Wells:

The City has 12 raw water wells on and around the property where the water treatment plant is located. The City draws its water from the Biscayne Aquifer. The City's Consumptive Use Permit ("CUP") was issued on April 13, 2005 for 20-year duration and will expire April 13, 2025. (Permit No. 06-00121-W). The CUP authorizes an annual allocation of 9.3 million gallons per day (mgd)

and stipulates a reduced annual allocation of 8.51 mgd, effective April 13, 2010.

Distribution System:

The City maintains a water distribution system consisting of approximately 225 miles of distribution mains and a remote 2-million gallon water storage tank. There is an existing 12” water main along Margate Boulevard that fronts the property.

3. **Identify the net impact on potable water demand, based on adopted level of service, resulting from the proposed amendment. Provide calculations, including anticipated demand per square foot or dwelling unit.**

Existing Use		
Development Intensity	Generation Rate	Demand
Golf Course	Golf Course 10 gpd / person x 150 people / day	.0015 MGD
Proposed Use:		
Development Intensity	Generation Rate*	Demand
132 dwelling units	335 gpd/ERC	0.0442 MGD
		Net Change: + 0.0427 MGD

4. **Correspondence from potable water provider verifying the information submitted as part of the application on items 1-3 above. Correspondence must contain name, position and contact information of party providing verification.**

A letter from the City of Margate Department of Environmental & Engineering Services has been provided as Exhibit D (Water & Wastewater Letter) in the LUPA application.

Sanitary Sewer Analysis

1. **Provide the sanitary sewer level of service per the adopted and certified local land use plan. The adopted level of service standard for sanitary sewer service as identified in Policy 2.2.2 of the adopted Comprehensive Plan is 335 gallons per day (gpd) per equivalent residential connection (ERC).**
2. **Identify the sanitary sewer facility serving the area in which the amendment is located including the current plant capacity, current and committed demand on the plant and planned plant capacity expansions, including year and funding sources.**

The Subject Property is within the service area of the City of Margate Wastewater Treatment Plant which consists of these major operating components:

- A wastewater treatment plant, which provides secondary treatment.

- *A deep well injection effluent disposal system.*
- *A series of gravity collection mains which serve specific geographical neighborhoods and which discharge into the wet wells of one or more sewage pumping stations strategically located in each area.*
- *An integrated system of pumping stations that pump raw sewage into force mains and interceptors leading to the wastewater treatment plant.*

There is an existing 12” gravity sewer main located in the Margate Boulevard right of way. This gravity sewer flows to lift station #24. A gravity sewer system will be constructed on the Subject Property that will flow to an onsite private lift station. A force main from the private lift station will connect to a gravity sewer manhole on Margate Boulevard.

The City’s Comprehensive Plan indicates that the City’s Wastewater Treatment Plant has adequate capacity for buildout of the City. The current statistics for the plant are provided below.

Design Capacity: 12.1 MGD

Permitted Operating Capacity 10.01 MGD

Current Demand: 6.519 MGD

- Identify the net impact on sanitary sewer demand, based on the adopted level of service, resulting from the proposed amendment. Provide calculations, including anticipated demand per square foot or dwelling unit.***

<i>Existing Use</i>		
<i>Development Intensity</i>	<i>Generation Rate</i>	<i>Demand</i>
<i>Golf Course</i>	<i>Golf Course 10 gpd / person x 150 people / day</i>	<i>.0015 MGD</i>
<i>Proposed Use:</i>		
<i>Development Intensity</i>	<i>Generation Rate*</i>	<i>Demand</i>

<i>132 dwelling units</i>	<i>335 gpd/ERC</i>	<i>0.0442 MGD</i>
	<i>Net Change: + 0.0427 MGD</i>	

- 4. Correspondence from sanitary sewer provider verifying the information submitted as part of the application on items 1-4 above. Correspondence must contain name, position and contact information of party providing verification.***

A letter from the City of Margate Department of Environmental & Engineering Services has been provided as Exhibit D (Water & Wastewater Letter) in the LUPA application.



Nove of Margate

Margate, Florida

prepared for:

Fimiani Development Corporation

traffic study

TRAFTECH
ENGINEERING, INC.

Revised October 2023

ENGINEER'S CERTIFICATION

I, Hereby certify that I am a registered professional engineer in the State of Florida, practicing with Traf Tech Engineering, Inc., a Florida Corporation under Section 471.023, Florida Statutes, to offer engineering services to the public through a Professional Engineer, duly licensed under Chapter 471, Florida Statues, Professional License Number 44174, by the State of Florida, Department of Professional Regulation, Board of Professional Engineers, and that I have prepared or approved the evaluation, findings, opinions, conclusions, or technical advice hereby reported for:

Project: Nove of Margate
Location: Margate, Florida 33063
Client: Fimiani Development Corporation

Report Prepared by: Traf Tech Engineering, Inc
8400 N. University Drive, Suite 309
Tamarac, Florida 33321

I acknowledge that the procedures and references used to develop the results contained in this report are standards to the professional practice of transportation engineering as applied through professional judgement and experience.

Signature:
Name:
License No.
Date:



Joaquin E. Vargas, P.E.
FL 44174
October 18, 2023



October 18, 2023

October 18, 2023

Mr. Michael Fimiani
Fimiani Development Corporation
5301 North Federal Highway, Suite 350
Boca Raton, Florida 33487

Re: **Nove of Margate - Traffic Study**

Dear Mike:

Traf Tech Engineering, Inc. is pleased to provide you with the results of the traffic evaluation associated with the proposed residential development planned to be located on the south side of Margate Boulevard just west of NW 76th Avenue in Margate, Broward County, Florida. Figure 1 shows the location of the project site.

Project Description and Access

The project will replace a golf course with 132 residential units. Access to the site is planned via one access driveway off of Margate Boulevard. Appendix A contains the site plan associated with the proposed development. For purposes of this traffic evaluation, the project is anticipated to be built and occupied in the year 2025. The following tasks were undertaken as part of this evaluation:

- Documented the existing lane geometry of the study area. Ten (10) intersections and the project driveway were identified as the locations that will be impacted the most by the proposed project. These intersections include Rock Island Road at Royal Palm Boulevard, at Margate Boulevard, at Atlantic Boulevard, and at South Gate Boulevard. SR 7 at Margate Boulevard and at Atlantic Boulevard. Atlantic Boulevard at Riverside Drive, at Ramblewood Drive, and at NW 76th Avenue. Figure 2 illustrates the existing lane geometry of the study intersections.
- Collected intersection turning movement counts during the critical peak periods (7:00 AM to 9:00 AM) and (4:00 PM to 6:00 PM) at the following locations:
 1. Rock Island Road & Royal Palm Boulevard (signalized)
 2. NW 76 Avenue & Margate Boulevard (stop controlled)
 3. Rock Island Road & Margate Boulevard (signalized)
 4. SR 7 & Margate Boulevard (signalized)

5. Riverside Drive & Atlantic Boulevard (signalized)
6. Ramblewood Drive & Atlantic Boulevard (signalized)
7. NW 76 Avenue & Atlantic Boulevard (signalized)
8. Rock Island Road & Atlantic Boulevard (signalized)
9. SR 7 & Atlantic Boulevard (signalized)
10. Southgate Boulevard & Rock Island Road (signalized)
11. Atlantic Boulevard & NW 66 Avenue (signalized)
12. Margate Boulevard & NW 66 Avenue (AWSC)

The above traffic counts were recorded on Wednesday, May 11, 2022 and Wednesday, April 26, 2023. Figure 3 documents the existing traffic counts. The traffic counts were collected during the peak season based on FDOT's peak season adjustment factors. The traffic counts are included in Appendix B as well as the signal timing plans for the signalized intersections. The peak season adjustment factors and historical traffic counts are provided in Appendix C.

- o A trip generation analysis was performed using the trip generation equations published in the Institute of Transportation Engineer's (ITE) Trip Generation Manual (11th Edition). The trip generation analysis was undertaken for daily, AM peak hour, and PM peak hour conditions. Table 1 summarizes the trip generation analyses.

TABLE 1 Trip Generation Summary Novel of Margate								
Land Use	Size	Daily Trips	AM Peak Hour			PM Peak Hour		
			Total Trips	Inbound	Outbound	Total Trips	Inbound	Outbound
Residential Low-Rise (LUC 220)	132 units	921	64	15	49	77	49	28
Net External Trips	132 units	921	64	15	49	77	49	28

Source: ITE Trip Generation Manual (11th Edition)

ITE Land Use Code 220 - Multifamily (Low-Rise)

Daily Trips: $T = 6.41(X) + 75.31$, X = number of units

AM Peak: $T = 0.31(X) + 22.85$ (24% inbound and 76% outbound), X = number of units

PM Peak: $T = 0.43(X) + 20.55$ (63% inbound and 37% outbound), X = number of units

ITE Land Use Code 221 - Multifamily (Mid-Rise)

Daily Trips: $T = 4.77(X) - 46.46$, X = number of units

AM Peak: $T = 0.44(X) - 11.61$ (23% inbound and 77% outbound), X = number of units

PM Peak: $T = 0.39(X) - 0.34$ (61% inbound and 39% outbound), X = number of units

As indicated in Table 1, the proposed development is projected to generate approximately 921 daily trips, approximately 64 AM peak hour trips (15 inbound and 49 outbound) and approximately 77 trips during the typical afternoon peak period (49 inbound and 28 outbound). It is important to note that even though the existing golf course is generating traffic, no deduction was applied to account for the existing trips associated with the golf course (conservative approach).

- The project's peak-hour trips documented in Table 1 were distributed and assigned to the access driveways based on knowledge of the study area, examination of the surrounding roadway network characteristics, review of current traffic volumes, and existing land use patterns. The trip distribution assumed for the subject development is summarized below:
 - 5% to and from the east via Royal Palm Boulevard
 - 5% to and from the west via Royal Palm Boulevard
 - 20% to and from the east via Atlantic Boulevard
 - 15% to and from the west via Atlantic Boulevard
 - 5% to and from the east via Southgate Boulevard
 - 3% to and from the west via Southgate Boulevard
 - 3% to and from the north via Riverside Drive
 - 2% to and from the south via Riverside Drive
 - 2% to and from the north via Ramblewood Drive
 - 5% to and from the north via Rock Island Road
 - 5% to and from the south via Rock Island Road
 - 15% to and from the north via SR 7
 - 15% to and from the south via SR 7

Figure 4 documents the project traffic assignment based on the above traffic percentages.

- Figures 5 and 6 present the future traffic volumes for the study area. Figure 5 includes background traffic only (without the proposed project) and Figure 6 includes the additional traffic anticipated to be generated by the proposed development. The background traffic includes traffic growth based on historical traffic data within the study area (refer to Appendix D). As indicated in the growth analysis presented in Appendix D, traffic growth has occurred over the past five (5) years (2015-2019). Based on the analysis, a 2.89% growth rate, compounded annually was applied to the existing traffic counts to account for future increases in traffic volumes. The future traffic volumes are presented in Appendix E in tabular format.
- To determine the impacts created to the study intersections, capacity/level of service analyses were undertaken using the SYNCHRO software. The results of the capacity/level of service analyses are presented in Table 2 on Page 8. As summarized in Table 2, the traffic impacts created by the project are insignificant (less than 2.0 seconds of additional delay to the most-impacted intersection. Therefore, no roadway improvements are required as a result of this project. Moreover, minor signal timing optimization is

recommended to the intersections of Rock Island Road/Royal Palm Boulevard, Riverside Drive/Atlantic Boulevard, Rock Island Road/Atlantic Boulevard, SR 7/Atlantic Boulevard and Rock Island Road/Southgate Boulevard.

Since the signalized intersections are fully actuated (they have vehicle detectors to vary the amount of green time provided based on the amount of vehicles for each movement, changes in traffic volumes/patterns are taken into account in the analysis by optimizing the signal timing to obtain minimal delay due to the project's traffic impacts.

- The project driveway is also expected to operate adequately. As indicated in the SYNCHRO analyses, the maximum westbound left-turn queue expected at the project driveway is minimal (50 feet). The SYNCHRO outputs are contained in Appendix F.

Roadway Level of Service

The following section pertains to only North American highway LOS standards as in the Highway Capacity Manual (HCM) and AASHTO Geometric Design of Highways and Streets ("Green Book"), using letters A through F, with A being the best and F being the worst, similar to academic grading.

A: free flow. Traffic flows at or above the posted speed limit and motorists have complete mobility between lanes. The average spacing between vehicles is about 550 ft (167m) or 27 car lengths. Motorists have a high level of physical and psychological comfort. The effects of incidents or point breakdowns are easily absorbed. LOS A generally occurs late at night in urban areas and frequently in rural areas.

B: reasonably free flow. LOS A speeds are maintained, maneuverability within the traffic stream is slightly restricted. The lowest average vehicle spacing is about 330 ft (100 m) or 16 car lengths. Motorists still have a high level of physical and psychological comfort.

C: stable flow, at or near free flow. The ability to maneuver through lanes is noticeably restricted and lane changes require more driver awareness. Minimum vehicle spacing is about 220 ft (67 m) or 11 car lengths. Most experienced drivers are comfortable, roads remain safely below but efficiently close to capacity, and posted speed is maintained. Minor incidents may still have no effect but localized service will have noticeable effects and traffic delays will form behind the incident. This is the target LOS for some urban and most rural highways.

D: approaching unstable flow. Speeds slightly decrease as traffic volume slightly increases. Freedom to maneuver within the traffic stream is much more limited and driver comfort levels decrease. Vehicles are spaced about 160 ft(50m) or 8 car lengths. Minor incidents are expected to create delays. Examples are a busy shopping corridor in the middle of a weekday, or a functional urban highway during commuting hours. It is a common goal for urban streets during peak hours, as attaining LOS C would require prohibitive cost and societal impact in bypass roads and lane additions.

E: unstable flow, operating at capacity. Flow becomes irregular and speed varies rapidly because there are virtually no usable gaps to maneuver in the traffic stream and speeds rarely reach the posted limit. Vehicle spacing is about 6 car lengths, but speeds are still at or above 50 mi/h (80 km/h). Any disruption to traffic flow, such as merging ramp traffic or lane changes, will create a shock wave affecting traffic upstream. Any incident will create serious delays. Drivers' level of comfort becomes poor.^[1] This is a common standard in larger urban areas, where some roadway congestion is inevitable.

F: forced or breakdown flow. Every vehicle moves in lockstep with the vehicle in front of it, with frequent slowing required. Travel time cannot be predicted, with generally more demand than capacity. A road in a constant traffic jam is at this LOS, because LOS is an average or typical service rather than a constant state. For example, a highway might be at LOS D for the AM peak hour, but have traffic consistent with LOS C some days, LOS E or F others, and come to a halt once every few weeks.

Analysis Results Discussion

Rock Island Road and Royal Palm Boulevard – This intersection is currently operating at level of service “F” and will continue to operate at level of service “F” in the year 2025 with or without the Nove of Margate project in place. The increase in delay due to the proposed project is less than two (2) seconds (de-minimus traffic impacts)

NW 76th Avenue and Margate Boulevard - This intersection is operating adequately in the AM and PM peak hours and is projected to function at an acceptable level of service in the year 2025 with and without the Nove of Margate project in place, during both peak hours.

Rock Island Road and Margate Boulevard - This intersection is operating adequately in the AM and PM peak hours and is projected to function at an

acceptable level of service in the year 2025 with and without the Nove of Margate project in place, during both peak hours.

State Road 7 and Margate Boulevard - This intersection is operating adequately in the AM and PM peak hours and is projected to function at an acceptable level of service in the year 2025 with and without the Nove of Margate project in place, during both peak hours.

Riverside Drive and Atlantic Boulevard - During the AM peak hour, this intersection is currently operating at level of service "F" and will continue to operate at level of service "F" in the year 2025 with or without the Nove of Margate project in place. However, the project's traffic impacts are minimal and can be mitigated with signal timing optimization.

During the PM peak hour, this intersection is currently operating at level of service "E" and will continue to operate at level of service "E" in the year 2025 with or without the Nove of Margate project in place. However, the project's traffic impacts are minimal and can be mitigated with signal timing optimization.

Ramblewood Drive and Atlantic Boulevard - This intersection is operating adequately in the AM and PM peak hours and is projected to function at an acceptable level of service in the year 2025 with and without the Nove of Margate project in place, during both peak hours.

NW 76th Avenue and Atlantic Boulevard - This intersection is operating adequately in the AM and PM peak hours and is projected to function at an acceptable level of service in the year 2025 with and without the Nove of Margate project in place, during both peak hours.

Rock Island Road and Atlantic Boulevard - During the AM peak hour, this intersection is currently operating at level of service "E" and will continue to operate at level of service "E" in the year 2025 with or without the Nove of Margate project in place. However, the project's traffic impacts are minimal and can be mitigated with signal timing optimization.

During the PM peak hour, this intersection is currently operating at level of service "E" and will continue to operate at level of service "E" in the year 2025 with or without the Nove of Margate project in place. However, the project's traffic impacts are minimal and can be mitigated with signal timing optimization.

State Road 7 and Atlantic Boulevard – During the AM peak hour, this intersection is currently operating at level of service “E” and will continue to operate at level of service “E” in the year 2025 with or without the Nove of Margate project in place. However, the project’s traffic impacts are minimal and can be mitigated with signal timing optimization.

During the PM peak hour, this intersection is currently operating at level of service “E”. In the year 2025, this intersection is projected to operate at level of service “F” in the year 2025 with or without the Nove of Margate project in place. However, the project’s traffic impacts are minimal and can be mitigated with signal timing optimization.

Southgate Boulevard and Rock Island Road - During the AM peak hour, this intersection is currently operating at level of service “E” and will continue to operate at level of service “E” in the year 2025 with or without the Nove of Margate project in place. However, the project’s traffic impacts are minimal and can be mitigated with signal timing optimization.

This intersection is operating adequately in the PM peak hour and is projected to function at an acceptable level of service in the year 2025 with and without the Nove of Margate project in place.

NW 66 Avenue and Atlantic Boulevard - This intersection is operating adequately in the AM and PM peak hours and is projected to function at an acceptable level of service in the year 2025 with and without the Nove of Margate project in place, during both peak hours.

NW 66 Avenue and Margate Boulevard - This intersection is operating adequately in the AM and PM peak hours and is projected to function at an acceptable level of service in the year 2025 with and without the Nove of Margate project in place, during both peak hours.

In summary, the proposed development is projected to generate approximately 921 daily trips, approximately 64 AM peak hour trips and approximately 77 trips during the typical afternoon peak period. The project driveway is projected to operate at level of service “A” as proposed. It is recommended that the development team contact Broward County Traffic Engineering Division to request that the signal timing of the five intersections described previously be optimized, if necessary, by Broward County Traffic Engineering Division after the project is built and occupied.

Please give me a call if you have any questions.

Sincerely,

TRAF TECH ENGINEERING, INC.

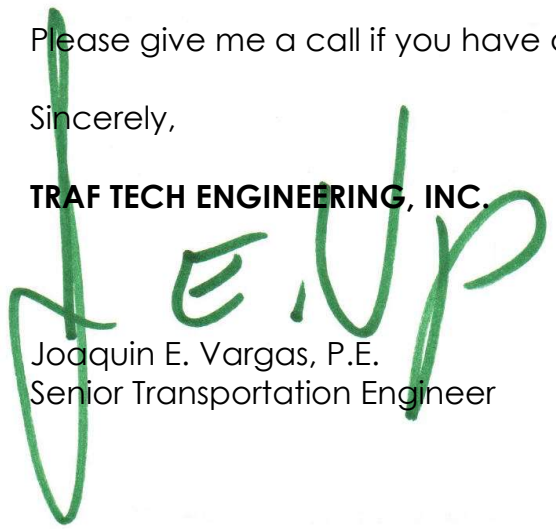
A handwritten signature in green ink, appearing to read 'J. E. Vargas', is written over the printed name and title.

Joaquin E. Vargas, P.E.
Senior Transportation Engineer

TABLE 2
Intersection Level of Service
Novel of Margate Townhomes

Intersection	2022 Existing		2025 Background without Project		2025 Future with Project	
	LOS	Delay (sec)	LOS	Delay (sec)	LOS	Delay (sec)
101: Rock Island Road & Royal Palm Boulevard**	F/F	83.6/78.1	F/F	101.3/86.0	F/F	102.0/86.8
102: NW 76 Avenue & Margate Boulevard -NB	A/B	9.7/11.3	A/B	9.9/11.8	B/B	10.3/12.8
103: Rock Island Road & Margate Boulevard	B/B	14.8/18.0	B/B	15.3/18.5	B/B	15.7/18.9
104: SR 7 & Margate Boulevard*	C/B	28.0/14.9	C/B	30.6/16.4	C/B	30.8/16.5
105: Riverside Drive & Atlantic Boulevard	F/E	87.9/65.2	F/E	103.1/76.3	F/E	102.9/76.3
106: Ramblewood Drive & Atlantic Boulevard	B/A	10.1/5.4	B/A	10.8/5.8	B/A	10.8/5.8
107: NW 76 Avenue & Atlantic Boulevard	A/A	9.2/9.0	A/A	9.4/9.4	B/B	10.2/10.3
108: Rock Island Road & Atlantic Boulevard	E/E	57.9/62.9	E/E	63.2/73.8	E/E	63.4/74.4
109: SR 7 & Atlantic Boulevard	E/E	63.9/72.2	E/F	77.4/88.9	E/F	77.7/89.9
110: Southgate Boulevard & Rock Island Road	E/D	60.4/47.3	E/D	71.0/53.6	E/D	71.2/53.9
111: NW 66 Avenue & Atlantic Boulevard**	B/B	16.3/18.3	B/B	17.1/19.8	B/B	17.1/19.8
112: NW 66 Avenue & Margate Boulevard**	B/B	14.6/13.0	C/B	16.1/14.0	C/B	16.4/14.1
201: Driveway & Margate Blvd -NB WBL Queue (bay 75')	N/A	N/A	N/A	N/A	A/A	8.8/8.6 0'/2'

Notes: AM/PM *HCM 2000; ** 2023 Count

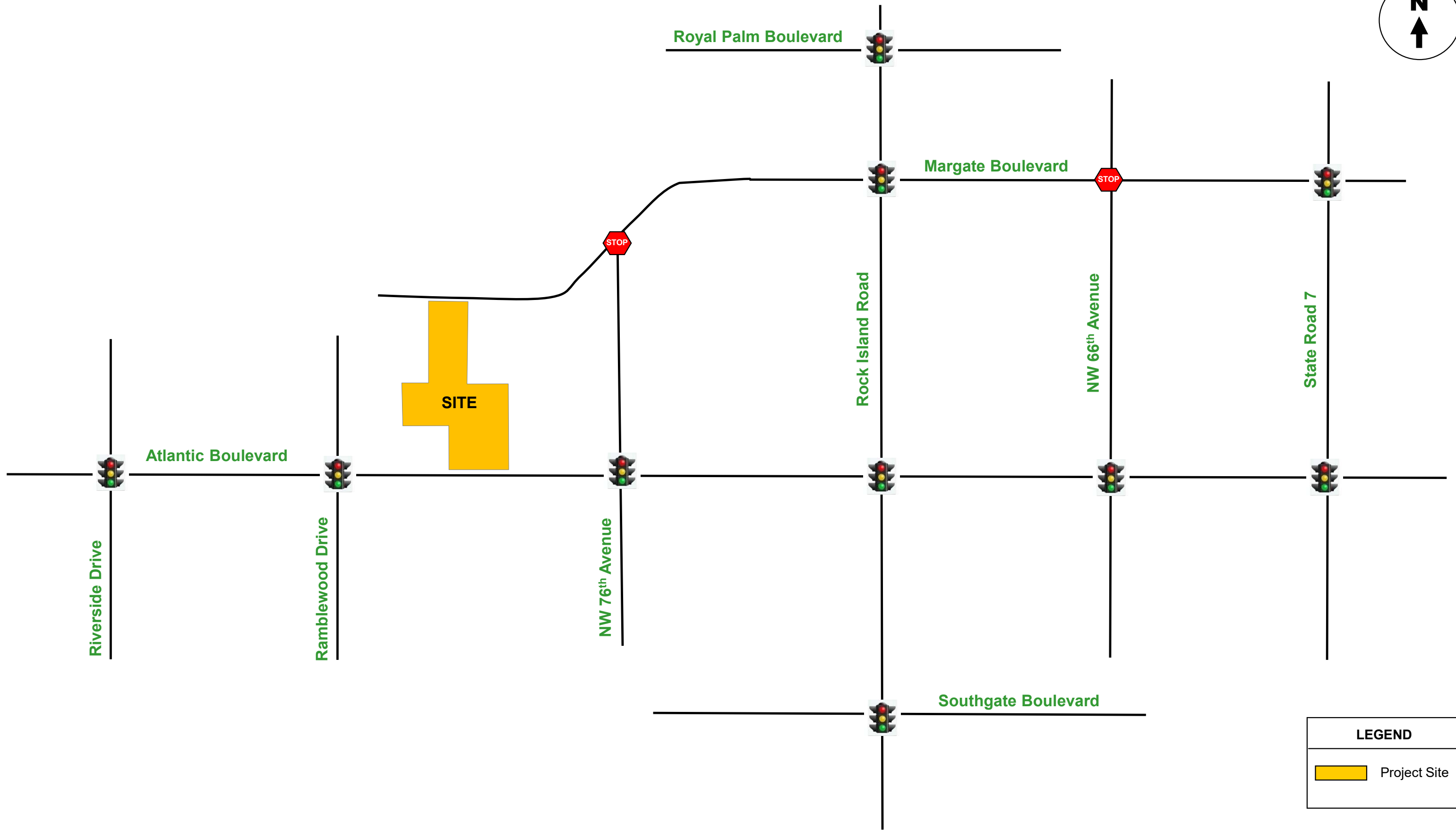
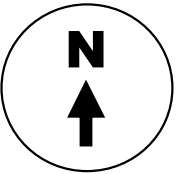

LEGEND	
	Project Site

LOCATION MAP

FIGURE 1
Nove of Margate
Tamarac, Florida

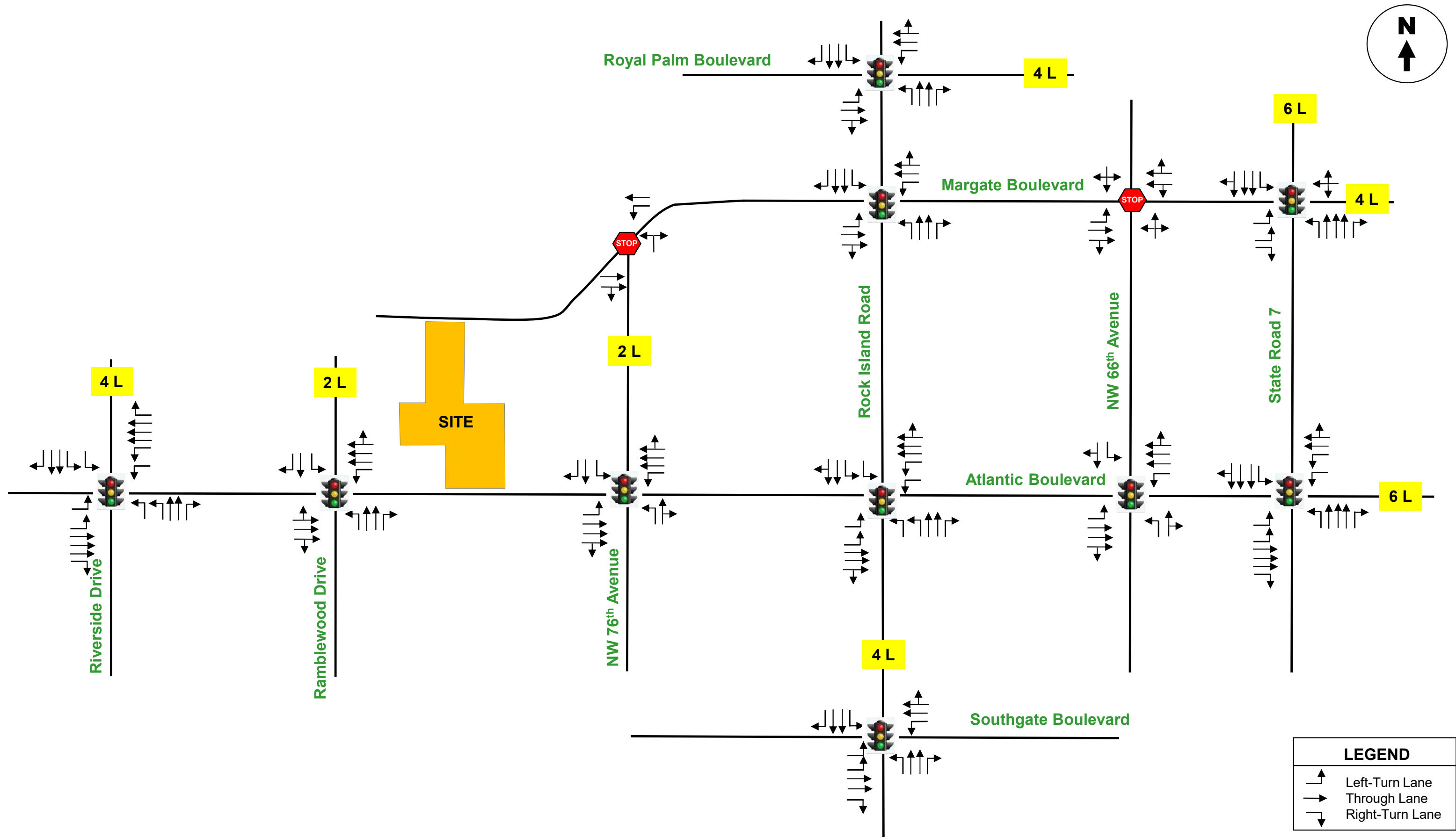

LEGEND	
	Left-Turn Lane
	Through Lane
	Right-Turn Lane

EXISTING LANE GEOMETRY

FIGURE 2
Novena of Margate
Tamarac, Florida

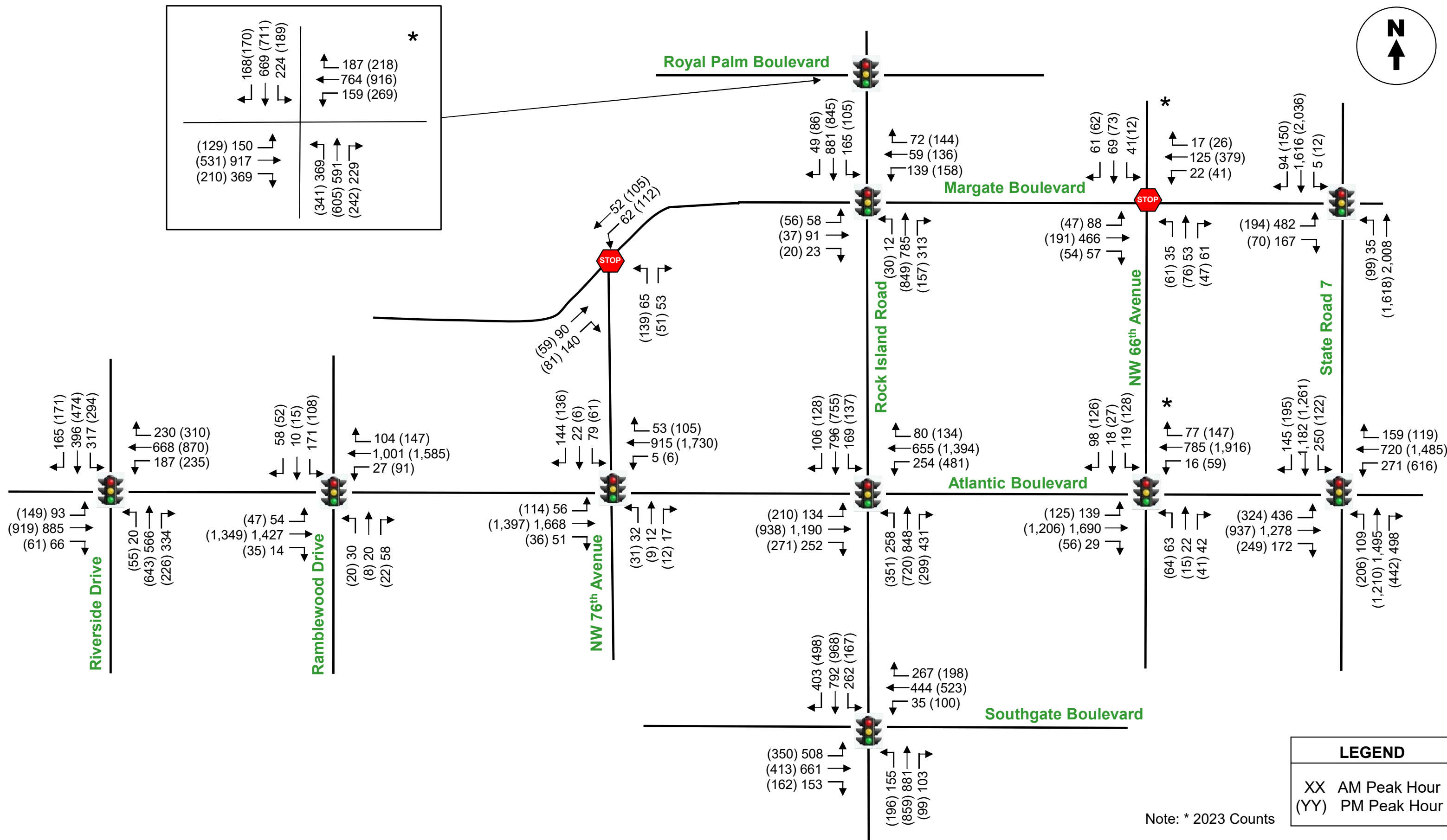

TRAFFIC COUNTS
(Year 2022 and 2023 Peak Season)

FIGURE 3
Nové of Margate
Tamarac, Florida

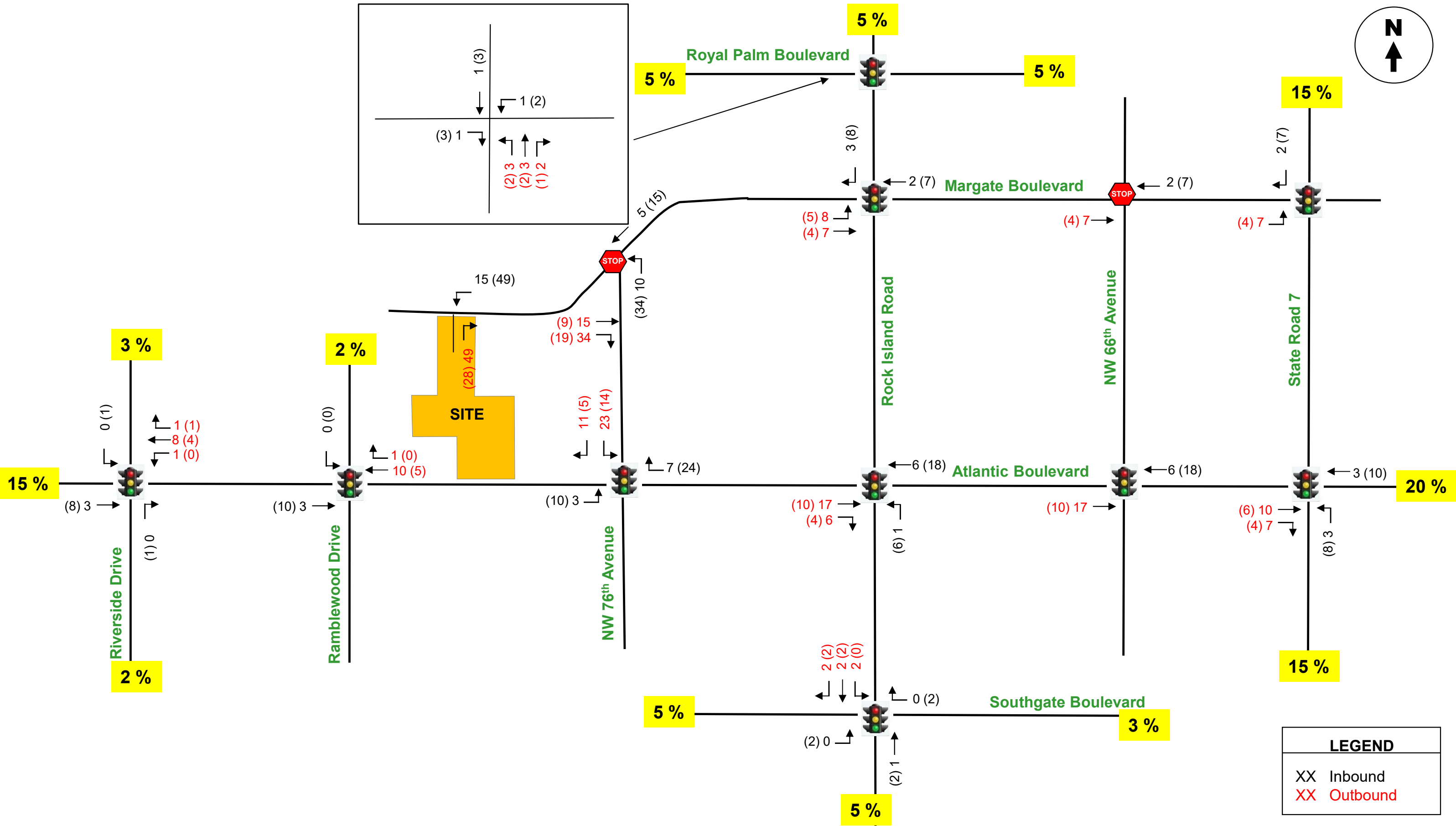
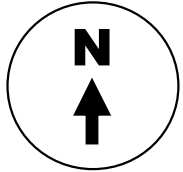

PROJECT TRIP DISTRIBUTION

FIGURE 4
Nove of Margate
Tamarac, Florida

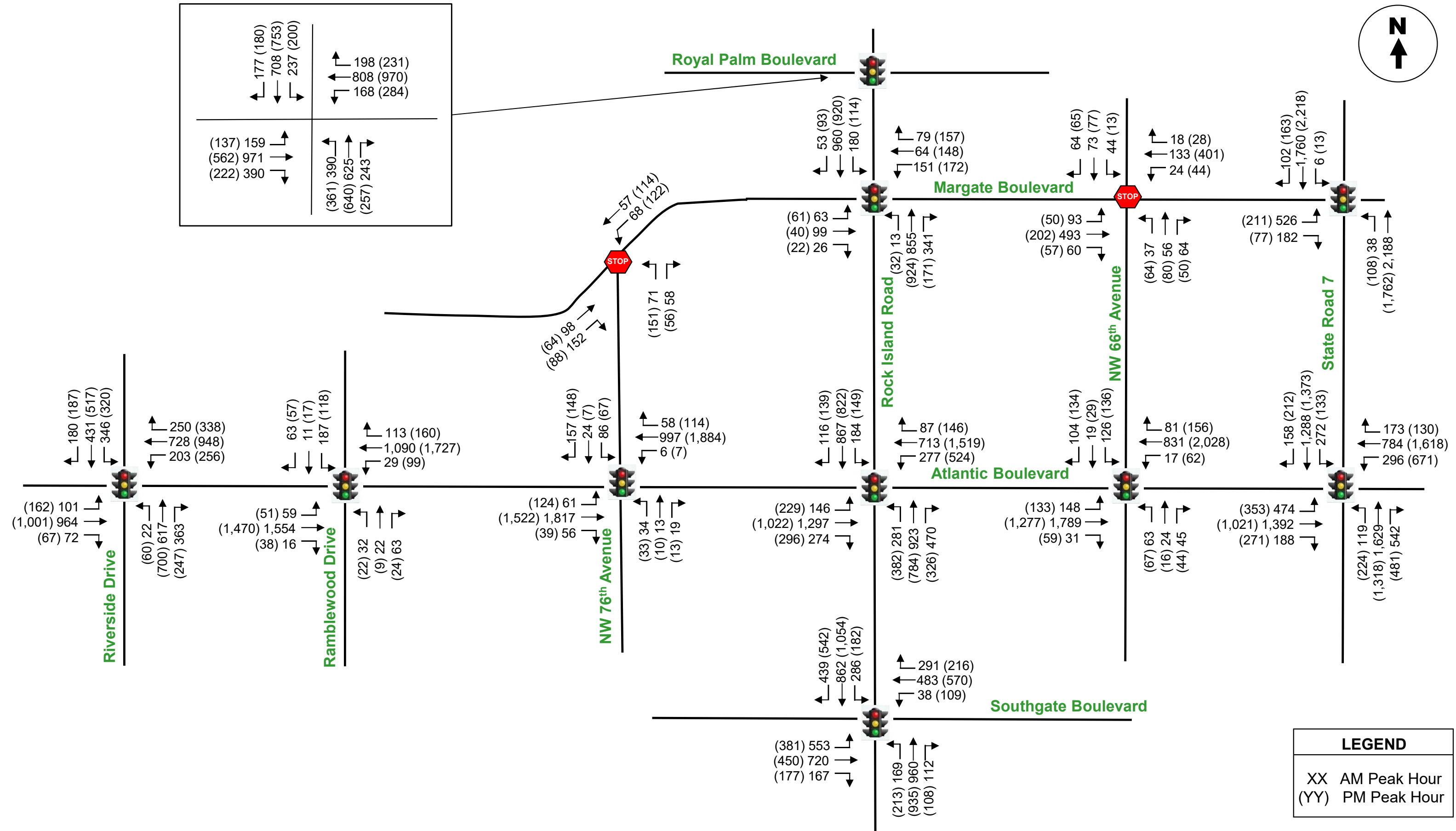
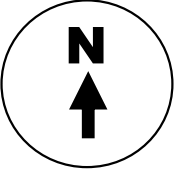
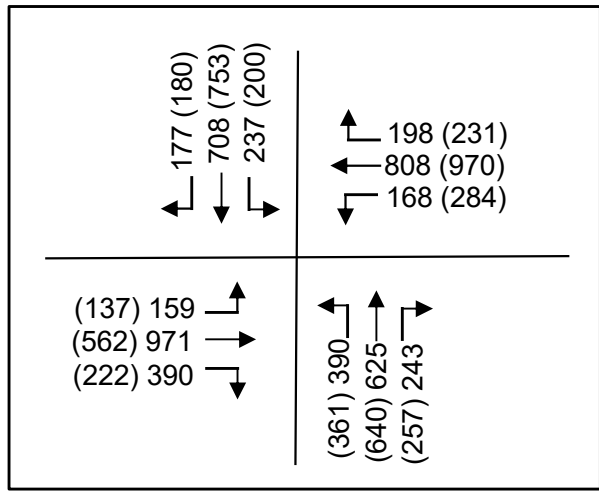

LEGEND	
XX	AM Peak Hour
(YY)	PM Peak Hour

BACKGROUND TRAFFIC – Year 2025
AM & (PM) Peak Hour

FIGURE 5
 Nove of Margate
 Tamarac, Florida



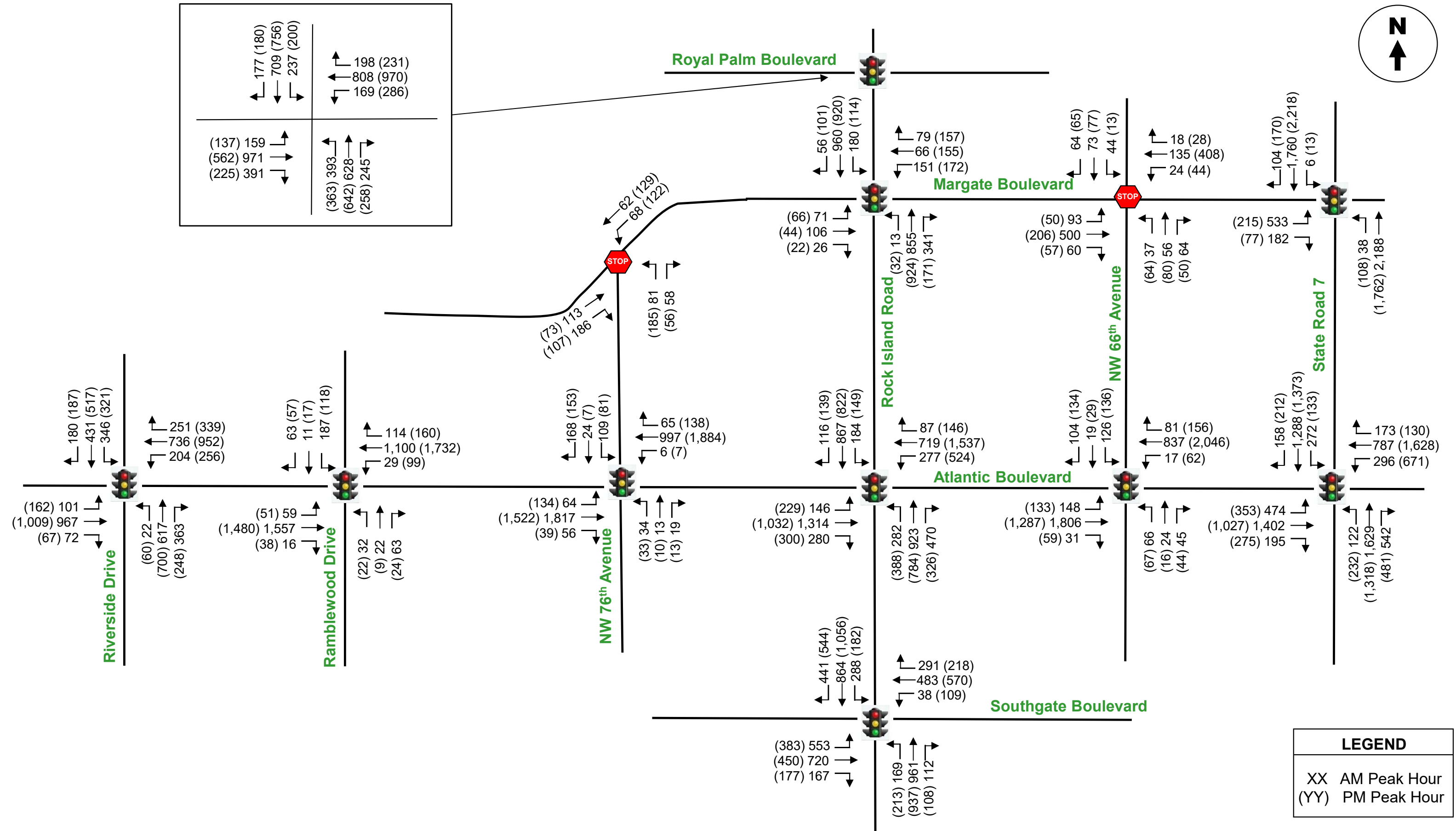
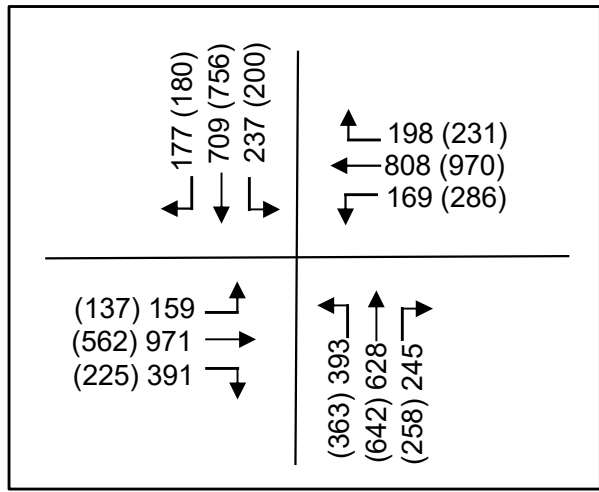

LEGEND	
XX	AM Peak Hour
(YY)	PM Peak Hour

**TOTAL TRAFFIC VOLUMES
(Year 2025 Peak Season)**

FIGURE 6
Nove of Margate
Tamarac, Florida



APPENDIX A

Site Plan Nove of Margate

SITE PLAN
FOR

Nove of Margate

Margate, Florida

LEGAL DESCRIPTION

PARCEL 3, "ORIOLE GOLF AND TENNIS CLUB SECTION TWO", ACCORDING TO THE PLAT THEREOF AS RECORDED IN PLAT BOOK 78, PAGE 21, OF THE PUBLIC RECORDS OF BROWARD COUNTY, FLORIDA.

TOGETHER WITH:

A PORTION OF PARCEL 4 OF SAID PLAT, "ORIOLE GOLF AND TENNIS CLUB SECTION TWO", ACCORDING TO THE PLAT THEREOF, AS RECORDED IN PLAT BOOK 78, PAGE 21, OF THE PUBLIC RECORDS OF BROWARD COUNTY, FLORIDA, MORE PARTICULARLY DESCRIBED AS FOLLOWS:

COMMENCING AT THE NORTHWEST CORNER OF SECTION 35, TOWNSHIP 48 SOUTH, RANGE 41 EAST; THENCE SOUTH 00°03'23" WEST, 292.60 FEET ALONG THE WEST BOUNDARY OF SAID SECTION TO THE POINT OF INTERSECTION WITH THE SOUTH RIGHT-OF-WAY LINE OF MARGATE BLVD. ACCORDING TO SAID PLAT; THENCE ALONG SAID SOUTH RIGHT-OF-WAY LINE OF MARGATE BLVD. THE FOLLOWING FOUR (4) COURSES: SOUTH 89°56'37" EAST, 15.94 FEET; THENCE ALONG THE ARC OF A TANGENT CURVE, BEING CONCAVE TO THE SOUTHWEST, HAVING A RADIUS OF 664.05 FEET, A DELTA OF 39°51'40", AN ARC DISTANCE OF 461.98 FEET; THENCE TANGENT TO SAID CURVE SOUTH 50°04'57" EAST, 725.16 FEET; THENCE ALONG THE ARC OF A TANGENT CURVE, CONCAVE TO THE NORTHEAST, HAVING A RADIUS OF 776.33 FEET, A DELTA OF 22°15'10", AN ARC DISTANCE OF 301.52 FEET TO THE NORTHEAST CORNER OF SAID PARCEL 3 AND THE POINT OF BEGINNING; THENCE CONTINUE ALONG SAID CURVE, HAVING A RADIUS OF 776.33 FEET, A DELTA OF 11°58'05", AN ARC DISTANCE OF 162.16 FEET (THE PRECEDING COURSE BEING COINCIDENT WITH THE SAID SOUTH RIGHT-OF-WAY LINE OF MARGATE BLVD.); THENCE SOUTH 20°36'41" WEST, 134.67 FEET; THENCE NORTH 88°35'00" WEST, 115.00 FEET TO A POINT OF THE EAST LINE OF SAID PARCEL 3, THENCE NORTH 01°25'00" EAST ALONG THE EAST LINE OF SAID PARCEL 3, A DISTANCE OF 156.02 FEET TO THE POINT OF BEGINNING.

SAID LANDS SITUATE IN THE CITY OF MARGATE, BROWARD COUNTY, FLORIDA AND CONSISTS OF 21.302 ACRES MORE OR LESS.

DEVELOPMENT TEAM

DEVELOPER: Fimiani Development Corporation
5301 North Federal Highway, Suite 350
Boca Raton, Florida 33487
Phone: 561-395-8882

**LAND USE ATTORNEY/
LAND PLANNER:** Dunay, Miskel and Backman, LLP
14 SE 4th Street, Suite 36
Boca Raton, Florida 33432
Phone: 561-405-3300

**ENGINEER/
PLANNER:** Schnars Engineering Corporation
947 Clint Moore Road
Boca Raton, Florida 33487
Phone: 561-241-6455

ARCHITECT: A B Design Group
1441 N. Ronald Reagan Boulevard
Longwood, Florida 32750
Phone: 407-774-6078

LANDSCAPE ARCHITECT: Peterson Design Professionals
151 Southwest 7th Terrace
Boca Raton, Florida 33486
Phone: 561-702-0136

PHOTOMETRIC ENGINEER: Lightworks, Inc.
7447 NW 48th Street, Suite B
Miami, Florida 33166
Phone: 561-641-5570

OWNER:

Margate Executive Golf Course, LLC
5301 North Federal Highway, Suite 350
Boca Raton, Florida 33487

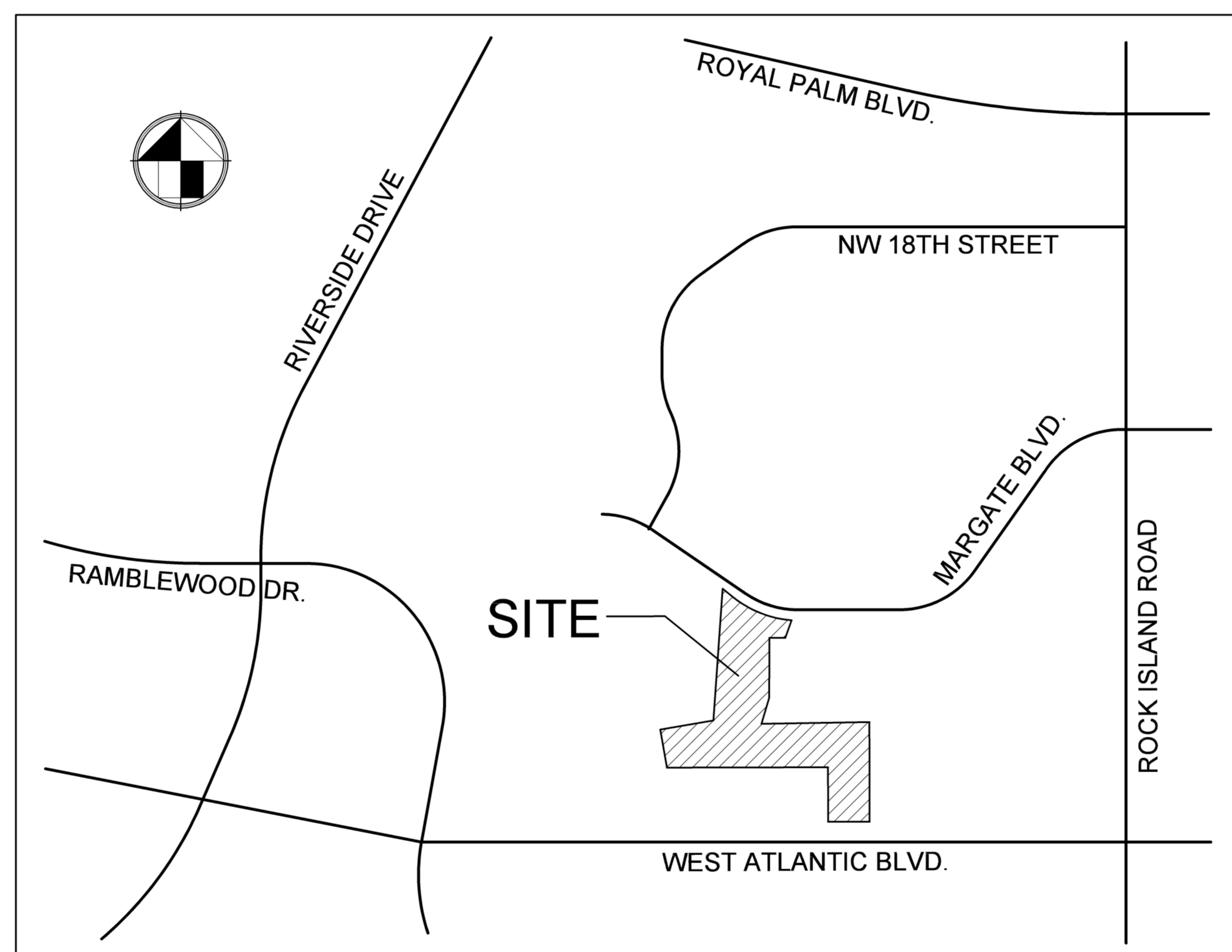

LOCATION MAP
S 35, T 48S, R 41E
NOT TO SCALE

INDEX OF SHEETS

<u>SHEET DESCRIPTION</u>	<u>SHEET NO.</u>
MASTER SITE PLAN	SP1
SITE PLAN	SP2 - SP4
SITE PLAN DETAILS	SP5
OPEN SPACE EXHIBIT	SP6

SCHNARS
ENGINEERING CORPORATION

947 CLINT MOORE ROAD • BOCA RATON, FLORIDA 33487

TEL: (561) 241-6455 • FAX: (561) 241-5182

CERTIFICATE OF AUTHORIZATION No. 6640

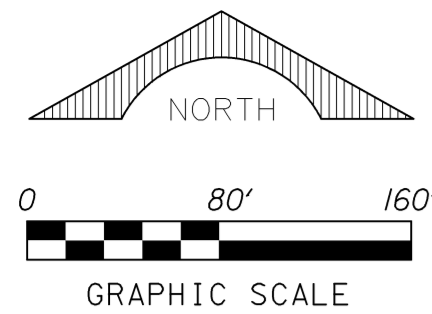

SHEET 2

SHEET 3

SHEET 4

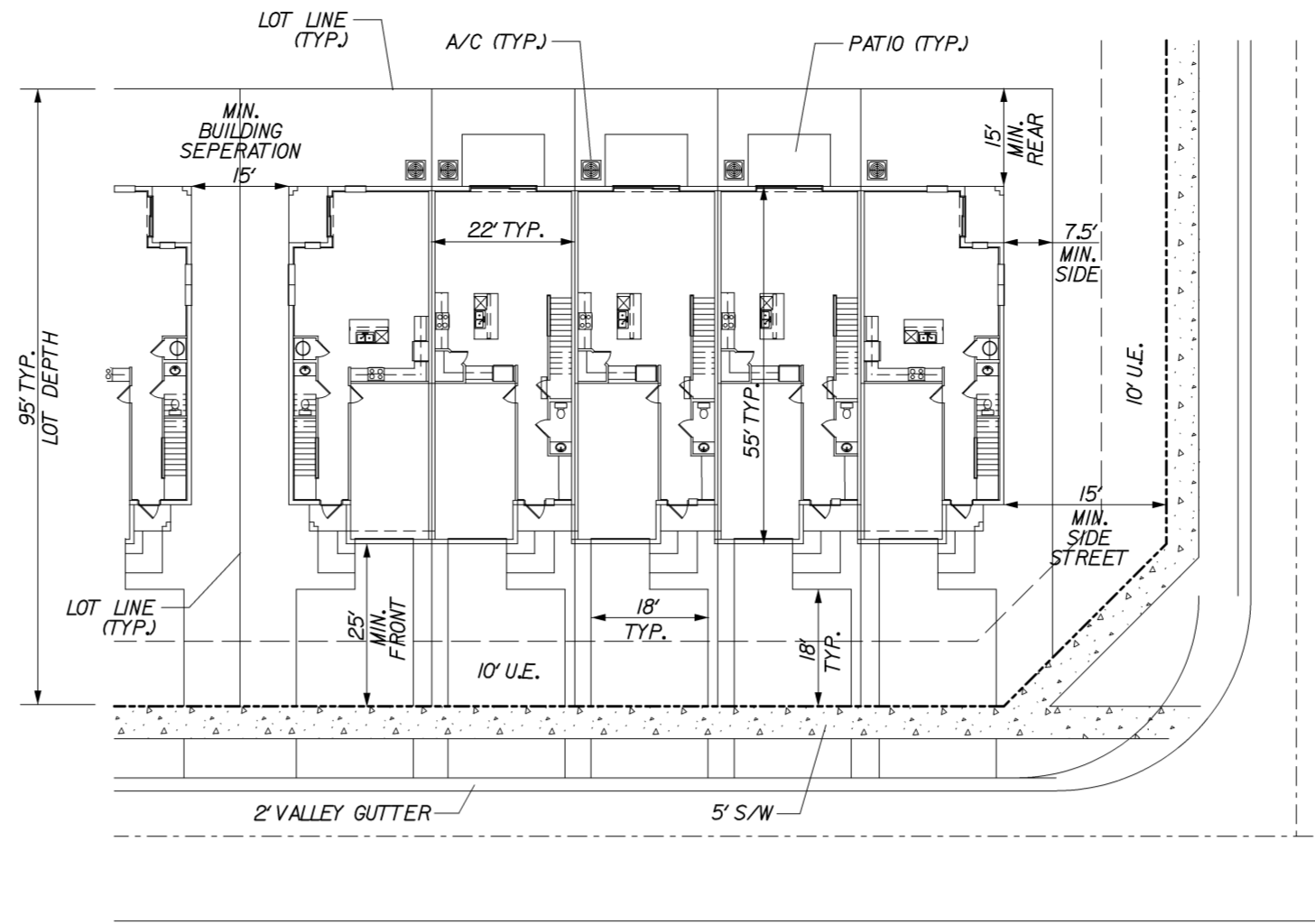
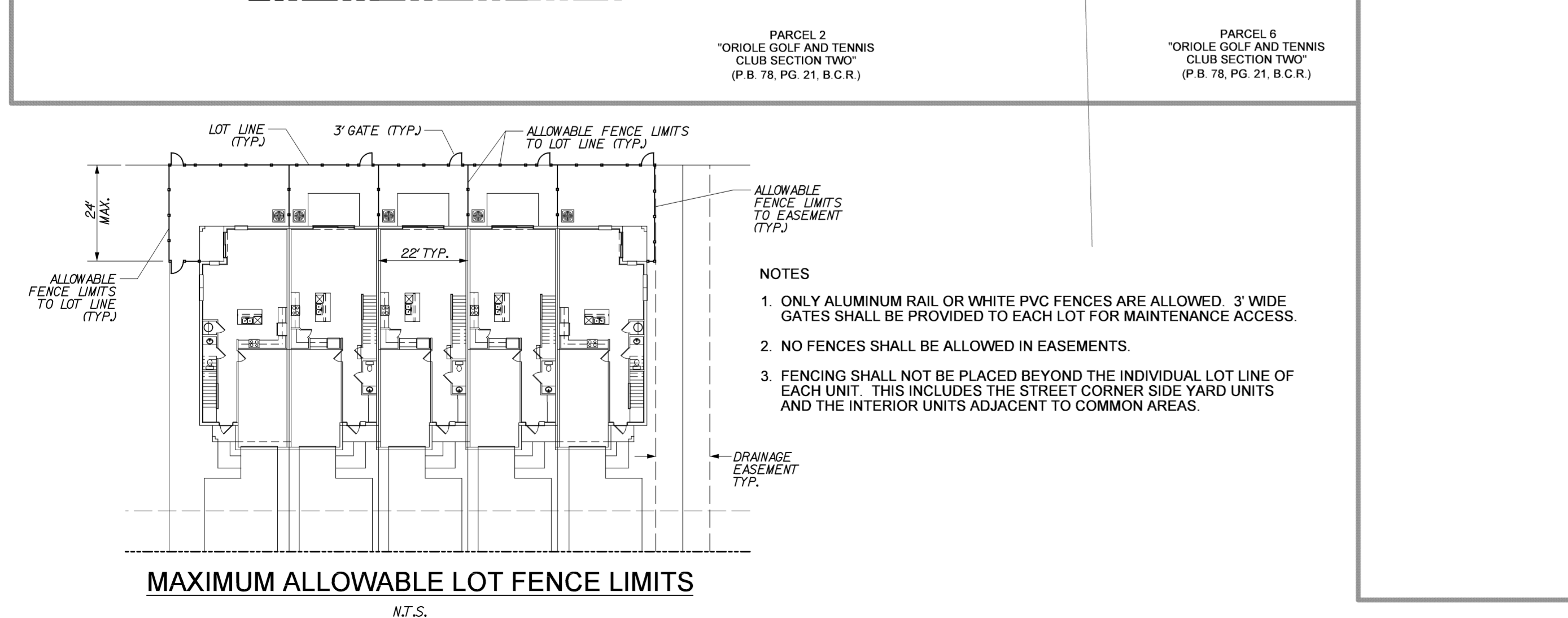
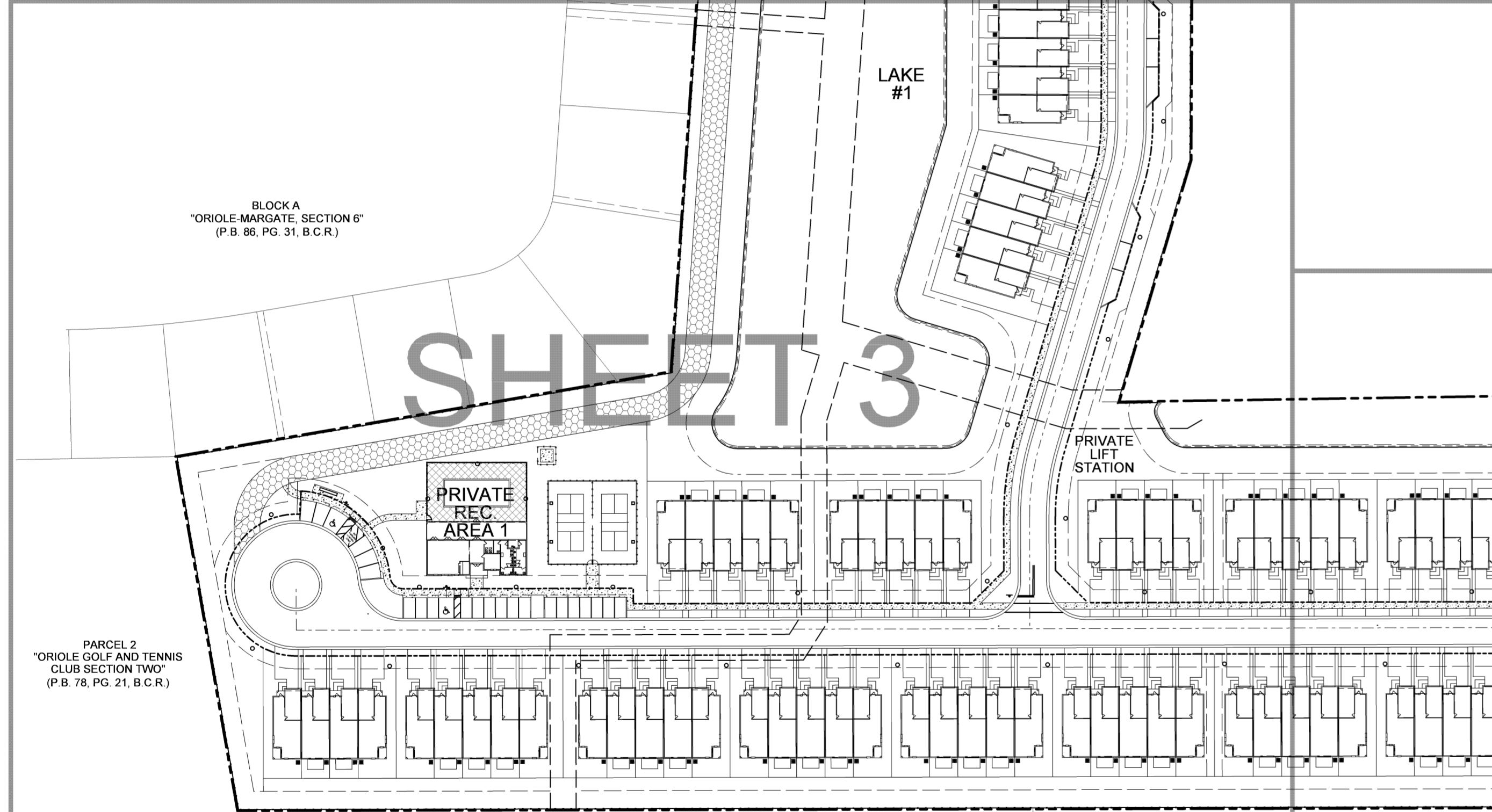
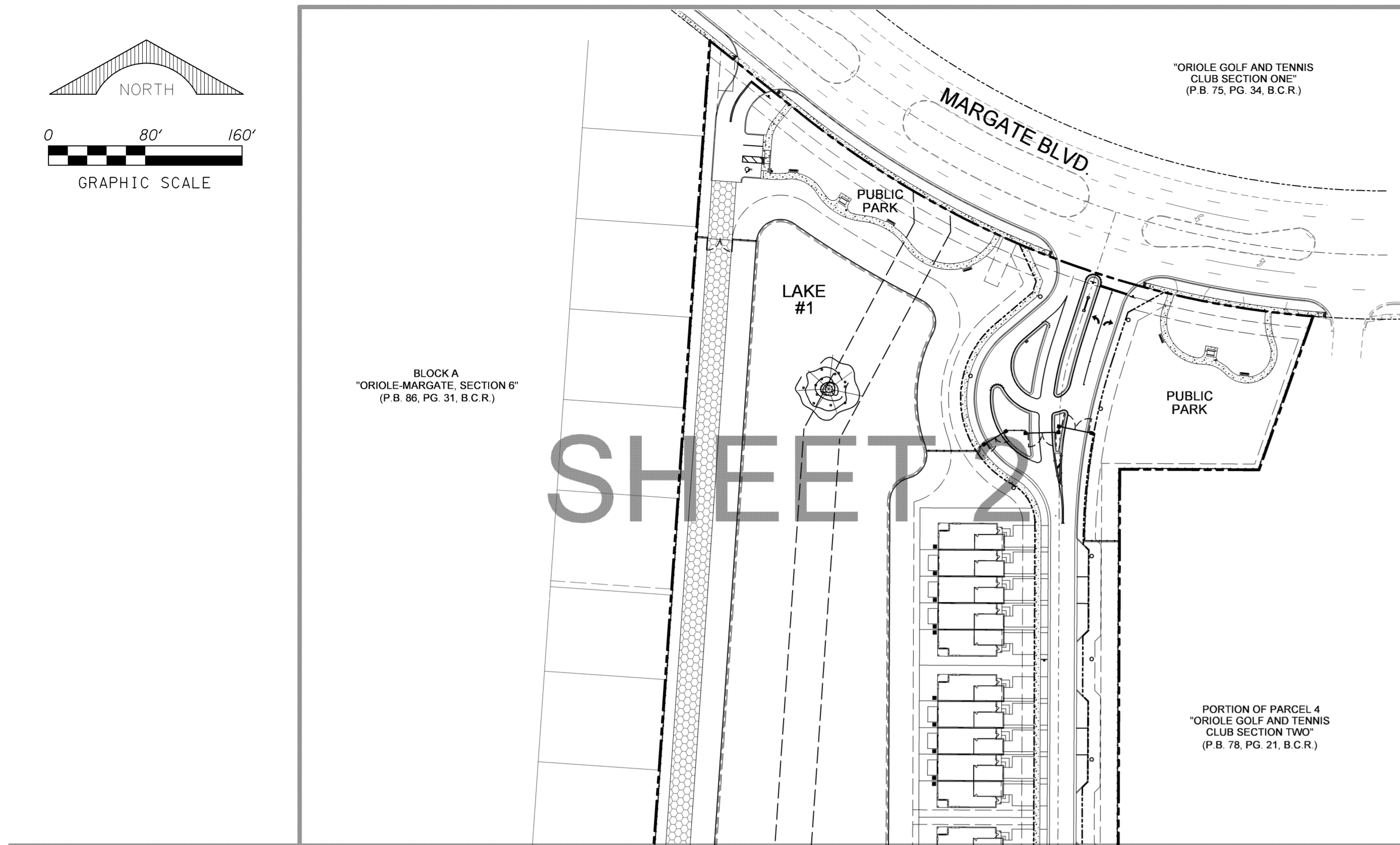

TYPICAL BUILDING DETAIL
N.T.S.

LOT DEVELOPMENT REGULATIONS

BUILDING HEIGHT:	2 STORIES / 35' MAX.
LOT WIDTH:	22 FT MIN.
BUILDING SETBACKS:	
FRONT WITH FRONT LOAD GARAGE:	25' MIN.
SIDE (INTERIOR):	0' MIN.
SIDE (END UNIT):	7.5' MIN.
SIDE (STREET):	15' MIN.
REAR:	15' MIN.
PATIO SETBACKS:	
SIDE:	2' MIN.
REAR:	2' MIN.
FENCE SETBACKS:	
SIDE:	0' MIN.
REAR:	0' MIN.

NOTE
1. TOWNHOME LOTS WILL NOT INCLUDE ACCESSORY STRUCTURES, SHEDS, PERGOLAS, POOLS, SPAS, SCREEN ENCLOSURES, EXPANDED PATIOS, OR GENERATORS.

SITE DATA

GROSS SITE AREA:	21.96 AC. (TO CENTERLINE OF MARGATE BLVD.)
NET (PUD) SITE AREA:	21.30 AC.
SITE PARCEL AREAS:	
FOLIO: 484135050030	GROSS: 21.33 AC.
NET: 20.86 AC.	
FOLIO: 484135080010	GROSS: 0.63 AC.
NET: 0.44 AC.	
TOTAL DWELLING UNITS:	132 - 2 STORY (3 BEDROOM) TOWNHOMES (22' x 95' MIN. LOT SIZE)
TOTAL DENSITY:	6.01 DU / AC. (BASED UPON GROSS SITE AREA)
EXISTING FUTURE LAND USE:	
FOLIO: 484135050030	CITY OF MARGATE: CR - COMMERCIAL RECREATION WITHIN AN IRREGULAR 7.6 RESIDENTIAL DASHED LINE AREA
FOLIO: 484135080010	BROWARD COUNTY: RECREATION & OPEN SPACE WITHIN AN IRREGULAR 7.6 RESIDENTIAL DASHED LINE AREA
FOLIO: 484135050030	CITY OF MARGATE: (R7) - RESIDENTIAL (7) WITHIN AN IRREGULAR 7.6 RESIDENTIAL DASHED LINE AREA
FOLIO: 484135080010	BROWARD COUNTY: IRREGULAR RESIDENTIAL (7.6) WITHIN A DASHED LINE AREA
FOLIO: 484135050030	CITY OF MARGATE: (R7) - RESIDENTIAL (7) WITHIN AN IRREGULAR 8.38 RESIDENTIAL DASHED LINE AREA (20.73 GROSS AC.)
FOLIO: 484135080010	BROWARD COUNTY: IRREGULAR (8.38) RESIDENTIAL WITHIN A DASHED LINE AREA (20.73 GROSS AC.)
FOLIO: 484135050030	CITY OF MARGATE: PARKS WITHIN AN IRREGULAR 8.38 RESIDENTIAL DASHED LINE AREA (0.60 GROSS AC.)
FOLIO: 484135080010	BROWARD COUNTY: RECREATION & OPEN SPACE WITHIN AN IRREGULAR 8.38 RESIDENTIAL DASHED LINE AREA (0.60 GROSS AC.)
FOLIO: 484135080010	CITY OF MARGATE: PARKS WITHIN AN IRREGULAR 8.38 RESIDENTIAL DASHED LINE AREA
FOLIO: 484135080010	BROWARD COUNTY: RECREATION & OPEN SPACE WITHIN AN IRREGULAR 8.38 RESIDENTIAL DASHED LINE AREA
EXISTING ZONING:	FOLIO: 484135050030 S-1 (RECREATIONAL DISTRICT)
	FOLIO: 484135080010 R-3A (MULTIPLE FAMILY DWELLING DISTRICT)
PROPOSED ZONING:	FOLIO: 484135050030 PUD (PLANNED UNIT DEVELOPMENT)
	FOLIO: 484135080010 PUD (PLANNED UNIT DEVELOPMENT)

SITE COVERAGES

NET (PUD) SITE AREA:	21.30 AC.	100%
RESIDENTIAL LOT AREA:	7.38 AC.	34.6%
BLDG. FOOTPRINTS:	3.68 AC.	
DRIVEWAYS:	1.18 AC.	
SIDEWALKS / PATIOS:	0.30 AC.	
PERVIOUS:	2.22 AC.	
PRIVATE ROAD TRACT:	3.44 AC.	16.2%
PAVEMENT:	2.28 AC.	
DRIVEWAYS:	0.30 AC.	
SIDEWALKS:	0.36 AC.	
PERVIOUS:	0.50 AC.	
LAKE #1 SURFACE:	2.78 AC.	13.1%
CANAL SURFACE:	1.01 AC.	4.7%
PRIVATE RECREATION AREA 1:	0.57 AC.	2.7%
CLUBHOUSE:	0.07 AC.	
POOL DECK:	0.08 AC.	
SIDEWALK:	0.02 AC.	
PICKLEBALL COURTS:	0.10 AC.	
PERVIOUS:	0.30 AC.	
PRIVATE RECREATION AREA 2:	0.35 AC.	1.6%
SIDEWALK:	0.01 AC.	
PERVIOUS:	0.34 AC.	
PUBLIC PARK AREA:	1.21 AC.	5.7%
PAVEMENT:	0.07 AC.	
SIDEWALK:	0.06 AC.	
PERVIOUS:	1.08 AC.	
OTHER OPEN SPACE:	4.56 AC.	21.4%
IMPERVIOUS:	0.62 AC.	
PERVIOUS:	3.94 AC.	
TOTAL PERVIOUS:	8.39 AC.	39.4%
TOTAL IMPERVIOUS:	12.91 AC.	60.6%

PROVIDED OPEN SPACE

	PROVIDED	ALLOWED	NOTES
LAKE #1 (SURFACE):	2.78 AC.	1.39 AC.	50% (MAX. PER CODE)
OTHER OPEN SPACE:	3.26 AC.	3.26 AC.	100%
PUBLIC PARK:	1.21 AC.	0.91 AC.	75% (MAX. PER CODE)
PRIVATE RECREATION AREA 1:	0.57 AC.	0.43 AC.	75% (MAX. PER CODE)
PRIVATE RECREATION AREA 2:	0.35 AC.	0.26 AC.	75% (MAX. PER CODE)
FIRE ACCESS (WITHIN 25' SETBACK):	0.36 AC.	0.18 AC.	50% (MAX. PER CODE)
LOT AREA (USEABLE):	1.19 AC.	1.07 AC.	5% (MAX. PER NET SITE)
TOTAL PROVIDED OPEN SPACE:	7.50 AC.	7.50 AC.	35%
TOTAL REQUIRED OPEN SPACE:	7.46 AC.	7.46 AC.	35%

MINIMUM SITE REQUIREMENTS

	REQUIRED	PROVIDED
MAXIMUM BLDG. HEIGHT:	N/A	31 FT 4 IN (2 STORY)
MINIMUM PERIPHERAL SETBACK:	25 FT	25 FT
MINIMUM BUILDING SEPERATION:	N/A	15 FT
MINIMUM FRONT BLDG. SETBACK:	N/A	25 FT (FROM ROAD TRACT)
MINIMUM REAR BLDG. SETBACK:	N/A	40 FT (FROM PROPERTY LINE)

PARKING REQUIREMENTS

	REQUIRED	PROVIDED
132 MULTI-FAMILY D.U. (3 BEDROOM TOWNHOMES)	396 SPACES	396 SPACES
15% SUPPLEMENTAL GUEST PARKING	1 SPACE PER BEDROOM	1 GARAGE & 2 DRIVEWAY SPACES PER UNIT
TOTAL	60 SPACES (396 x 15%)	62 SPACES
TOTAL	456 SPACES	458 SPACES

RECREATION AREA ADA PARKING REQUIREMENTS

	REQUIRED	PROVIDED
ADA PARKING SPACES	1 SPACE	2 SPACES

PUBLIC PARK PARKING

PROVIDED 2 REGULAR PARKING SPACES & 1 ADA SPACE

GENERAL NOTES

- ALL INTERNAL STREETS SHALL BE PRIVATE & MAINTAINED BY H.O.A.
- ALL PROPOSED ELECTRIC AND COMMUNICATION LINES SHALL BE PLACED UNDERGROUND.
- OPEN SPACE, LAKE & 20' LAKE MAINTENANCE EASEMENT SHALL BE MAINTAINED BY H.O.A.
- LAKE IS TO BE USED AS IRRIGATION SOURCE.
- GARBAGE COLLECTION WILL BE CURBSIDE PICKUP.

SCHNARS
ENGINEERING CORPORATION
947 CLINT MOORE ROAD
BOCA RATON, FLORIDA 33487
TEL: (561) 241-1645
FAX: (561) 241-1582

ORIGINAL: OCT. 2022
REVISIONS:
1 1/3/23 CITY COMMENTS
2 2/27/23 CITY COMMENTS
3 8/4/23 CITY COMMENTS
4 10/6/23 CITY COMMENTS
5

PROJECT: NOVE OF MARGATE
TASK: MASTER SITE PLAN
SITE DATA & DETAILS

FLORIDA
MARGATE

Jeffrey T. Schnars, P.E.
Civil Engineer
Florida Registration No. 46697
(FOR THE FIRM)

JOB NO. 17180
DRAWN RAD
DESIGNED JTS
CHECKED JWM
Q.C. JTS
SHEET SP1 OF 6

10/6/2023
7/27/23 JMS

ORIGINAL: OCT. 2022

REVISIONS:	DATE	BY	DESCRIPTION
1	1/3/23	JTS	CITY COMMENTS
2	2/27/23	JTS	CITY COMMENTS
3	8/4/23	JTS	CITY COMMENTS
4	10/6/23	JTS	CITY COMMENTS
5			

TASK:	SITE PLAN
-------	------------------

PROJECT:	NOVE OF MARGATE
STATE:	FLORIDA

SCALE:	
--------	--

JOB NO.	17180
DRAWN	RAD
DESIGNED	JTS
CHECKED	JWM
Q.C.	JTS

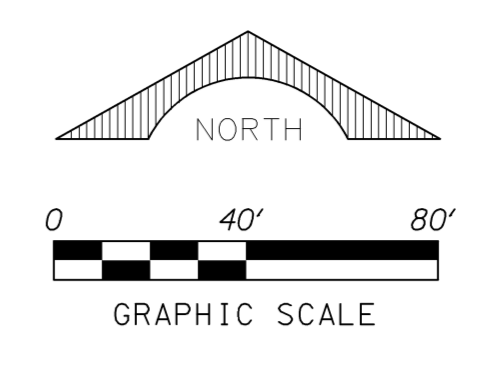

ORIOLE GOLF & TENNIS CLUB

"ORIOLE GOLF AND TENNIS CLUB SECTION ONE"
(P.B. 75, PG. 34, B.C.R.)

ORIOLE MARGATE

BLOCK A
"ORIOLE-MARGATE, SECTION 6"
(P.B. 86, PG. 31, B.C.R.)

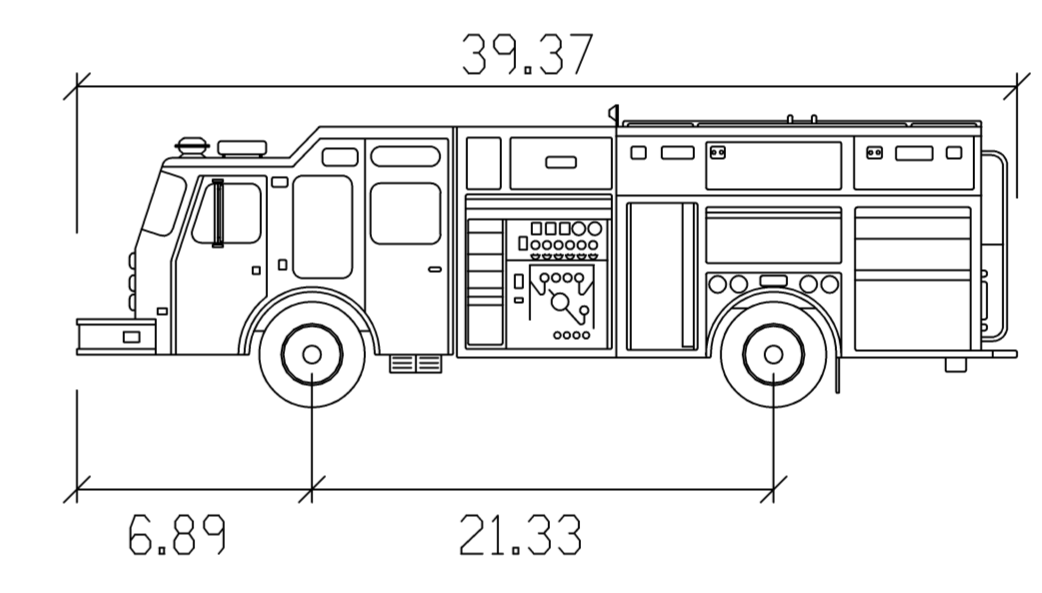
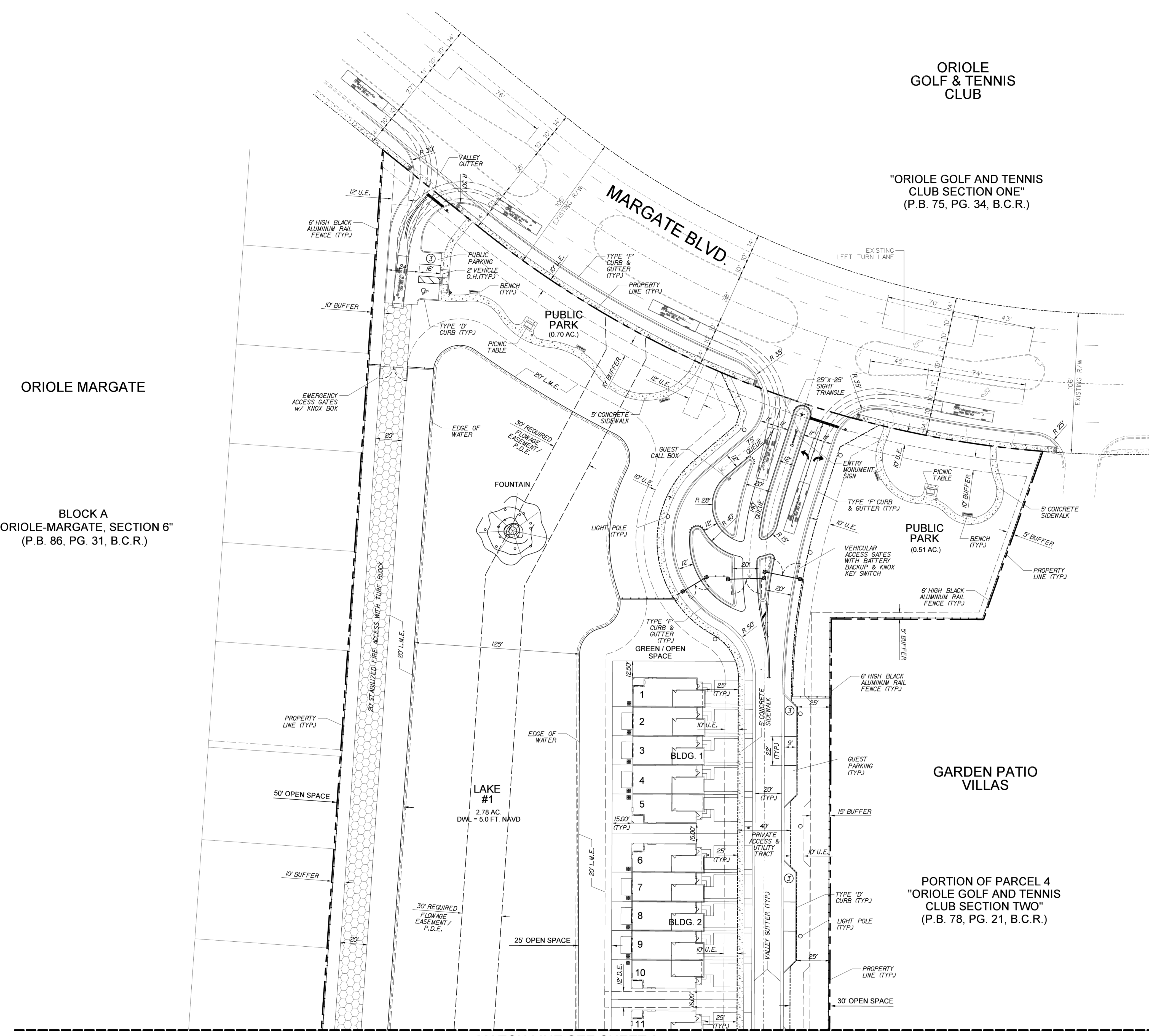

FIRE TRUCK feet

Width	: 8.37
Track	: 7.89
Lock to Lock Time	: 6.0
Steering Angle	: 36.2

FIRE DEPARTMENT NOTES

- PEDESTRIAN GATES TO HAVE A KEY PAD CONTROL FOR RESIDENT ACCESS. GATE TO UNLOCK AUTOMATICALLY DURING MECHANICAL FAILURE TO ALLOW ALL GATES TO MANUALLY OPEN BY PUSHING SWING GATES. DURING POWER FAILURE GATES WILL SWITCH TO BATTERY OPERATED SYSTEM.
- VEHICULAR ACCESS GATES TO BE EQUIPPED WITH KNOX KEY ELECTRONIC SWITCH TO OPEN THE GATE PER CITY FIRE DEPARTMENT REQUIREMENTS. SWITCH IS TO BE MOUNTED ON THE GATE BOX OR ON A SEPERATE PEDESTAL TO MEET FIRE DEPARTMENT REQUIREMENTS. VEHICLE GATES TO UNLOCK AUTOMATICALLY DURING MECHANICAL FAILURE TO ALLOW VEHICLE GATES TO MANUALLY OPEN BY PUSHING SWING GATES. DURING POWER FAILURE GATES WILL SWITCH TO BATTERY OPERATED SYSTEM.

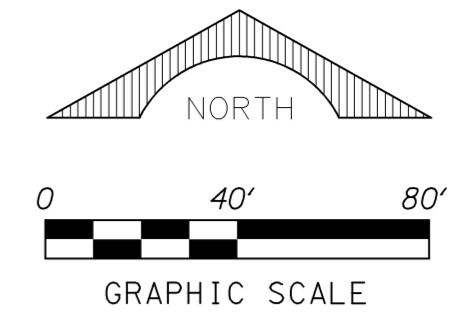

MATCH LINE SEE SHEET 2

BLOCK A
"ORIOLE-MARGATE, SECTION 6"
(P.B. 86, PG. 31, B.C.R.)

GARDEN PATIO
VILLAS

PORTION OF PARCEL 4
"ORIOLE GOLF AND TENNIS
CLUB SECTION TWO"
(P.B. 78, PG. 21, B.C.R.)

ORIOLE MARGATE

PARCEL 2
"ORIOLE GOLF AND TENNIS
CLUB SECTION TWO"
(P.B. 78, PG. 21, B.C.R.)

ORIOLE GARDENS
CONDOMINIUM PH 2

PARCEL 2
"ORIOLE GOLF AND TENNIS
CLUB SECTION TWO"
(P.B. 78, PG. 21, B.C.R.)

PARCEL 6
"ORIOLE GOLF AND TENNIS
CLUB SECTION TWO"
(P.B. 78, PG. 21, B.C.R.)

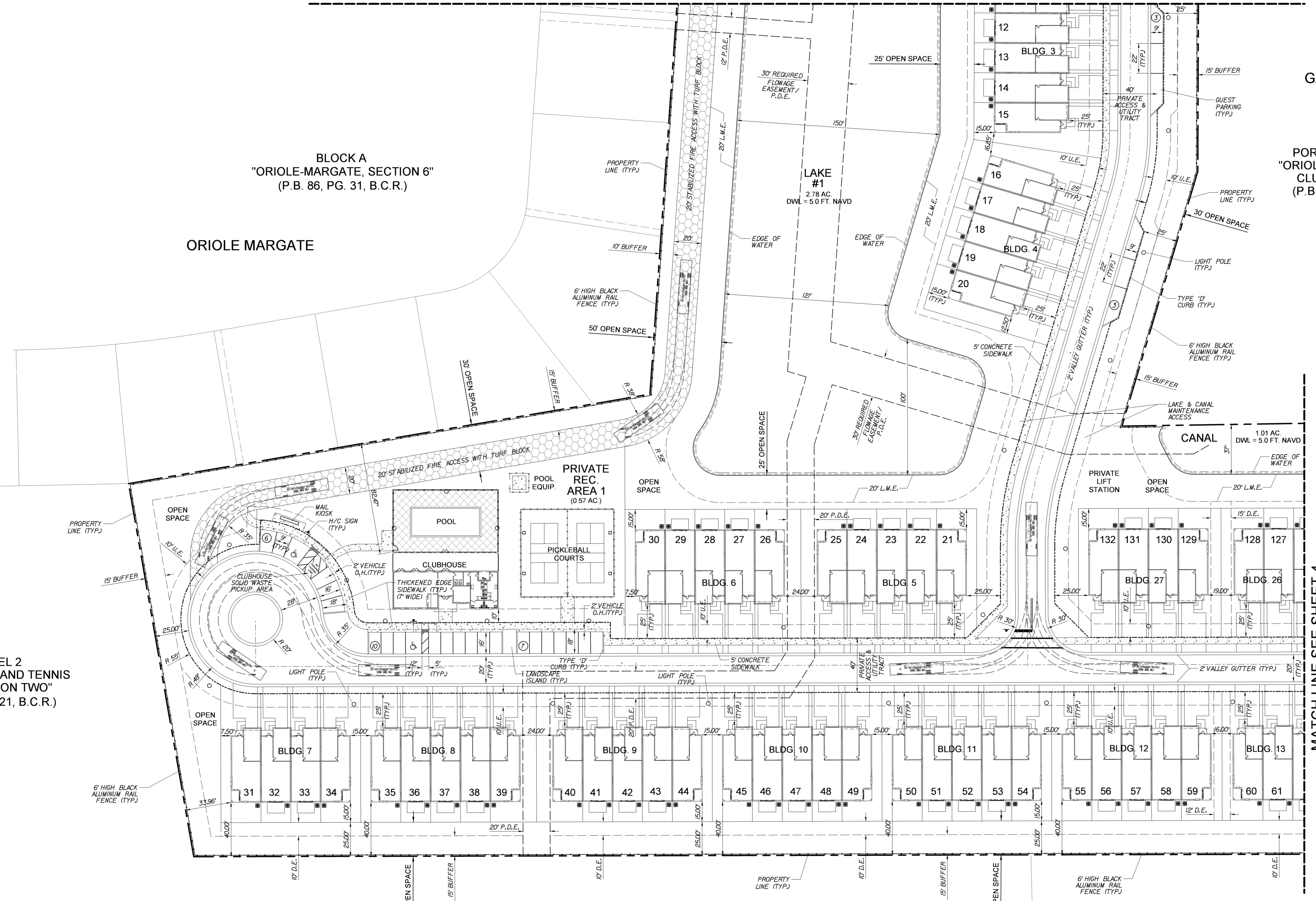

MATCH LINE SEE SHEET 4

ORIGINAL: OCT. 2022

REVISIONS:	DATE	COMMENTS
1	1/3/23	CITY COMMENTS
2	8/4/23	CITY COMMENTS
3	10/6/23	CITY COMMENTS
4		
5		

PROJECT:	TASK:	SITE PLAN
NOVE OF MARGATE		

PROJECT:	TASK:	NOVE OF MARGATE	FLORIDA
MARGATE			

Jeffrey T. Schnars, P.E.
Civil Engineer
Florida Registration No. 46697
(FOR THE FIRM)

JOB NO.	17180
DRAWN	RAD
DESIGNED	JTS
CHECKED	JWM
Q.C.	JTS

GARDEN PATIO VILLAS

PORTION OF PARCEL 4
"ORIOLE GOLF AND TENNIS CLUB SECTION TWO"
(P.B. 78, PG. 21, B.C.R.)

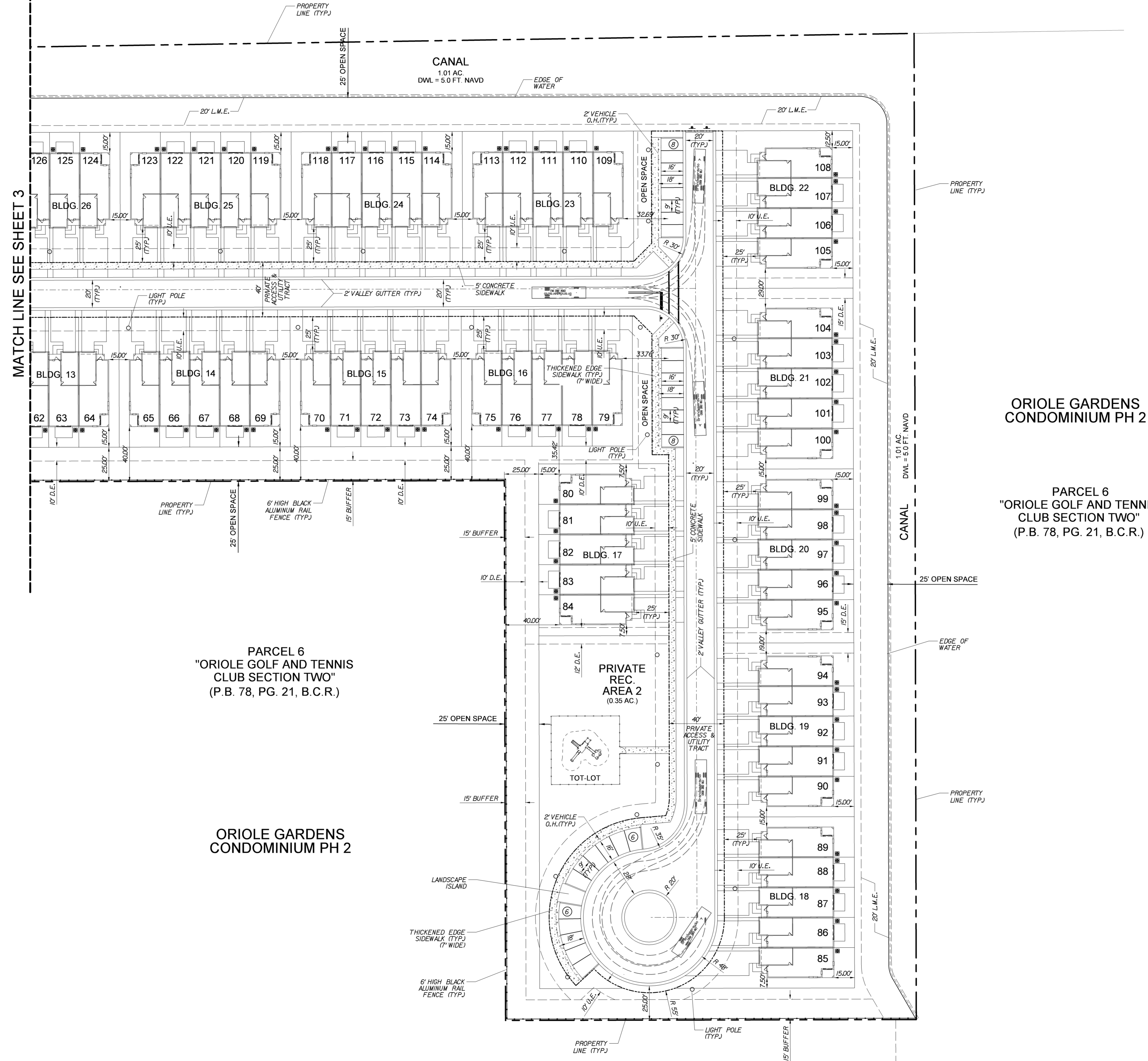
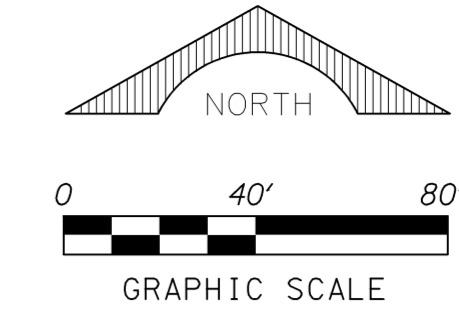

MATCH LINE SEE SHEET 3

ORIOLE GARDENS CONDOMINIUM PH 2

PARCEL 6
"ORIOLE GOLF AND TENNIS CLUB SECTION TWO"
(P.B. 78, PG. 21, B.C.R.)

PARCEL 6
"ORIOLE GOLF AND TENNIS CLUB SECTION TWO"
(P.B. 78, PG. 21, B.C.R.)

ORIOLE GARDENS CONDOMINIUM PH 2

SCHNARS
ENGINEERING CORPORATION
947 CLINT MOORE ROAD
BOCA RATON, FLORIDA 33487
TEL: (561) 241-1465
FAX: (561) 241-1582
CERTIFICATE OF AUTHORIZATION No. 6640

ORIGINAL:	OCT. 2022
REVISIONS:	
1	1/3/23 CITY COMMENTS
2	8/4/23 CITY COMMENTS
3	10/6/23 CITY COMMENTS
4	
5	

PROJECT:	NOVE OF MARGATE
TASK:	SITE PLAN
STATE:	FLORIDA

PROJECT:	MARGATE
TASK:	NOVE OF MARGATE
STATE:	FLORIDA

Jeffrey T. Schnars, P.E.
Civil Engineer
Florida Registration No. 46697
(FOR THE FIRM)

JOB NO.	17180
DRAWN	RAD
DESIGNED	JTS
CHECKED	JWM
Q.C.	JTS

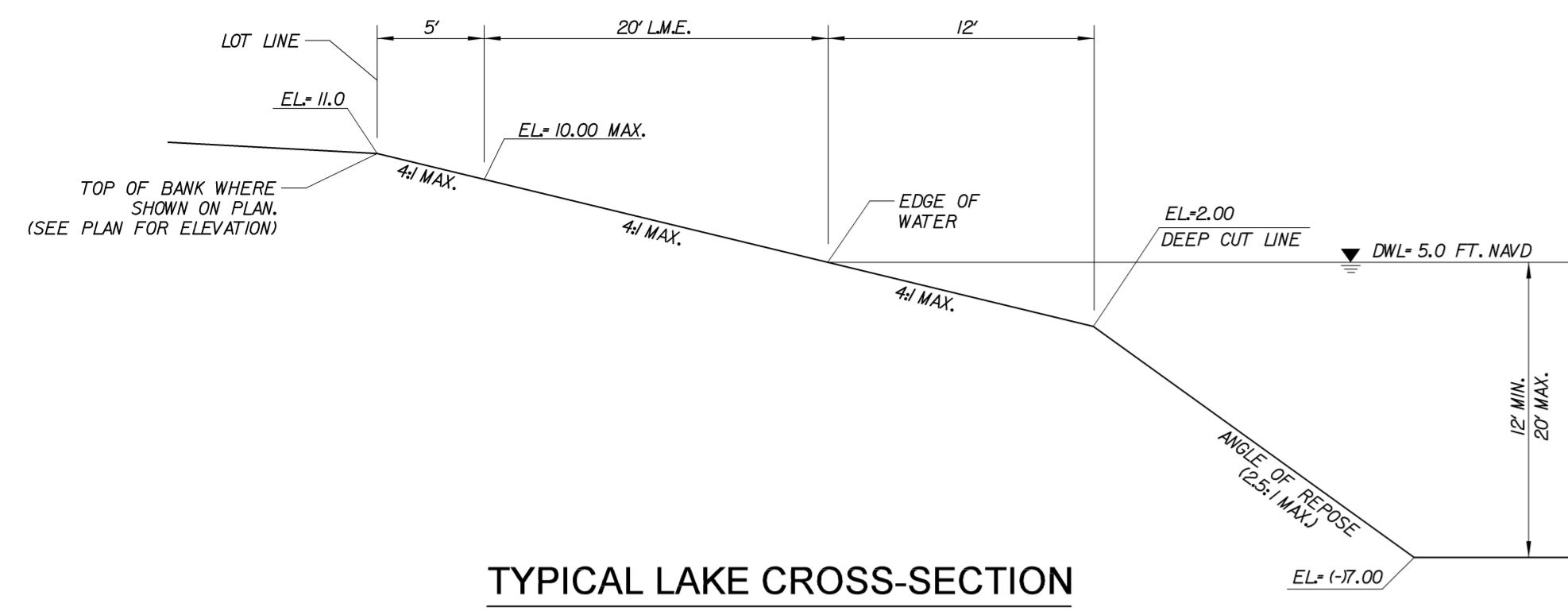

TYPICAL LAKE CROSS-SECTION

N.T.S.

NOTE:

ALL ELEVATIONS ARE BASED UPON THE NORTH AMERICAN VERTICAL DATUM (NAVD) OF 1988.

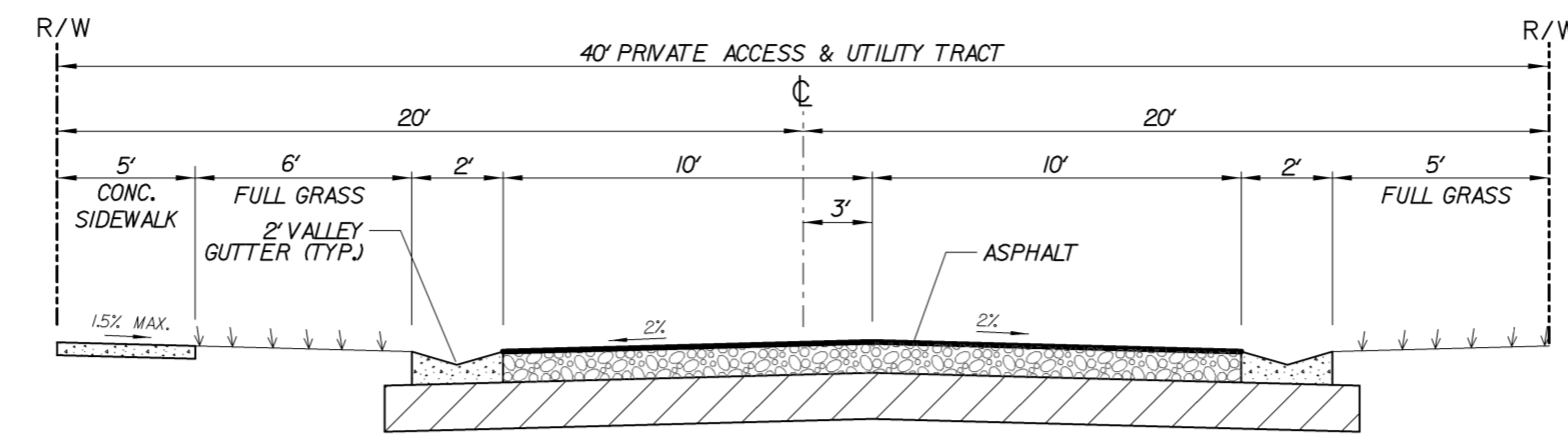

TYPICAL ROAD SECTION

40' PRIVATE ROAD TRACT
N.T.S.

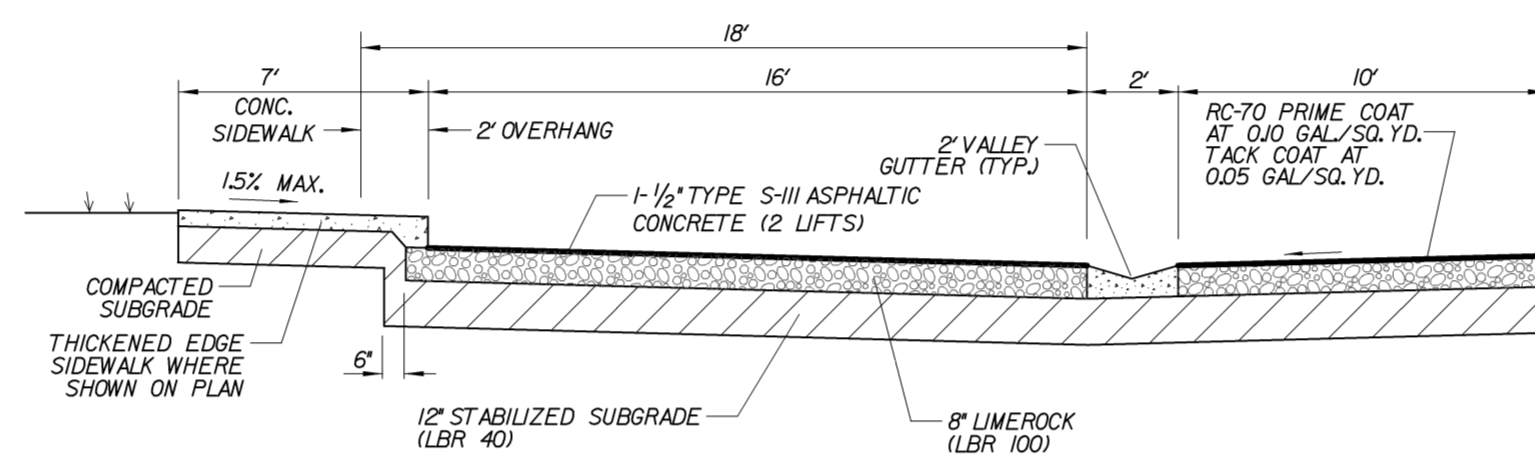

TYPICAL PARKING WITH SIDEWALK DETAIL

N.T.S.

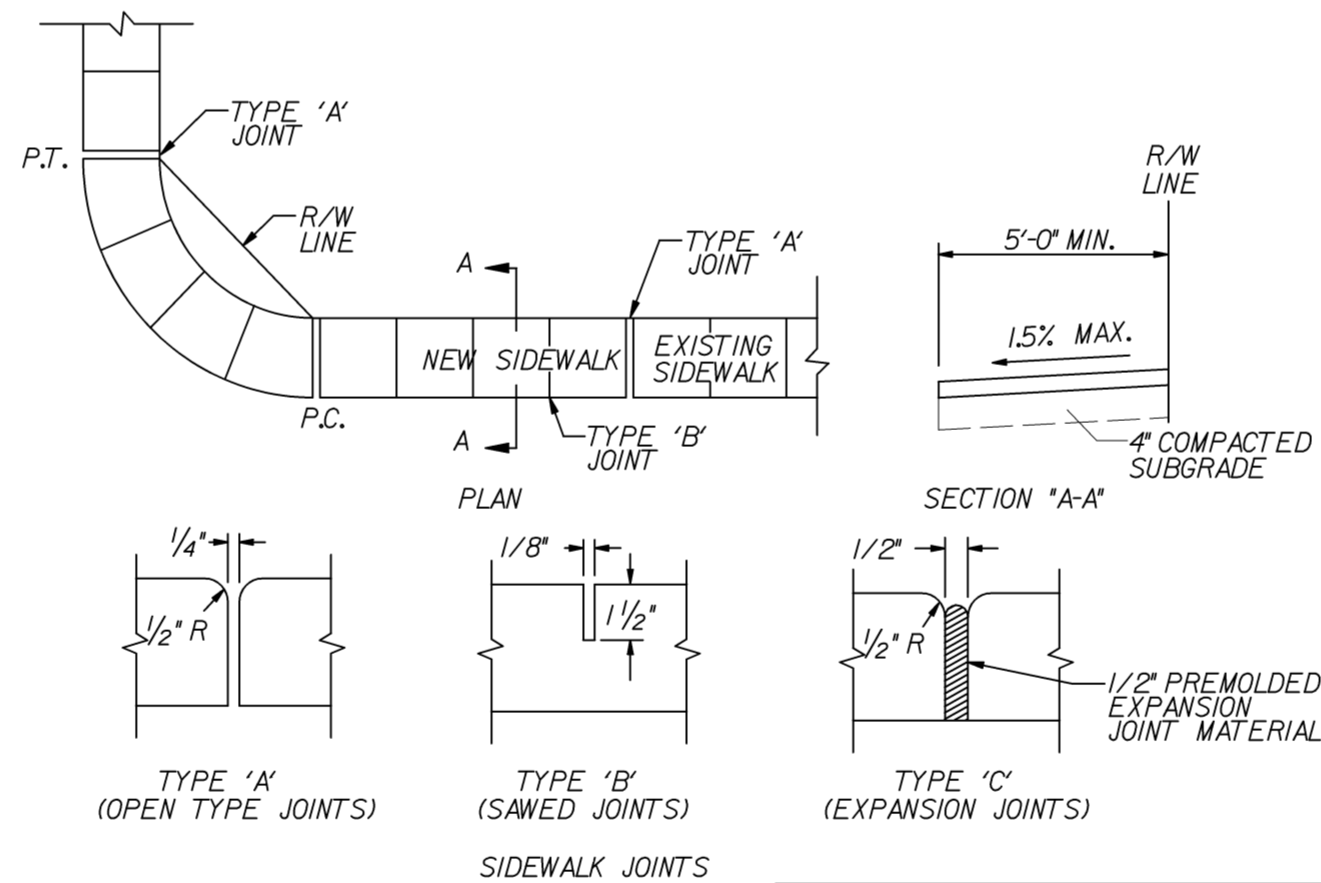

TABLE OF SIDEWALK THICKNESS - "T"	
LOCATION	"T"
RESIDENTIAL AREAS & CART PATHS	4"
AT DRIVEWAYS AND OTHER AREAS	6"

TABLE OF SIDEWALK JOINTS	
TYPE	LOCATION
'A'	P.C. AND P.T. OF CURVES, JUNCTION OF EXISTING AND NEW SIDEWALKS
'B'	5'-0" CENTER TO CENTER ON SIDEWALKS
'C'	*WHERE SIDEWALK ABUTS CONCRETE CURBS, DRIVEWAYS, AND SIMILAR STRUCTURES

NOTES:

- SUBGRADE TO BE A MINIMUM 4" OF CLEAN SAND OR SANDY LOAM COMPACTED TO 95% DENSITY AASHTO T-99.
- SIDEWALKS TO BE PORTLAND CEMENT CONCRETE, MIN. 2500 PSI @ 28 DAYS.
- AT DRIVEWAY LOCATIONS, SIDEWALKS SHALL BE 6" THICK AND SHALL INCLUDE 6X6 W1.4XW1.4 WELDED WIDE MESH WITH 2" OR LOWER FROM THE BOTTOM AND END.
- SIDEWALK SLOPES SHALL MEET THE REQUIREMENTS OF THE AMERICANS WITH DISABILITIES ACT. SIDEWALKS SHALL HAVE A MAXIMUM TRANSVERSE SLOPE OF 0.02 FEET PER FOOT, AND A MINIMUM TRANSVERSE SLOPE OF 0.01 FEET PER FOOT TOWARD THE SWALE OR GUTTER AND SHALL BE GIVEN A TRANSVERSE HAIR BROOM FINISH.
- RAMPS SHALL BE PROVIDED AT ALL INTERSECTIONS IN ACCORDANCE WITH FDOT INDEX 522-002.

SIDEWALK DETAIL

N.T.S.

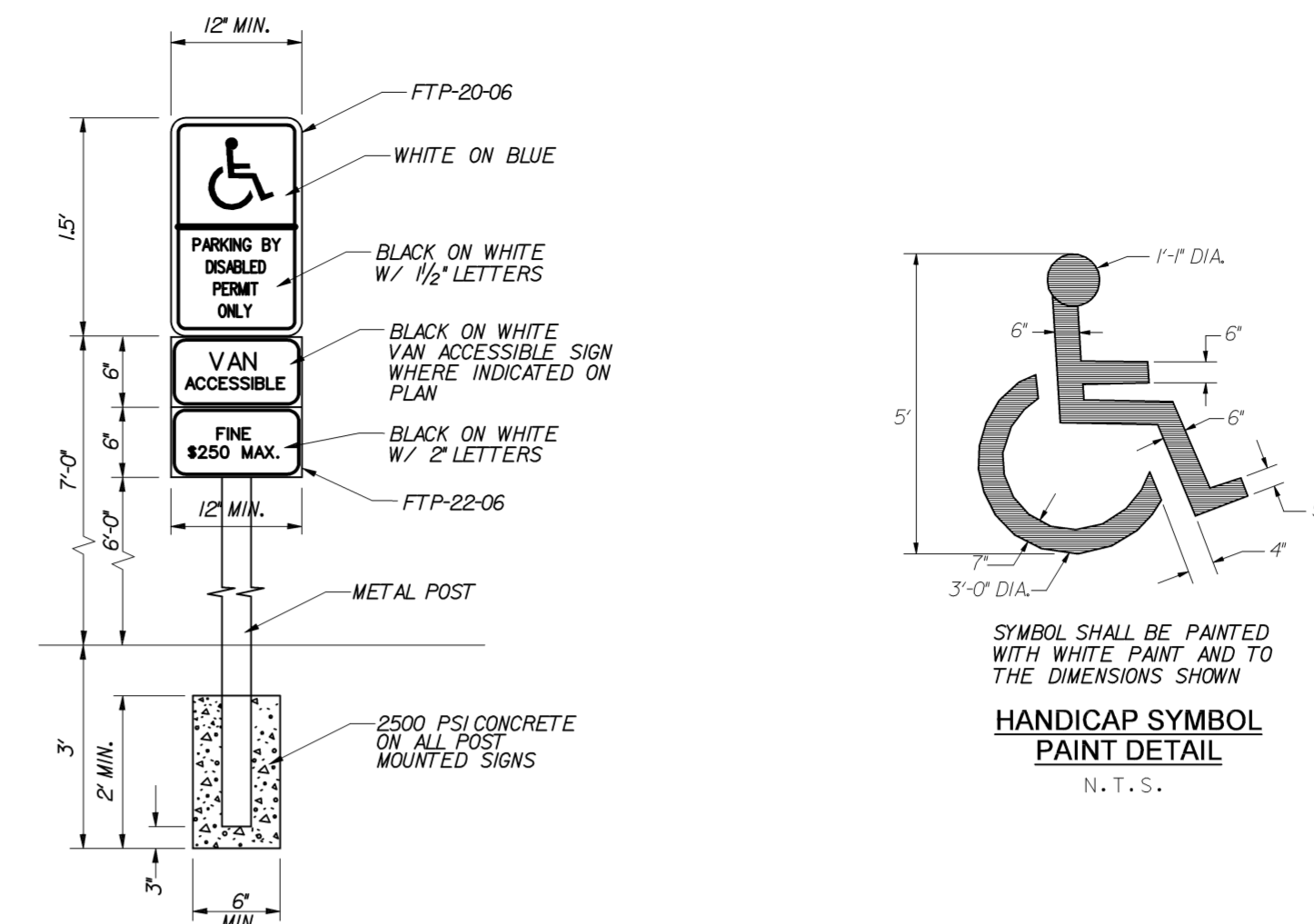

HANDICAP PARKING SIGN

N.T.S.

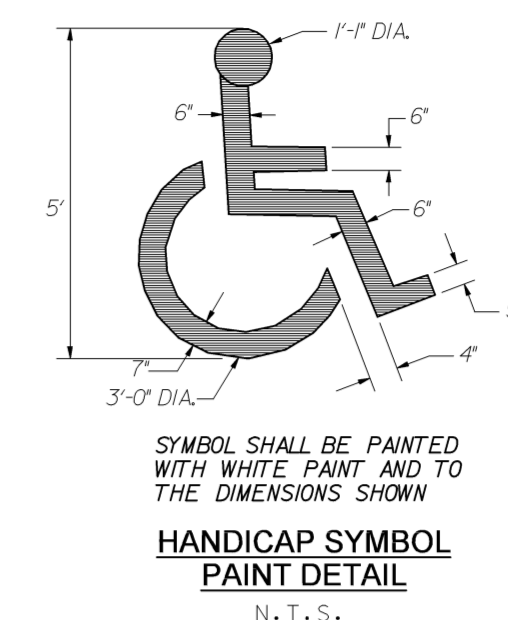

HANDICAP SYMBOL PAINT DETAIL

N.T.S.

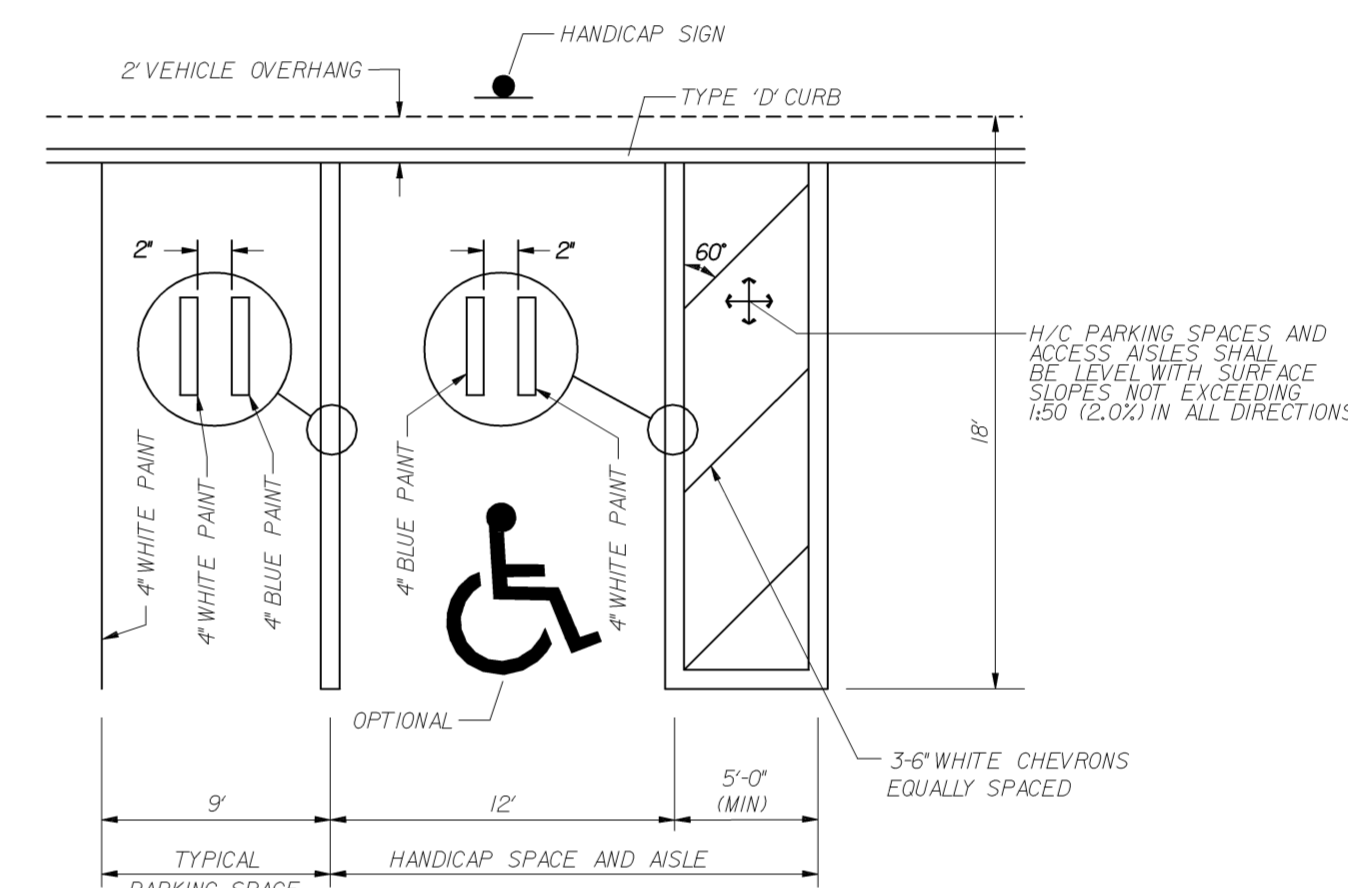

TYPICAL PARKING DETAILS

N.T.S.

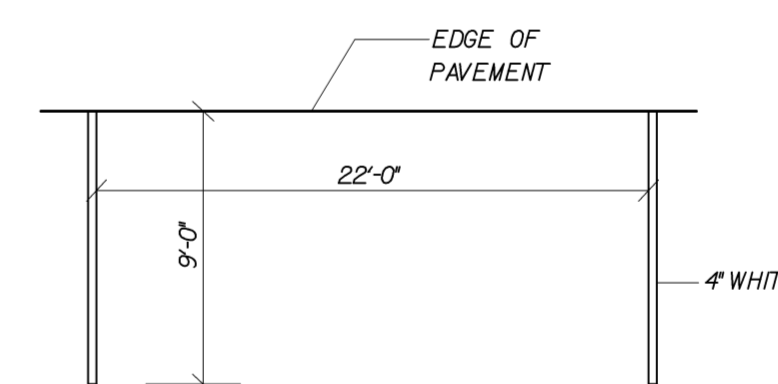

PARALLEL PARKING SPACE

N.T.S.

ORIGINAL: OCT. 2022

REVISIONS:

- | NO. | DATE | DESCRIPTION |
|-----|---------|---------------|
| 1 | 1/3/23 | CITY COMMENTS |
| 2 | 8/4/23 | CITY COMMENTS |
| 3 | 10/6/23 | CITY COMMENTS |
| 4 | | |
| 5 | | |

TASK: **SITE PLAN DETAILS**

PROJECT: **NOVE OF MARGATE**

STATE: **FLORIDA**

SEAL

Jeffrey T. Schnars, P.E.
Civil Engineer
Florida Registration No. 46697
(FOR THE FIRM)

JOB NO. 17180
DRAWN RAD
DESIGNED JTS
CHECKED JWM
Q.C. JTS

SHEET SP5 OF 6

7/28/24 AM FILED

SCHNARS
ENGINEERING CORPORATION
947 CLINT MOORE ROAD
BOCA RATON, FLORIDA 33487
TEL: (561) 241-1465
FAX: (561) 241-1582
CERTIFICATE OF AUTHORIZATION No. 6640

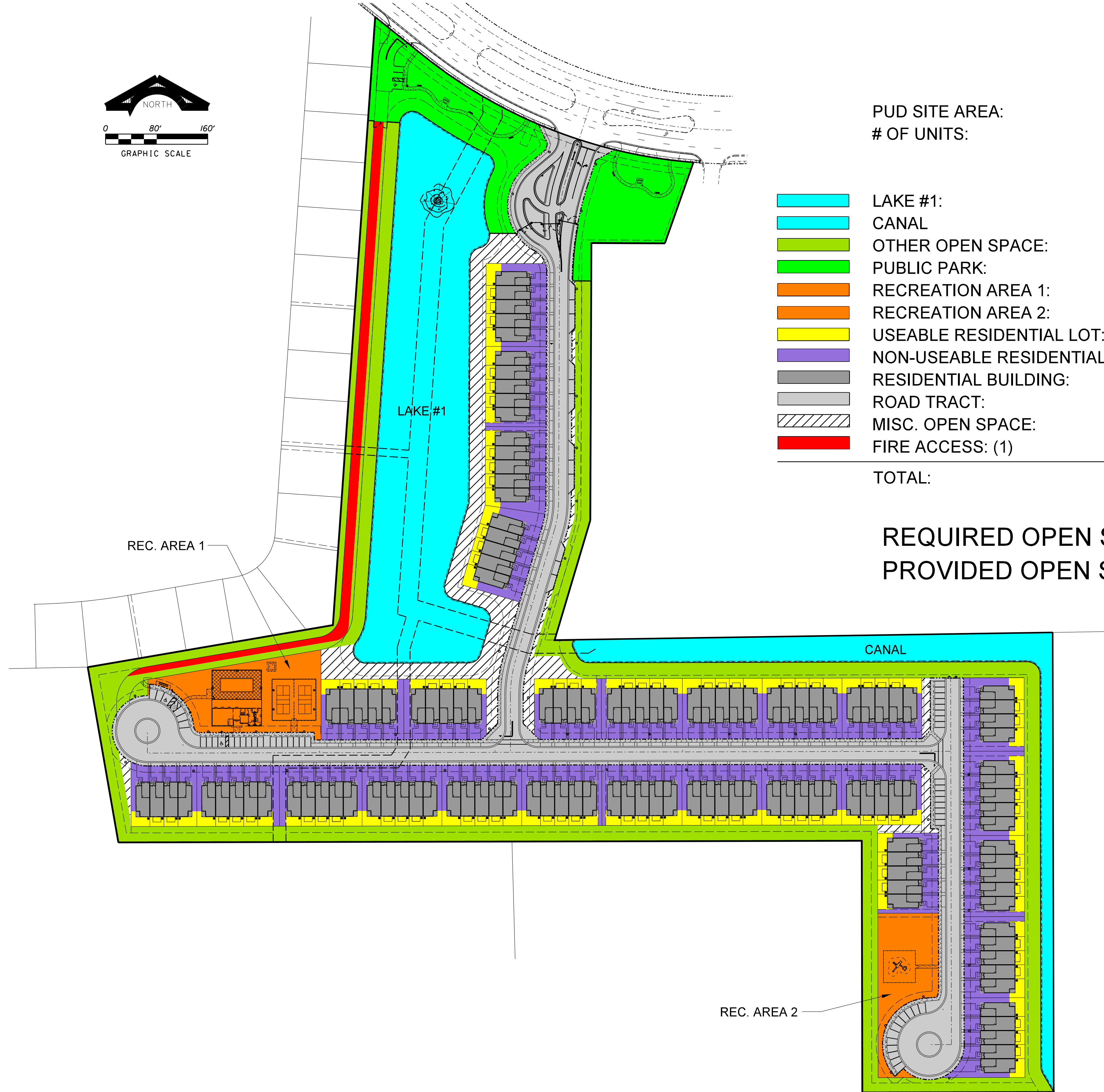
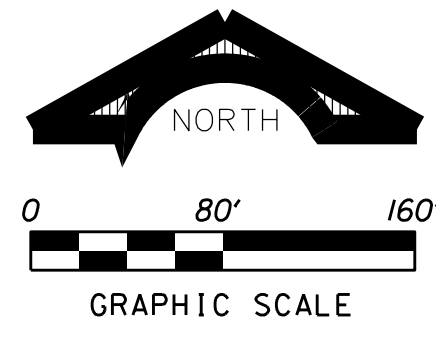

PUD SITE AREA: 21.302 AC.
 # OF UNITS: 132 DU

			PERCENT ALLOWED
LAKE #1:	2.777 AC.	1.389 AC.	50% (MAX. PER CODE)
CANAL	1.006 AC.	EXCLUDED	0%
OTHER OPEN SPACE:	3.260 AC.	3.260 AC.	100%
PUBLIC PARK:	1.208 AC.	0.906 AC.	75% (MAX. PER CODE)
RECREATION AREA 1:	0.566 AC.	0.425 AC.	75% (MAX. PER CODE)
RECREATION AREA 2:	0.349 AC.	0.262 AC.	75% (MAX. PER CODE)
USEABLE RESIDENTIAL LOT:	1.189 AC.	1.065 AC.	5% (MAX. PER PUD AREA)
NON-USEABLE RESIDENTIAL LOT:	2.522 AC.	EXCLUDED	0%
RESIDENTIAL BUILDING:	3.667 AC.	EXCLUDED	0%
ROAD TRACT:	3.443 AC.	EXCLUDED	0%
MISC. OPEN SPACE:	0.958 AC.	EXCLUDED	0%
FIRE ACCESS: (1)	0.357 AC.	0.179 AC.	50%
TOTAL:	21.302 AC.	7.486 AC.	

REQUIRED OPEN SPACE: 7.455 AC. 35.0%
 PROVIDED OPEN SPACE: 7.486 AC. 35.1%

NOTES:
 (1) WITHIN 25 FT. PERIPHERAL SETBACK.

ORIGINAL: OCT. 2022

REVISIONS:	
1	9/22/23 CITY COMMENTS
2	9/25/23 CITY COMMENTS
3	10/6/23 CITY COMMENTS
4	
5	

TASK:	OPEN SPACE EXHIBIT
PROJECT:	NOVE OF MARGATE
STATE:	FLORIDA
CITY:	MARGATE

PROJECT:	NOVE OF MARGATE
STATE:	FLORIDA
CITY:	MARGATE

APPENDIX B

Traffic Counts and Signal Timing

Traf Tech Engineering Inc.

File Name : 10-SW 71st Ave & Southgate Blvd
 Site Code : 00000000
 Start Date : 5/11/2022
 Page No : 1

Groups Printed- Peds & Bikes

Start Time	SW 71st Ave From North				Southgate Blvd From East				SW 71st Ave From South				Southgate Blvd From West				Int. Total	
	Bikes			Peds	Bikes			Peds	Bikes			Peds	Bikes			Peds		
07:00	0	0	0	0	0	0	0	0	0	0	0	0	1	0	0	0	0	1
07:15	0	0	0	1	0	0	0	2	0	0	0	2	0	0	0	0	0	5
07:30	0	0	0	0	0	0	0	0	0	0	0	1	0	0	0	0	0	1
*** BREAK ***																		
Total	0	0	0	1	0	0	0	2	0	0	0	4	0	0	0	0	0	7
08:00	0	0	0	0	0	0	0	0	0	0	0	2	0	0	0	0	0	2
*** BREAK ***																		
08:45	0	0	0	0	0	0	0	0	0	0	0	1	0	0	0	0	0	1
Total	0	0	0	0	0	0	0	0	0	0	0	3	0	0	0	0	0	3
*** BREAK ***																		
16:00	0	0	0	0	0	0	0	0	0	0	0	2	0	0	0	0	0	2
16:15	0	0	0	0	0	0	0	0	0	0	0	2	0	0	0	0	0	2
*** BREAK ***																		
16:45	0	0	0	0	0	0	0	0	0	0	0	1	0	0	0	0	0	1
Total	0	0	0	0	0	0	0	0	0	0	0	5	0	0	0	0	0	5
*** BREAK ***																		
17:45	0	0	0	0	0	0	0	0	0	0	0	2	0	0	0	0	0	2
Total	0	0	0	0	0	0	0	0	0	0	0	2	0	0	0	0	0	2
Grand Total	0	0	0	1	0	0	0	2	0	0	0	14	0	0	0	0	0	17
Apprch %	0	0	0	100	0	0	0	100	0	0	0	100	0	0	0	0	0	
Total %	0	0	0	5.9	0	0	0	11.8	0	0	0	82.4	0	0	0	0	0	

Traf Tech Engineering Inc.

File Name : 10-SW 71st Ave & Southgate Blvd
 Site Code : 00000000
 Start Date : 5/11/2022
 Page No : 1

Groups Printed- Autos - Heavy Vehicles

Start Time	SW 71st Ave From North					Southgate Blvd From East					SW 71st Ave From South					Southgate Blvd From West					Int. Total
	Right	Thru	Left	U-Turns	App. Total	Right	Thru	Left	U-Turns	App. Total	Right	Thru	Left	U-Turns	App. Total	Right	Thru	Left	U-Turns	App. Total	
07:00	76	190	36	0	302	50	96	17	0	163	1	174	32	0	207	36	134	108	0	278	950
07:15	89	199	56	0	344	92	113	7	0	212	26	233	42	0	301	37	157	103	0	297	1154
07:30	86	170	81	0	337	78	132	8	0	218	17	190	34	0	241	38	203	148	0	389	1185
07:45	116	218	78	0	412	49	90	10	0	149	24	222	40	0	286	37	148	124	0	309	1156
Total	367	777	251	0	1395	269	431	42	0	742	68	819	148	0	1035	148	642	483	0	1273	4445
08:00	104	189	41	1	335	43	100	9	0	152	34	219	36	0	289	38	140	123	0	301	1077
08:15	92	182	40	1	315	56	103	11	0	170	28	157	19	0	204	40	136	96	0	272	961
08:30	86	206	54	1	347	57	86	6	0	149	39	182	30	0	251	29	132	120	0	281	1028
08:45	103	166	43	0	312	33	74	8	0	115	23	197	30	0	250	19	110	89	0	218	895
Total	385	743	178	3	1309	189	363	34	0	586	124	755	115	0	994	126	518	428	0	1072	3961
*** BREAK ***																					
16:00	128	201	57	1	387	49	120	23	0	192	32	171	32	1	236	33	83	103	0	219	1034
16:15	131	244	43	0	418	26	90	30	0	146	29	187	23	0	239	36	107	101	0	244	1047
16:30	116	234	48	0	398	39	74	27	0	140	28	217	45	1	291	46	80	89	0	215	1044
16:45	105	195	31	0	331	48	113	19	0	180	17	173	52	2	244	40	91	101	0	232	987
Total	480	874	179	1	1534	162	397	99	0	658	106	748	152	4	1010	155	361	394	0	910	4112
17:00	126	257	37	0	420	61	108	18	0	187	20	236	39	0	295	47	100	91	0	238	1140
17:15	109	235	45	0	389	47	155	21	0	223	25	206	57	0	288	32	108	81	0	221	1121
17:30	143	234	48	4	429	44	143	33	0	220	28	197	36	1	262	52	106	91	0	249	1160
17:45	110	223	30	0	363	42	107	26	0	175	24	203	57	2	286	28	91	80	0	199	1023
Total	488	949	160	4	1601	194	513	98	0	805	97	842	189	3	1131	159	405	343	0	907	4444
Grand Total	1720	3343	768	8	5839	814	1704	273	0	2791	395	3164	604	7	4170	588	1926	1648	0	4162	16962
Apprch %	29.5	57.3	13.2	0.1		29.2	61.1	9.8	0		9.5	75.9	14.5	0.2		14.1	46.3	39.6	0		
Total %	10.1	19.7	4.5	0	34.4	4.8	10	1.6	0	16.5	2.3	18.7	3.6	0	24.6	3.5	11.4	9.7	0	24.5	
Autos	1707	3320					1695					3143				1911	1624				16813
% Autos	99.2	99.3	98.7	100	99.2	99.4	99.5	98.5	0	99.4	99.2	99.3	98.5	100	99.2	97.8	99.2	98.5	0	98.8	99.1
Heavy Vehicles																					
% Heavy Vehicles	0.8	0.7	1.3	0	0.8	0.6	0.5	1.5	0	0.6	0.8	0.7	1.5	0	0.8	2.2	0.8	1.5	0	1.2	0.9

Traf Tech Engineering Inc.

File Name : 10-SW 71st Ave & Southgate Blvd

Site Code : 00000000

Start Date : 5/11/2022

Page No : 2

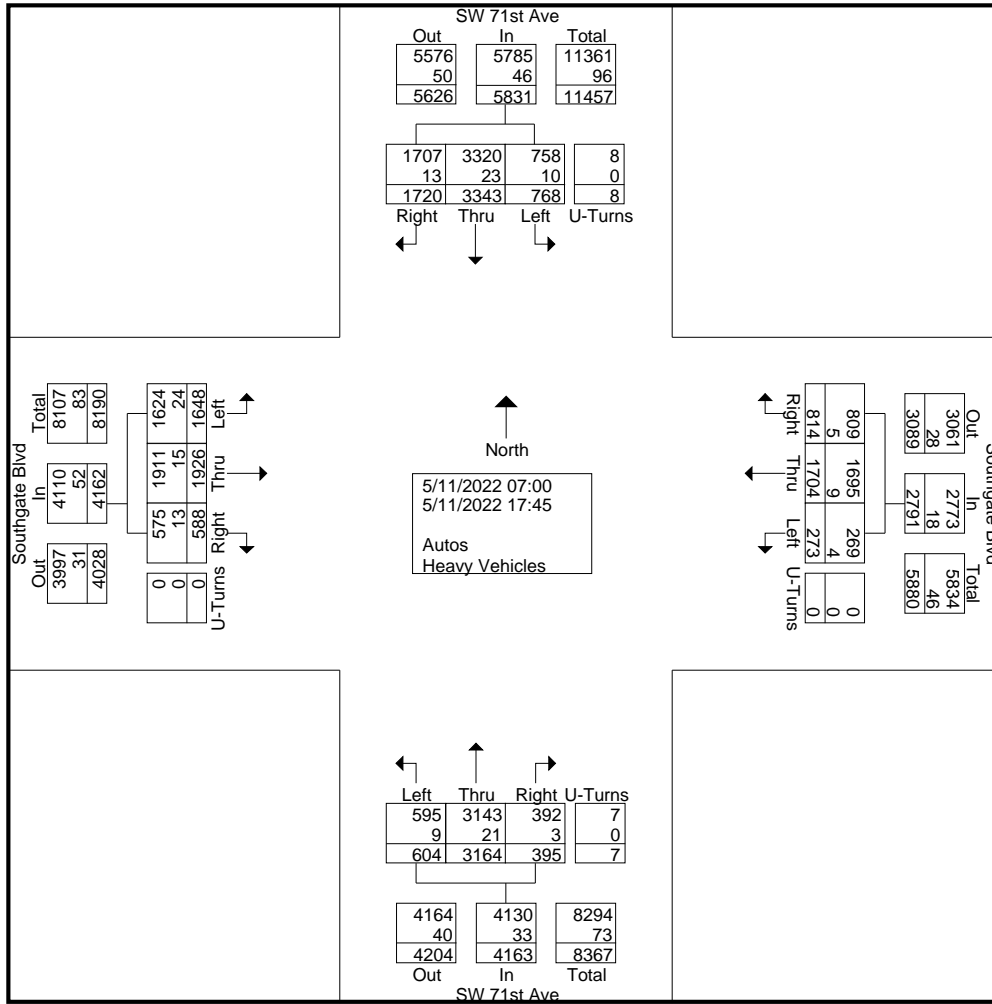

Traf Tech Engineering Inc.

File Name : 10-SW 71st Ave & Southgate Blvd

Site Code : 00000000

Start Date : 5/11/2022

Page No : 3

Start Time	SW 71st Ave From North					Southgate Blvd From East					SW 71st Ave From South					Southgate Blvd From West					Int. Total
	Right	Thru	Left	U-Turns	App. Total	Right	Thru	Left	U-Turns	App. Total	Right	Thru	Left	U-Turns	App. Total	Right	Thru	Left	U-Turns	App. Total	
Peak Hour Analysis From 07:00 to 17:45 - Peak 1 of 1																					
Peak Hour for Entire Intersection Begins at 07:15																					
07:15	89	199	56	0	344	92	113	7	0	212	26	233	42	0	301	37	157	103	0	297	1154
07:30	86	170	81	0	337	78	132	8	0	218	17	190	34	0	241	38	203	148	0	389	1185
07:45	116	218	78	0	412	49	90	10	0	149	24	222	40	0	286	37	148	124	0	309	1156
08:00	104	189	41	1	335	43	100	9	0	152	34	219	36	0	289	38	140	123	0	301	1077
Total Volume	395	776	256	1	1428	262	435	34	0	731	101	864	152	0	1117	150	648	498	0	1296	4572
% App. Total	27.7	54.3	17.9	0.1		35.8	59.5	4.7	0		9	77.4	13.6	0		11.6	50	38.4	0		
PHF	.851	.890	.790	.250	.867	.712	.824	.850	.000	.838	.743	.927	.905	.000	.928	.987	.798	.841	.000	.833	.965
Autos	393	771	254	1	1419	260	433	33	0	726	100	858	149	0	1107	147	645	493	0	1285	4537
% Autos	99.5	99.4	99.2	100	99.4	99.2	99.5	97.1	0	99.3	99.0	99.3	98.0	0	99.1	98.0	99.5	99.0	0	99.2	99.2
Heavy Vehicles																					
% Heavy Vehicles	0.5	0.6	0.8	0	0.6	0.8	0.5	2.9	0	0.7	1.0	0.7	2.0	0	0.9	2.0	0.5	1.0	0	0.8	0.8

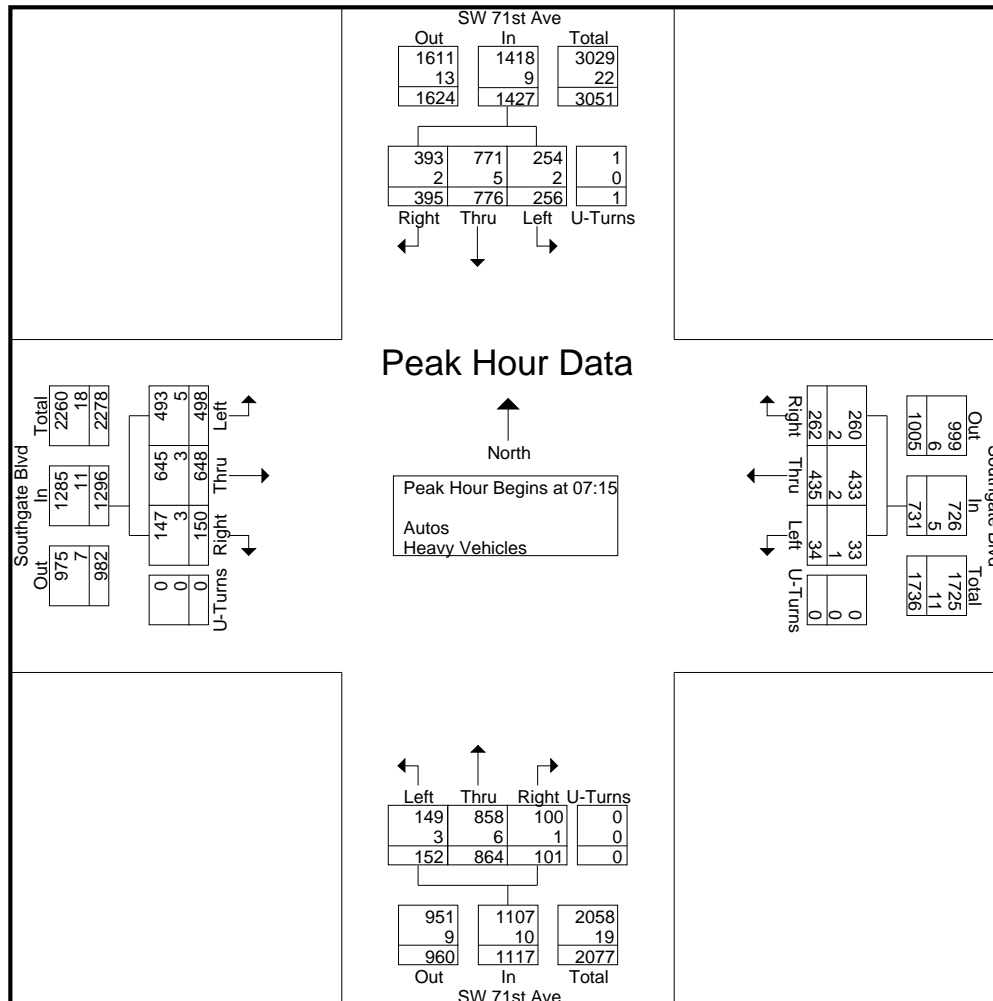

Traf Tech Engineering Inc.

File Name : 10-SW 71st Ave & Southgate Blvd

Site Code : 00000000

Start Date : 5/11/2022

Page No : 4

Start Time	SW 71st Ave From North					Southgate Blvd From East					SW 71st Ave From South					Southgate Blvd From West					Int. Total
	Right	Thru	Left	U-Turns	App. Total	Right	Thru	Left	U-Turns	App. Total	Right	Thru	Left	U-Turns	App. Total	Right	Thru	Left	U-Turns	App. Total	
Peak Hour Analysis From 07:00 to 08:45 - Peak 1 of 1																					
Peak Hour for Entire Intersection Begins at 07:15																					
07:15	89	199	56	0	344	92	113	7	0	212	26	233	42	0	301	37	157	103	0	297	1154
07:30	86	170	81	0	337	78	132	8	0	218	17	190	34	0	241	38	203	148	0	389	1185
07:45	116	218	78	0	412	49	90	10	0	149	24	222	40	0	286	37	148	124	0	309	1156
08:00	104	189	41	1	335	43	100	9	0	152	34	219	36	0	289	38	140	123	0	301	1077
Total Volume	395	776	256	1	1428	262	435	34	0	731	101	864	152	0	1117	150	648	498	0	1296	4572
% App. Total	27.7	54.3	17.9	0.1		35.8	59.5	4.7	0		9	77.4	13.6	0		11.6	50	38.4	0		
PHF	.851	.890	.790	.250	.867	.712	.824	.850	.000	.838	.743	.927	.905	.000	.928	.987	.798	.841	.000	.833	.965
Autos	393	771	254	1	1419	260	433	33	0	726	100	858	149	0	1107	147	645	493	0	1285	4537
% Autos	99.5	99.4	99.2	100	99.4	99.2	99.5	97.1	0	99.3	99.0	99.3	98.0	0	99.1	98.0	99.5	99.0	0	99.2	99.2
Heavy Vehicles																					
% Heavy Vehicles	0.5	0.6	0.8	0	0.6	0.8	0.5	2.9	0	0.7	1.0	0.7	2.0	0	0.9	2.0	0.5	1.0	0	0.8	0.8

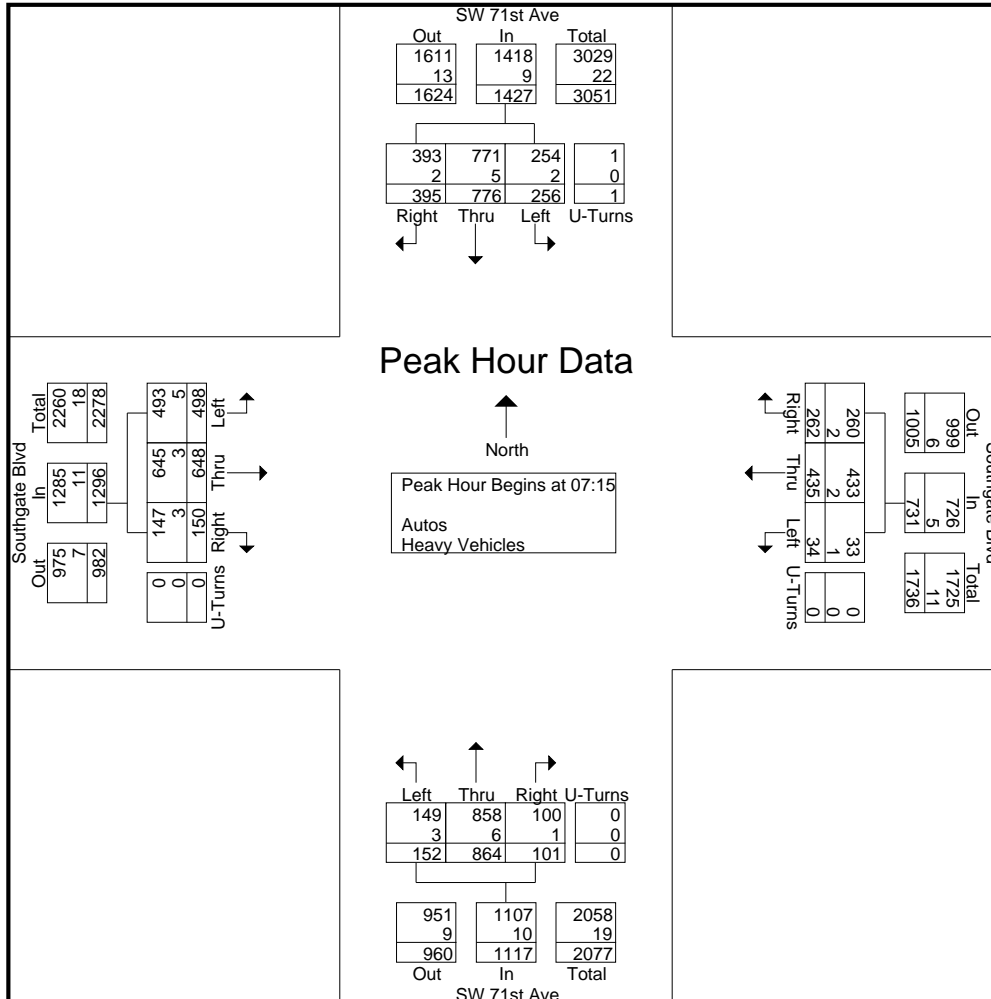

Traf Tech Engineering Inc.

File Name : 10-SW 71st Ave & Southgate Blvd
 Site Code : 00000000
 Start Date : 5/11/2022
 Page No : 5

Start Time	SW 71st Ave From North					Southgate Blvd From East					SW 71st Ave From South					Southgate Blvd From West					Int. Total
	Right	Thru	Left	U-Turns	App. Total	Right	Thru	Left	U-Turns	App. Total	Right	Thru	Left	U-Turns	App. Total	Right	Thru	Left	U-Turns	App. Total	
Peak Hour Analysis From 16:00 to 17:45 - Peak 1 of 1																					
Peak Hour for Entire Intersection Begins at 17:00																					
17:00	126	257	37	0	420	61	108	18	0	187	20	236	39	0	295	47	100	91	0	238	1140
17:15	109	235	45	0	389	47	155	21	0	223	25	206	57	0	288	32	108	81	0	221	1121
17:30	143	234	48	4	429	44	143	33	0	220	28	197	36	1	262	52	106	91	0	249	1160
17:45	110	223	30	0	363	42	107	26	0	175	24	203	57	2	286	28	91	80	0	199	1023
Total Volume	488	949	160	4	1601	194	513	98	0	805	97	842	189	3	1131	159	405	343	0	907	4444
% App. Total	30.5	59.3	10	0.2		24.1	63.7	12.2	0		8.6	74.4	16.7	0.3		17.5	44.7	37.8	0		
PHF	.853	.923	.833	.250	.933	.795	.827	.742	.000	.902	.866	.892	.829	.375	.958	.764	.938	.942	.000	.911	.958
Autos	487	941	159	4	1591	194	511	97	0	802	97	838	187	3	1125	156	400	334	0	890	4408
% Autos	99.8	99.2	99.4	100	99.4	100	99.6	99.0	0	99.6	100	99.5	98.9	100	99.5	98.1	98.8	97.4	0	98.1	99.2
Heavy Vehicles																					
% Heavy Vehicles	0.2	0.8	0.6	0	0.6	0	0.4	1.0	0	0.4	0	0.5	1.1	0	0.5	1.9	1.2	2.6	0	1.9	0.8

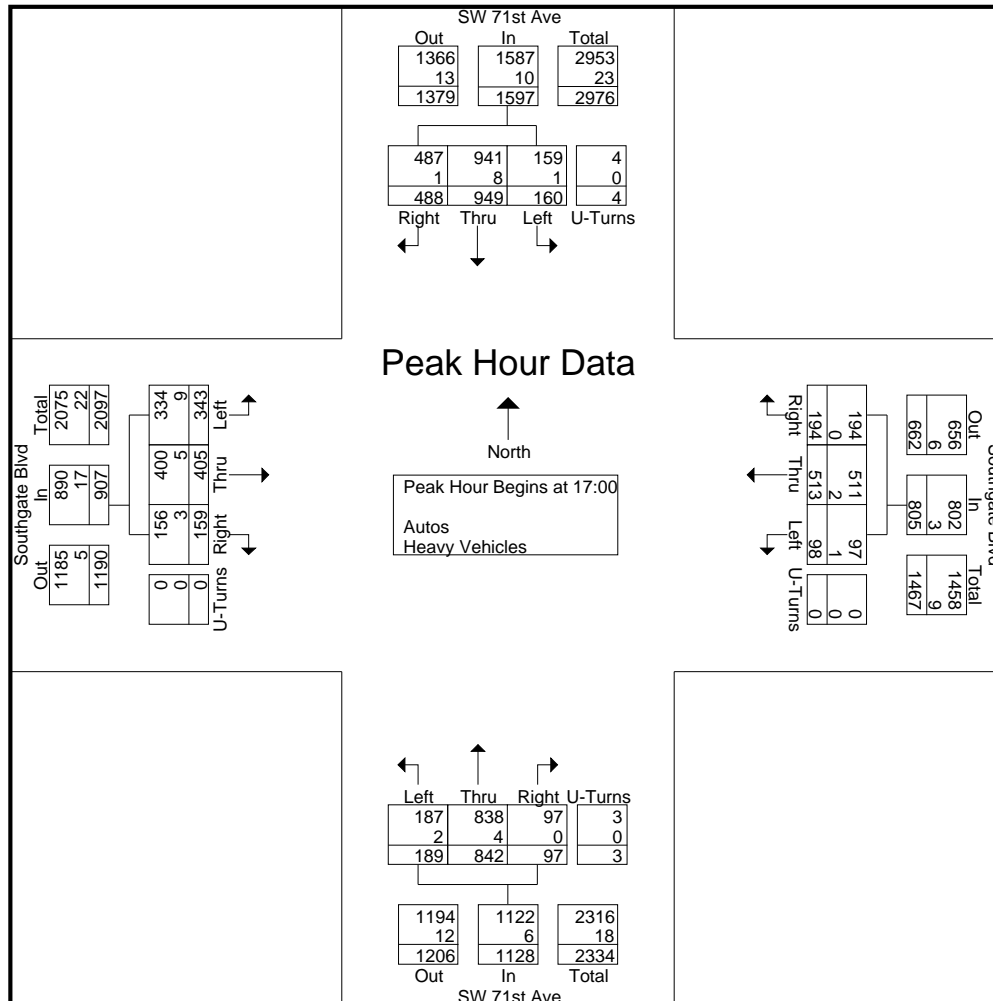

Traf Tech Engineering Inc.

File Name : 2-NW 76th Ave & Margate Blvd

Site Code : 00000000

Start Date : 5/11/2022

Page No : 1

Groups Printed- Peds & Bikes

Start Time	NW 76th Ave From North				Margate Blvd From East				NW 76th Ave From South				Margate Blvd From West				Int. Total	
	Bikes			Peds	Bikes			Peds	Bikes			Peds	Bikes			Peds		
07:00	0	0	0	0	0	0	0	0	0	0	0	0	0	0	0	0	1	2
07:15	0	0	0	0	0	0	0	0	2	0	0	0	0	0	0	0	0	2
07:30	0	0	0	0	0	0	0	0	0	0	0	0	2	0	0	0	0	2
07:45	0	0	0	0	0	0	0	0	1	0	0	0	0	0	0	0	0	2
Total	0	0	0	0	0	0	0	0	3	0	0	0	3	0	0	0	2	8
*** BREAK ***																		
08:15	0	0	0	0	0	0	0	0	1	0	0	0	0	0	0	0	2	3
08:30	0	0	0	0	0	0	0	0	0	0	0	0	1	0	0	0	1	2
08:45	0	0	0	0	0	0	0	0	0	0	0	0	2	0	0	0	1	3
Total	0	0	0	0	0	0	0	0	1	0	0	0	3	0	0	0	4	8
*** BREAK ***																		
17:00	0	0	0	0	0	0	0	0	1	0	0	0	0	0	0	0	0	1
*** BREAK ***																		
17:30	0	0	0	0	0	0	0	0	1	0	0	0	0	0	0	0	1	2
17:45	0	0	0	0	0	0	0	0	0	0	0	0	0	0	0	0	1	1
Total	0	0	0	0	0	0	0	0	2	0	0	0	0	0	0	0	2	4
Grand Total	0	0	0	0	0	0	0	0	6	0	0	0	6	0	0	0	8	20
Apprch %	0	0	0	0	0	0	0	0	100	0	0	0	100	0	0	0	100	
Total %	0	0	0	0	0	0	0	0	30	0	0	0	30	0	0	0	40	

Traf Tech Engineering Inc.

File Name : 2-NW 76th Ave & Margate Blvd
 Site Code : 00000000
 Start Date : 5/11/2022
 Page No : 1

Groups Printed- Autos - Heavy Vehicles

Start Time	NW 76th Ave From North					Margate Blvd From East					NW 76th Ave From South					Margate Blvd From West					Int. Total
	Right	Thru	Left	U-Turns	App. Total	Right	Thru	Left	U-Turns	App. Total	Right	Thru	Left	U-Turns	App. Total	Right	Thru	Left	U-Turns	App. Total	
07:00	0	0	0	0	0	0	8	6	0	14	7	0	8	0	15	50	32	0	0	82	111
07:15	0	0	0	0	0	0	12	9	0	21	7	0	9	0	16	32	16	0	0	48	85
07:30	0	0	0	0	0	0	11	19	1	31	21	0	7	0	28	39	35	0	0	74	133
07:45	0	0	0	0	0	0	18	13	0	31	17	0	18	0	35	27	19	0	0	46	112
Total	0	0	0	0	0	0	49	47	1	97	52	0	42	0	94	148	102	0	0	250	441
08:00	0	0	0	0	0	0	17	18	0	35	6	0	24	0	30	33	23	0	0	56	121
08:15	0	0	0	0	0	0	5	10	0	15	8	0	15	0	23	38	11	0	0	49	87
08:30	0	0	0	0	0	0	11	12	0	23	8	0	19	0	27	33	26	0	0	59	109
08:45	0	0	0	0	0	0	9	25	0	34	12	0	15	0	27	32	26	0	0	58	119
Total	0	0	0	0	0	0	42	65	0	107	34	0	73	0	107	136	86	0	0	222	436
*** BREAK ***																					
16:00	0	0	0	0	0	0	20	28	0	48	6	0	34	0	40	21	19	0	0	40	128
16:15	0	0	0	0	0	0	29	14	0	43	11	0	26	0	37	20	19	0	0	39	119
16:30	0	0	0	0	0	0	30	14	0	44	8	0	35	0	43	23	16	0	0	39	126
16:45	0	0	0	0	0	0	25	28	0	53	12	0	34	0	46	17	18	0	0	35	134
Total	0	0	0	0	0	0	104	84	0	188	37	0	129	0	166	81	72	0	0	153	507
17:00	0	0	0	0	0	0	25	17	0	42	10	0	29	0	39	17	19	0	0	36	117
17:15	0	0	0	0	0	0	35	33	0	68	14	0	35	0	49	28	8	0	0	36	153
17:30	0	0	0	0	0	0	18	31	1	50	14	0	38	0	52	17	13	0	0	30	132
17:45	0	0	0	0	0	0	17	23	1	41	10	0	35	0	45	26	14	0	0	40	126
Total	0	0	0	0	0	0	95	104	2	201	48	0	137	0	185	88	54	0	0	142	528
Grand Total	0	0	0	0	0	0	290	300	3	593	171	0	381	0	552	453	314	0	0	767	1912
Apprch %	0	0	0	0	0	0	48.9	50.6	0.5		31	0	69	0		59.1	40.9	0	0		
Total %	0	0	0	0	0	0	15.2	15.7	0.2	31	8.9	0	19.9	0	28.9	23.7	16.4	0	0	40.1	
Autos	0	0	0	0	0	0	285	299	3	587	168	0	375	0	543	444	309	0	0	753	1883
% Autos	0	0	0	0	0	0	98.3	99.7	100	99	98.2	0	98.4	0	98.4	98	98.4	0	0	98.2	98.5
Heavy Vehicles																					
% Heavy Vehicles	0	0	0	0	0	0	1.7	0.3	0	1	1.8	0	1.6	0	1.6	2	1.6	0	0	1.8	1.5

Traf Tech Engineering Inc.

File Name : 2-NW 76th Ave & Margate Blvd

Site Code : 00000000

Start Date : 5/11/2022

Page No : 2

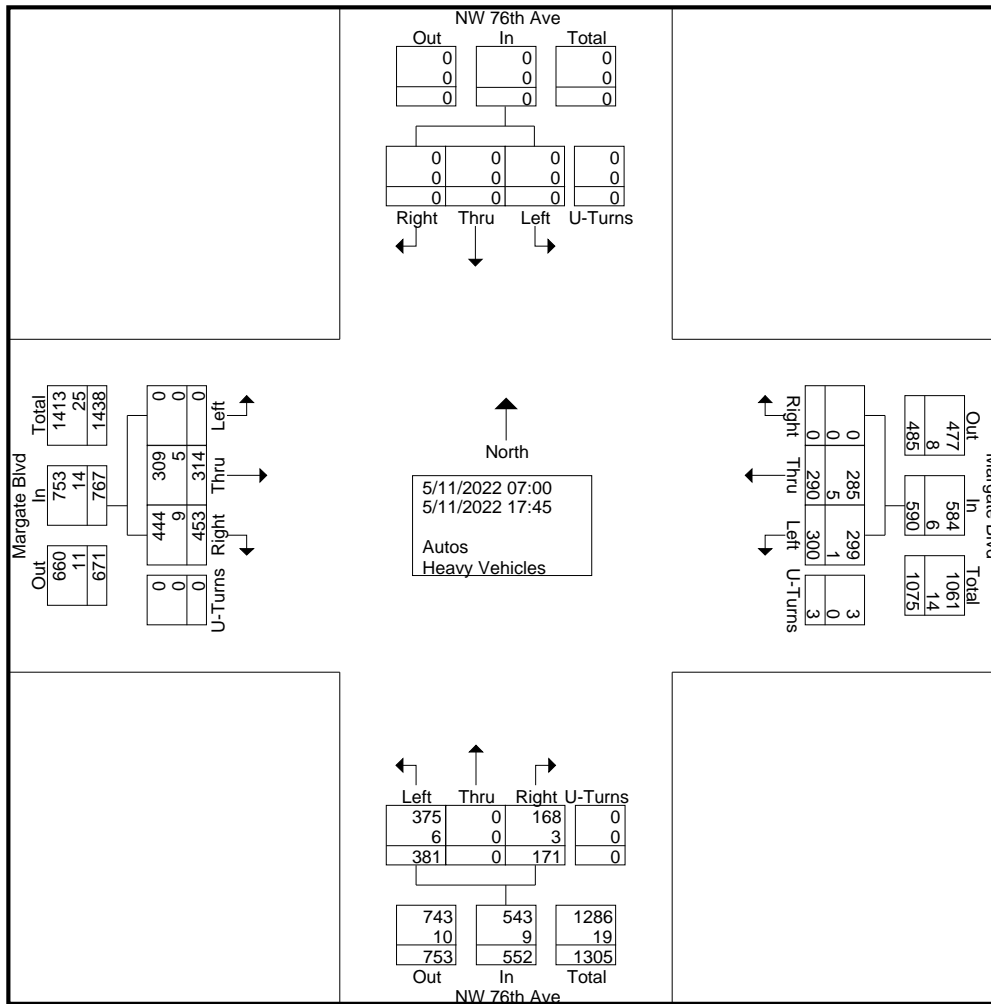

Traf Tech Engineering Inc.

File Name : 2-NW 76th Ave & Margate Blvd
 Site Code : 00000000
 Start Date : 5/11/2022
 Page No : 3

Start Time	NW 76th Ave From North					Margate Blvd From East					NW 76th Ave From South					Margate Blvd From West					Int. Total
	Right	Thru	Left	U-Turns	App. Total	Right	Thru	Left	U-Turns	App. Total	Right	Thru	Left	U-Turns	App. Total	Right	Thru	Left	U-Turns	App. Total	
Peak Hour Analysis From 07:00 to 17:45 - Peak 1 of 1																					
Peak Hour for Entire Intersection Begins at 16:45																					
16:45	0	0	0	0	0	0	25	28	0	53	12	0	34	0	46	17	18	0	0	35	134
17:00	0	0	0	0	0	0	25	17	0	42	10	0	29	0	39	17	19	0	0	36	117
17:15	0	0	0	0	0	0	35	33	0	68	14	0	35	0	49	28	8	0	0	36	153
17:30	0	0	0	0	0	0	18	31	1	50	14	0	38	0	52	17	13	0	0	30	132
Total Volume	0	0	0	0	0	0	103	109	1	213	50	0	136	0	186	79	58	0	0	137	536
% App. Total	0	0	0	0	0	0	48.4	51.2	0.5		26.9	0	73.1	0		57.7	42.3	0	0		
PHF	.000	.000	.000	.000	.000	.000	.736	.826	.250	.783	.893	.000	.895	.000	.894	.705	.763	.000	.000	.951	.876
Autos	0	0	0	0	0	0	102	109	1	212	50	0	132	0	182	79	57	0	0	136	530
% Autos	0	0	0	0	0	0	99.0	100	100	99.5	100	0	97.1	0	97.8	100	98.3	0	0	99.3	98.9
Heavy Vehicles																					
% Heavy Vehicles	0	0	0	0	0	0	1.0	0	0	0.5	0	0	2.9	0	2.2	0	1.7	0	0	0.7	1.1

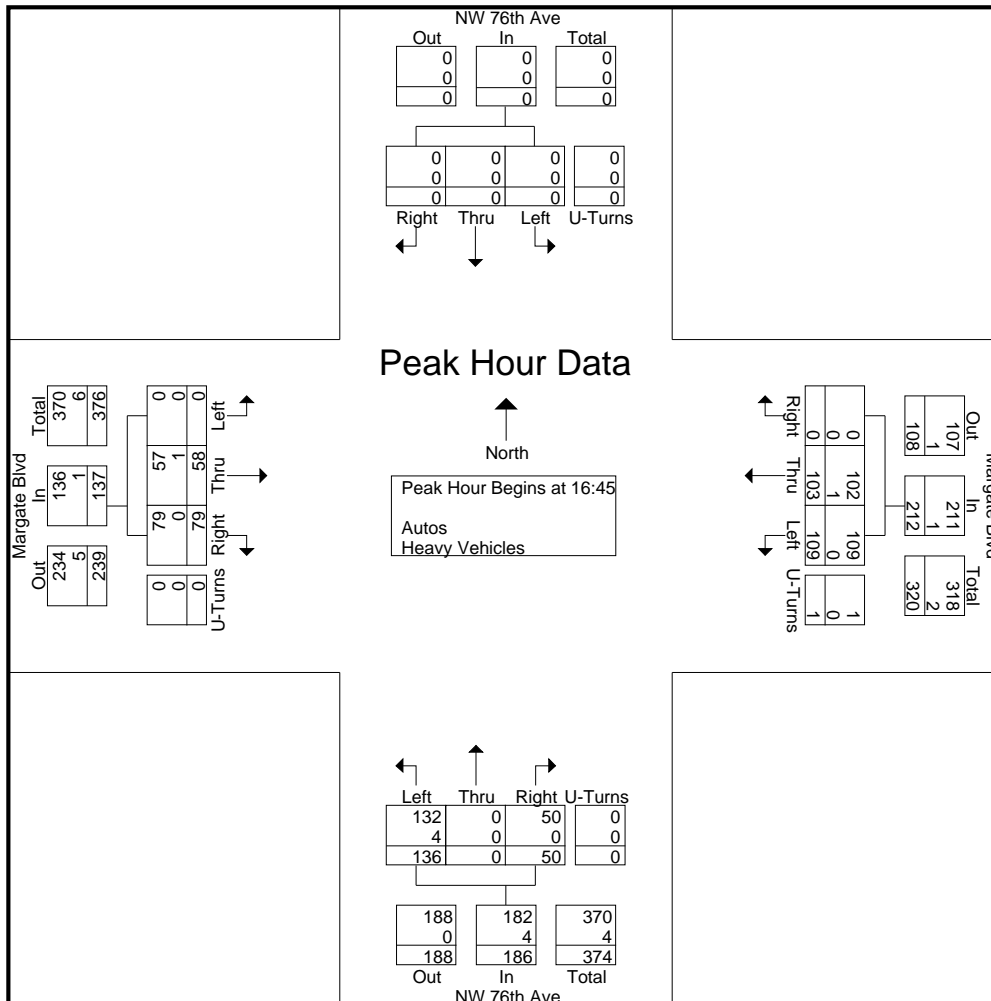

Traf Tech Engineering Inc.

File Name : 2-NW 76th Ave & Margate Blvd

Site Code : 00000000

Start Date : 5/11/2022

Page No : 4

Start Time	NW 76th Ave From North					Margate Blvd From East					NW 76th Ave From South					Margate Blvd From West					Int. Total
	Right	Thru	Left	U-Turns	App. Total	Right	Thru	Left	U-Turns	App. Total	Right	Thru	Left	U-Turns	App. Total	Right	Thru	Left	U-Turns	App. Total	
Peak Hour Analysis From 07:00 to 08:45 - Peak 1 of 1																					
Peak Hour for Entire Intersection Begins at 07:30																					
07:30	0	0	0	0	0	0	11	19	1	31	21	0	7	0	28	39	35	0	0	74	133
07:45	0	0	0	0	0	0	18	13	0	31	17	0	18	0	35	27	19	0	0	46	112
08:00	0	0	0	0	0	0	17	18	0	35	6	0	24	0	30	33	23	0	0	56	121
08:15	0	0	0	0	0	0	5	10	0	15	8	0	15	0	23	38	11	0	0	49	87
Total Volume	0	0	0	0	0	0	51	60	1	112	52	0	64	0	116	137	88	0	0	225	453
% App. Total	0	0	0	0	0	0	45.5	53.6	0.9		44.8	0	55.2	0		60.9	39.1	0	0		
PHF	.000	.000	.000	.000	.000	.000	.708	.789	.250	.800	.619	.000	.667	.000	.829	.878	.629	.000	.000	.760	.852
Autos	0	0	0	0	0	0	50	59	1	110	50	0	63	0	113	135	88	0	0	223	446
% Autos	0	0	0	0	0	0	98.0	98.3	100	98.2	96.2	0	98.4	0	97.4	98.5	100	0	0	99.1	98.5
Heavy Vehicles																					
% Heavy Vehicles	0	0	0	0	0	0	2.0	1.7	0	1.8	3.8	0	1.6	0	2.6	1.5	0	0	0	0.9	1.5

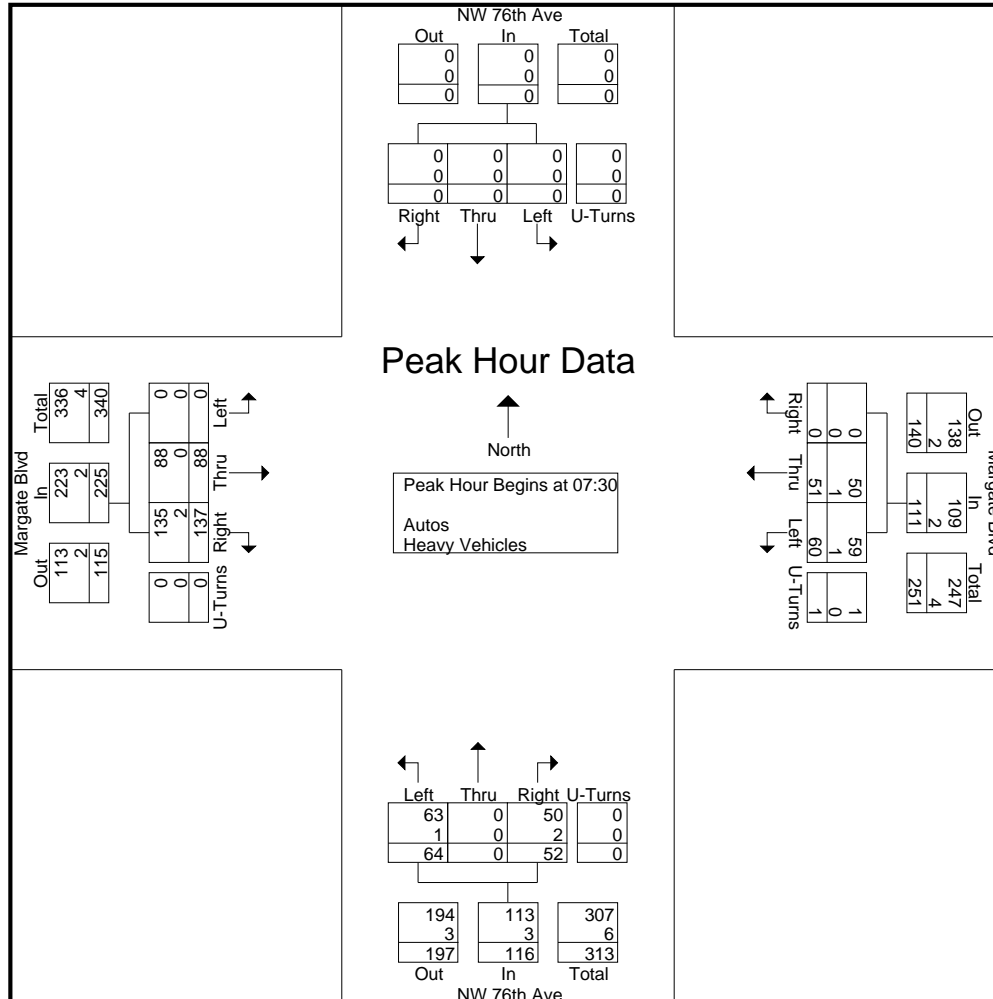

Traf Tech Engineering Inc.

File Name : 2-NW 76th Ave & Margate Blvd

Site Code : 00000000

Start Date : 5/11/2022

Page No : 5

Start Time	NW 76th Ave From North					Margate Blvd From East					NW 76th Ave From South					Margate Blvd From West					Int. Total
	Right	Thru	Left	U-Turns	App. Total	Right	Thru	Left	U-Turns	App. Total	Right	Thru	Left	U-Turns	App. Total	Right	Thru	Left	U-Turns	App. Total	
Peak Hour Analysis From 16:00 to 17:45 - Peak 1 of 1																					
Peak Hour for Entire Intersection Begins at 16:45																					
16:45	0	0	0	0	0	0	25	28	0	53	12	0	34	0	46	17	18	0	0	35	134
17:00	0	0	0	0	0	0	25	17	0	42	10	0	29	0	39	17	19	0	0	36	117
17:15	0	0	0	0	0	0	35	33	0	68	14	0	35	0	49	28	8	0	0	36	153
17:30	0	0	0	0	0	0	18	31	1	50	14	0	38	0	52	17	13	0	0	30	132
Total Volume	0	0	0	0	0	0	103	109	1	213	50	0	136	0	186	79	58	0	0	137	536
% App. Total	0	0	0	0	0	0	48.4	51.2	0.5		26.9	0	73.1	0		57.7	42.3	0	0		
PHF	.000	.000	.000	.000	.000	.000	.736	.826	.250	.783	.893	.000	.895	.000	.894	.705	.763	.000	.000	.951	.876
Autos	0	0	0	0	0	0	102	109	1	212	50	0	132	0	182	79	57	0	0	136	530
% Autos	0	0	0	0	0	0	99.0	100	100	99.5	100	0	97.1	0	97.8	100	98.3	0	0	99.3	98.9
Heavy Vehicles																					
% Heavy Vehicles	0	0	0	0	0	0	1.0	0	0	0.5	0	0	2.9	0	2.2	0	1.7	0	0	0.7	1.1

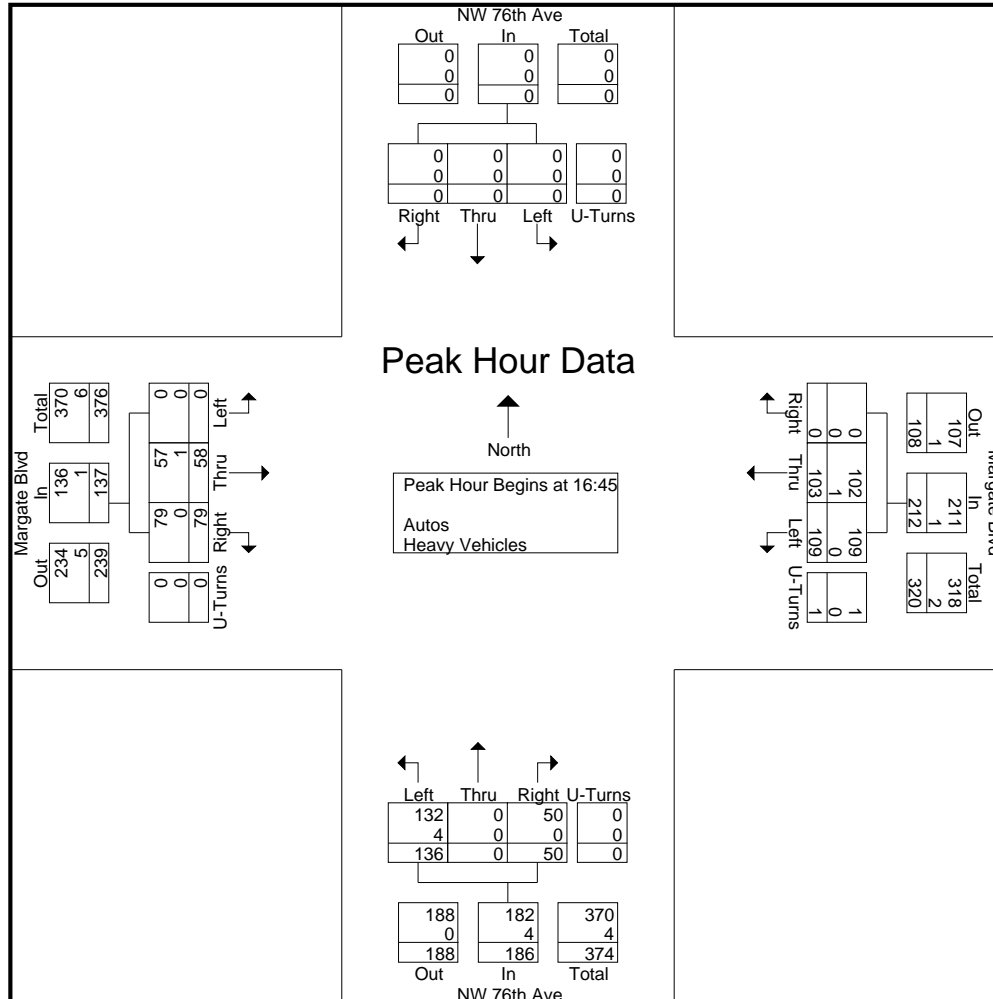

Traf Tech Engineering Inc.

File Name : 3-Rock Island Rd & Margate Blvd
 Site Code : 00000000
 Start Date : 5/11/2022
 Page No : 1

Groups Printed- Peds & Bikes

Start Time	Rock Island Rd From North				Margate Blvd From East				Rock Island Rd From South				Margate Blvd From West				Int. Total
	Bikes			Peds	Bikes			Peds	Bikes			Peds	Bikes			Peds	
*** BREAK ***																	
07:15	0	0	0	0	0	0	0	1	0	0	0	1	0	0	0	0	2
07:30	0	0	0	0	0	0	0	2	0	0	0	1	0	0	0	0	3
*** BREAK ***																	
Total	0	0	0	0	0	0	0	3	0	0	0	2	0	0	0	0	5
*** BREAK ***																	
08:15	0	0	0	2	0	0	0	0	0	0	0	0	0	0	0	1	3
08:30	0	0	0	1	0	0	0	0	0	0	0	0	0	1	0	1	3
08:45	0	0	0	0	0	0	0	0	0	0	0	0	0	1	0	1	2
Total	0	0	0	3	0	0	0	0	0	0	0	0	0	2	0	3	8
*** BREAK ***																	
16:15	0	0	0	0	0	0	0	0	0	0	0	0	0	0	0	2	2
*** BREAK ***																	
16:45	0	0	0	1	0	0	0	0	0	0	0	0	0	0	0	0	1
Total	0	0	0	1	0	0	0	0	0	0	0	0	0	0	0	2	3
*** BREAK ***																	
Grand Total	0	0	0	4	0	0	0	3	0	0	0	2	0	2	0	5	16
Apprch %	0	0	0	100	0	0	0	100	0	0	0	100	0	28.6	0	71.4	
Total %	0	0	0	25	0	0	0	18.8	0	0	0	12.5	0	12.5	0	31.2	

Traf Tech Engineering Inc.

File Name : 3-Rock Island Rd & Margate Blvd
 Site Code : 00000000
 Start Date : 5/11/2022
 Page No : 1

Groups Printed- Autos - Heavy Vehicles

Start Time	Rock Island Rd From North					Margate Blvd From East					Rock Island Rd From South					Margate Blvd From West					Int. Total
	Right	Thru	Left	U-Turns	App. Total	Right	Thru	Left	U-Turns	App. Total	Right	Thru	Left	U-Turns	App. Total	Right	Thru	Left	U-Turns	App. Total	
07:00	8	208	29	0	245	22	6	29	0	57	37	198	0	0	235	5	9	23	0	37	574
07:15	11	231	38	0	280	20	11	22	0	53	71	206	1	0	278	7	21	12	0	40	651
07:30	12	198	43	0	253	18	13	28	0	59	83	184	2	0	269	8	30	20	0	58	639
07:45	9	221	48	0	278	15	18	40	0	73	87	208	5	1	301	4	21	7	0	32	684
Total	40	858	158	0	1056	75	48	119	0	242	278	796	8	1	1083	24	81	62	0	167	2548
08:00	16	214	33	0	263	18	14	46	0	78	66	172	3	0	241	4	17	18	0	39	621
08:15	5	197	28	0	230	22	7	29	1	59	36	206	1	0	243	2	11	10	0	23	555
08:30	15	213	39	0	267	16	12	25	0	53	46	205	2	0	253	9	12	21	0	42	615
08:45	14	197	24	0	235	24	13	24	0	61	27	179	6	0	212	10	19	21	0	50	558
Total	50	821	124	0	995	80	46	124	1	251	175	762	12	0	949	25	59	70	0	154	2349
*** BREAK ***																					
16:00	20	185	27	0	232	37	33	46	0	116	35	188	1	0	224	10	12	15	0	37	609
16:15	21	232	16	0	269	26	22	34	0	82	33	198	14	2	247	2	13	16	1	32	630
16:30	20	171	17	0	208	26	28	27	0	81	34	191	5	0	230	7	10	9	0	26	545
16:45	23	197	24	0	244	26	35	30	0	91	51	200	6	0	257	6	8	10	0	24	616
Total	84	785	84	0	953	115	118	137	0	370	153	777	26	2	958	25	43	50	1	119	2400
17:00	18	216	24	0	258	43	27	35	0	105	31	233	7	0	271	4	13	10	0	27	661
17:15	23	207	31	0	261	44	35	43	0	122	35	226	9	1	271	7	6	21	1	35	689
17:30	20	208	23	1	252	28	36	47	0	111	37	173	5	1	216	3	9	13	0	25	604
17:45	20	202	22	0	244	32	21	35	0	88	38	197	3	0	238	4	8	14	0	26	596
Total	81	833	100	1	1015	147	119	160	0	426	141	829	24	2	996	18	36	58	1	113	2550
Grand Total	255	3297	466	1	4019	417	331	540	1	1289	747	3164	70	5	3986	92	219	240	2	553	9847
Apprch %	6.3	82	11.6	0		32.4	25.7	41.9	0.1		18.7	79.4	1.8	0.1		16.6	39.6	43.4	0.4		
Total %	2.6	33.5	4.7	0	40.8	4.2	3.4	5.5	0	13.1	7.6	32.1	0.7	0.1	40.5	0.9	2.2	2.4	0	5.6	
Autos	252	3272									3143										
% Autos	98.8	99.2	99.4	100	99.2	98.3	99.4	99.4	100	99.1	99.1	99.3	98.6	100	99.3	98.9	100	99.6	100	99.6	99.2
Heavy Vehicles																					
% Heavy Vehicles	1.2	0.8	0.6	0	0.8	1.7	0.6	0.6	0	0.9	0.9	0.7	1.4	0	0.7	1.1	0	0.4	0	0.4	0.8

Traf Tech Engineering Inc.

File Name : 3-Rock Island Rd & Margate Blvd

Site Code : 00000000

Start Date : 5/11/2022

Page No : 2

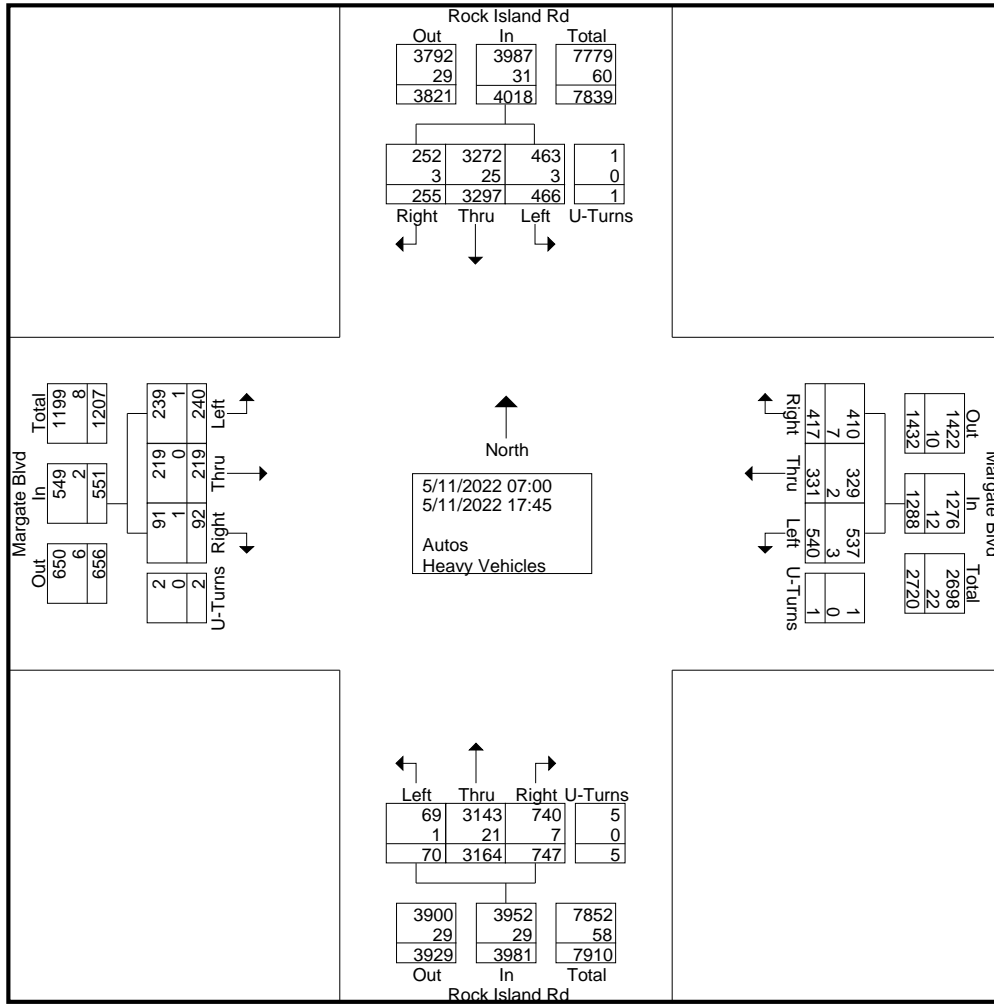

Traf Tech Engineering Inc.

File Name : 3-Rock Island Rd & Margate Blvd
 Site Code : 00000000
 Start Date : 5/11/2022
 Page No : 3

Start Time	Rock Island Rd From North					Margate Blvd From East					Rock Island Rd From South					Margate Blvd From West					Int. Total
	Right	Thru	Left	U-Turns	App. Total	Right	Thru	Left	U-Turns	App. Total	Right	Thru	Left	U-Turns	App. Total	Right	Thru	Left	U-Turns	App. Total	
Peak Hour Analysis From 07:00 to 17:45 - Peak 1 of 1																					
Peak Hour for Entire Intersection Begins at 07:15																					
07:15	11	231	38	0	280	20	11	22	0	53	71	206	1	0	278	7	21	12	0	40	651
07:30	12	198	43	0	253	18	13	28	0	59	83	184	2	0	269	8	30	20	0	58	639
07:45	9	221	48	0	278	15	18	40	0	73	87	208	5	1	301	4	21	7	0	32	684
08:00	16	214	33	0	263	18	14	46	0	78	66	172	3	0	241	4	17	18	0	39	621
Total Volume	48	864	162	0	1074	71	56	136	0	263	307	770	11	1	1089	23	89	57	0	169	2595
% App. Total	4.5	80.4	15.1	0		27	21.3	51.7	0		28.2	70.7	1	0.1		13.6	52.7	33.7	0		
PHF	.750	.935	.844	.000	.959	.888	.778	.739	.000	.843	.882	.925	.550	.250	.904	.719	.742	.713	.000	.728	.948
Autos	47	859	162	0	1068	71	56	136	0	263	304	767	10	1	1082	23	89	57	0	169	2582
% Autos	97.9	99.4	100	0	99.4	100	100	100	0	100	99.0	99.6	90.9	100	99.4	100	100	100	0	100	99.5
Heavy Vehicles																					
% Heavy Vehicles	2.1	0.6	0	0	0.6	0	0	0	0	0	1.0	0.4	9.1	0	0.6	0	0	0	0	0	0.5

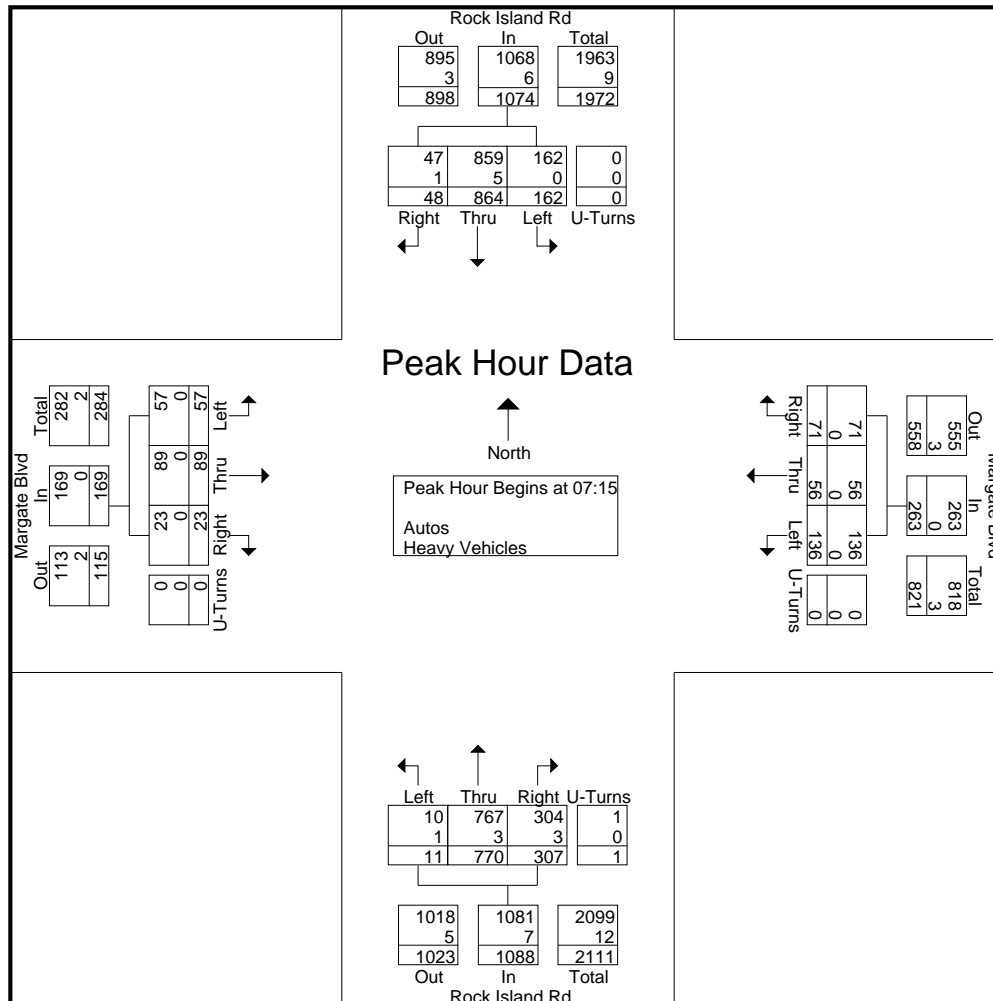

Traf Tech Engineering Inc.

File Name : 3-Rock Island Rd & Margate Blvd
 Site Code : 00000000
 Start Date : 5/11/2022
 Page No : 4

Start Time	Rock Island Rd From North					Margate Blvd From East					Rock Island Rd From South					Margate Blvd From West					Int. Total
	Right	Thru	Left	U-Turns	App. Total	Right	Thru	Left	U-Turns	App. Total	Right	Thru	Left	U-Turns	App. Total	Right	Thru	Left	U-Turns	App. Total	
Peak Hour Analysis From 07:00 to 08:45 - Peak 1 of 1																					
Peak Hour for Entire Intersection Begins at 07:15																					
07:15	11	231	38	0	280	20	11	22	0	53	71	206	1	0	278	7	21	12	0	40	651
07:30	12	198	43	0	253	18	13	28	0	59	83	184	2	0	269	8	30	20	0	58	639
07:45	9	221	48	0	278	15	18	40	0	73	87	208	5	1	301	4	21	7	0	32	684
08:00	16	214	33	0	263	18	14	46	0	78	66	172	3	0	241	4	17	18	0	39	621
Total Volume	48	864	162	0	1074	71	56	136	0	263	307	770	11	1	1089	23	89	57	0	169	2595
% App. Total	4.5	80.4	15.1	0		27	21.3	51.7	0		28.2	70.7	1	0.1		13.6	52.7	33.7	0		
PHF	.750	.935	.844	.000	.959	.888	.778	.739	.000	.843	.882	.925	.550	.250	.904	.719	.742	.713	.000	.728	.948
Autos	47	859	162	0	1068	71	56	136	0	263	304	767	10	1	1082	23	89	57	0	169	2582
% Autos	97.9	99.4	100	0	99.4	100	100	100	0	100	99.0	99.6	90.9	100	99.4	100	100	100	0	100	99.5
Heavy Vehicles																					
% Heavy Vehicles	2.1	0.6	0	0	0.6	0	0	0	0	0	1.0	0.4	9.1	0	0.6	0	0	0	0	0	0.5

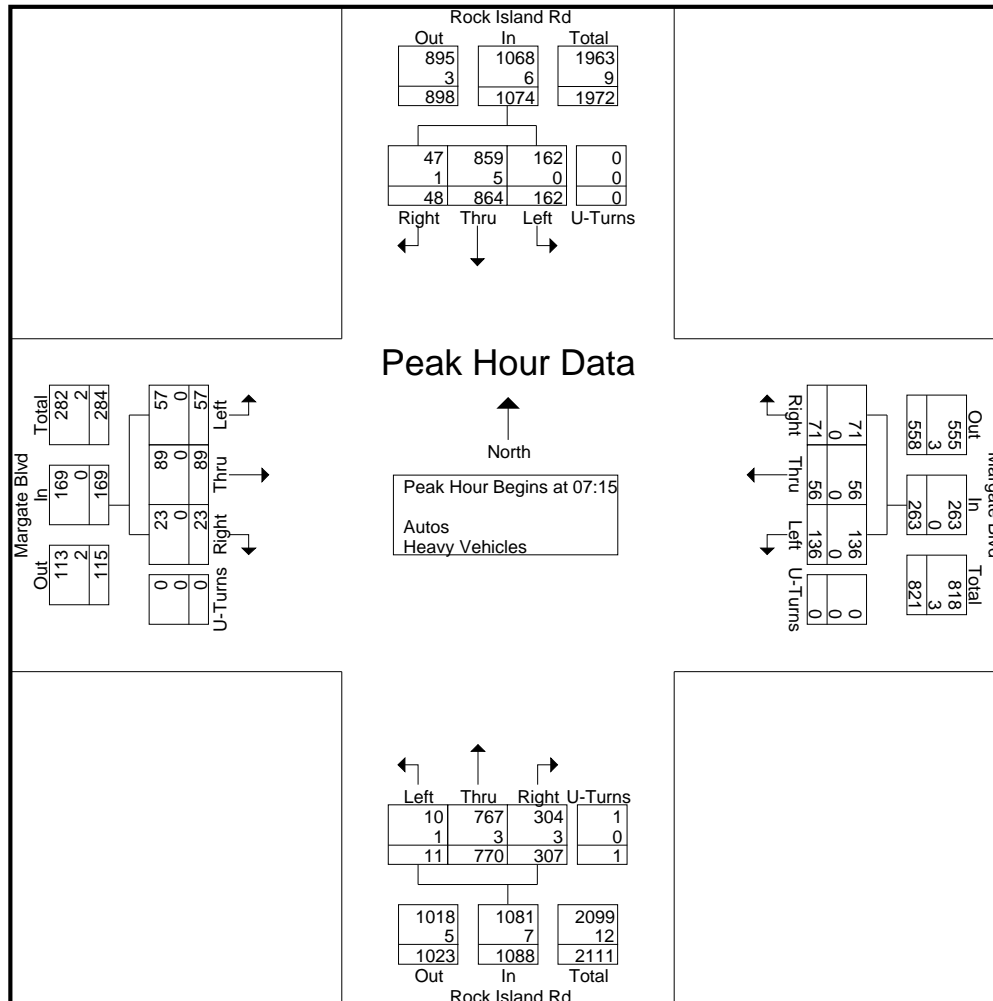

Traf Tech Engineering Inc.

File Name : 3-Rock Island Rd & Margate Blvd
 Site Code : 00000000
 Start Date : 5/11/2022
 Page No : 5

Start Time	Rock Island Rd From North					Margate Blvd From East					Rock Island Rd From South					Margate Blvd From West					Int. Total
	Right	Thru	Left	U-Turns	App. Total	Right	Thru	Left	U-Turns	App. Total	Right	Thru	Left	U-Turns	App. Total	Right	Thru	Left	U-Turns	App. Total	
Peak Hour Analysis From 16:00 to 17:45 - Peak 1 of 1																					
Peak Hour for Entire Intersection Begins at 16:45																					
16:45	23	197	24	0	244	26	35	30	0	91	51	200	6	0	257	6	8	10	0	24	616
17:00	18	216	24	0	258	43	27	35	0	105	31	233	7	0	271	4	13	10	0	27	661
17:15	23	207	31	0	261	44	35	43	0	122	35	226	9	1	271	7	6	21	1	35	689
17:30	20	208	23	1	252	28	36	47	0	111	37	173	5	1	216	3	9	13	0	25	604
Total Volume	84	828	102	1	1015	141	133	155	0	429	154	832	27	2	1015	20	36	54	1	111	2570
% App. Total	8.3	81.6	10	0.1		32.9	31	36.1	0		15.2	82	2.7	0.2		18	32.4	48.6	0.9		
PHF	.913	.958	.823	.250	.972	.801	.924	.824	.000	.879	.755	.893	.750	.500	.936	.714	.692	.643	.250	.793	.933
Autos	84	821	101	1	1007	139	132	155	0	426	152	827	27	2	1008	20	36	54	1	111	2552
% Autos	100	99.2	99.0	100	99.2	98.6	99.2	100	0	99.3	98.7	99.4	100	100	99.3	100	100	100	100	100	99.3
Heavy Vehicles																					
% Heavy Vehicles	0	0.8	1.0	0	0.8	1.4	0.8	0	0	0.7	1.3	0.6	0	0	0.7	0	0	0	0	0	0.7

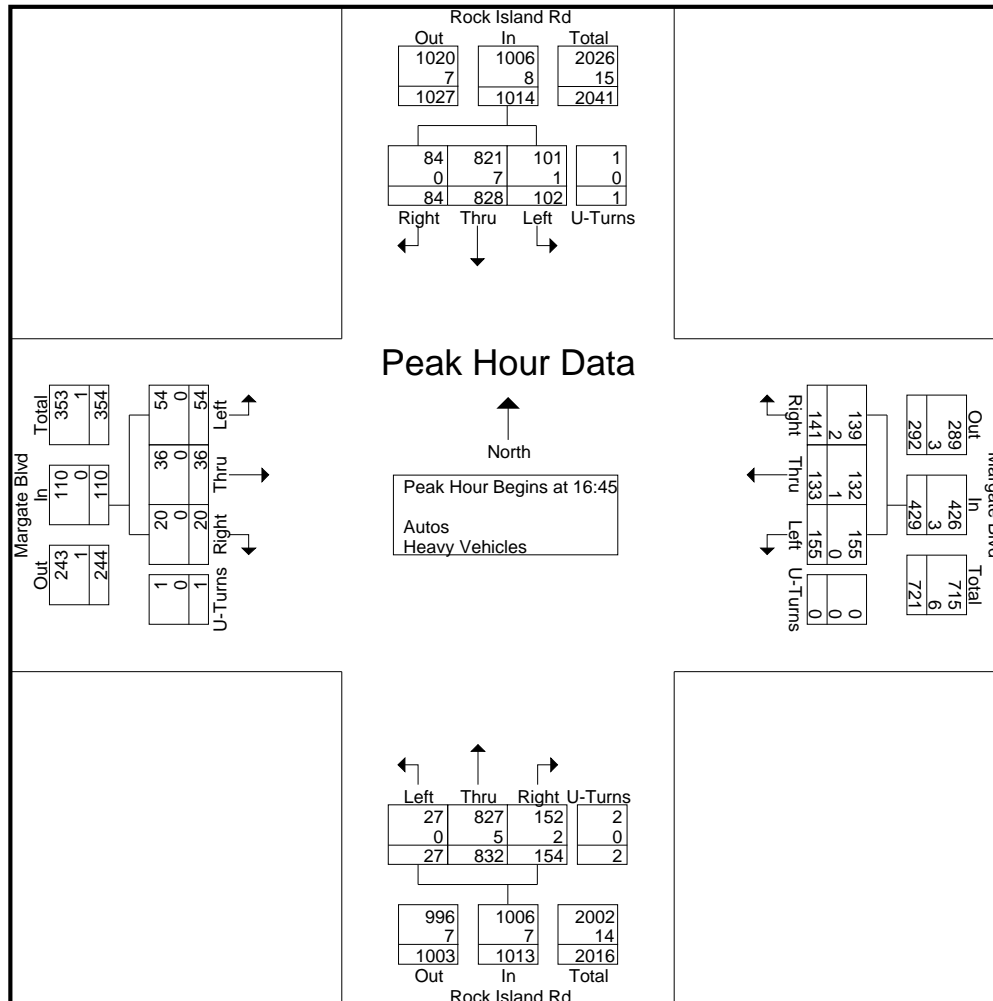

Traf Tech Engineering Inc.

File Name : 4-SR-7 & Margate Blvd
 Site Code : 00000000
 Start Date : 5/11/2022
 Page No : 1

Groups Printed- Peds & Bikes

Start Time	SR-7 From North				Margate Blvd From East				SR-7 From South				Margate Blvd From West				Int. Total
	Bikes			Peds	Bikes			Peds	Bikes			Peds	Bikes			Peds	
*** BREAK ***																	
07:45	0	0	0	0	0	0	0	0	0	0	0	1	0	0	0	1	2
Total	0	0	0	0	0	0	0	0	0	0	0	1	0	0	0	1	2
08:00	0	0	0	0	0	0	0	0	0	0	0	1	0	0	0	0	1
*** BREAK ***																	
08:45	0	0	0	1	0	0	0	0	0	0	0	2	0	0	0	0	3
Total	0	0	0	1	0	0	0	0	0	0	0	3	0	0	0	0	4
*** BREAK ***																	
16:00	0	0	0	0	0	0	0	0	0	0	0	2	0	0	0	0	2
16:15	0	0	0	0	0	0	0	0	0	0	0	1	0	0	0	0	1
16:30	0	0	0	0	0	0	0	0	0	0	0	1	0	0	0	1	2
*** BREAK ***																	
Total	0	0	0	0	0	0	0	0	0	0	0	4	0	0	0	1	5
*** BREAK ***																	
17:15	0	0	0	0	0	0	0	0	0	0	0	2	0	0	0	0	2
*** BREAK ***																	
Total	0	0	0	0	0	0	0	0	0	0	0	2	0	0	0	0	2
Grand Total	0	0	0	1	0	0	0	0	0	0	0	10	0	0	0	2	13
Apprch %	0	0	0	100	0	0	0	0	0	0	0	100	0	0	0	100	
Total %	0	0	0	7.7	0	0	0	0	0	0	0	76.9	0	0	0	15.4	

Traf Tech Engineering Inc.

File Name : 4-SR-7 & Margate Blvd
 Site Code : 00000000
 Start Date : 5/11/2022
 Page No : 1

Groups Printed- Autos - Heavy Vehicles

Start Time	SR-7 From North					Margate Blvd From East					SR-7 From South					Margate Blvd From West					Int. Total
	Right	Thru	Left	U-Turns	App. Total	Right	Thru	Left	U-Turns	App. Total	Right	Thru	Left	U-Turns	App. Total	Right	Thru	Left	U-Turns	App. Total	
07:00	14	340	0	2	356	0	0	0	0	0	0	463	8	0	471	44	0	77	0	121	948
07:15	8	303	0	2	313	0	0	0	0	0	0	488	11	0	499	37	0	94	0	131	943
07:30	9	391	0	1	401	0	0	0	0	0	0	511	5	1	517	44	0	106	0	150	1068
07:45	18	345	0	2	365	0	0	0	0	0	0	524	7	0	531	49	0	157	0	206	1102
Total	49	1379	0	7	1435	0	0	0	0	0	0	1986	31	1	2018	174	0	434	0	608	4061
08:00	32	370	0	0	402	0	0	0	0	0	0	509	11	0	520	30	0	136	0	166	1088
08:15	33	478	0	2	513	0	0	0	0	0	0	425	10	0	435	41	0	74	0	115	1063
08:30	18	389	0	3	410	0	0	0	0	0	0	425	11	2	438	29	0	81	0	110	958
08:45	26	396	0	2	424	0	0	0	0	0	0	402	13	0	415	31	0	92	0	123	962
Total	109	1633	0	7	1749	0	0	0	0	0	0	1761	45	2	1808	131	0	383	0	514	4071
*** BREAK ***																					
16:00	42	458	0	8	508	0	0	0	0	0	0	423	9	2	434	27	1	57	0	85	1027
16:15	40	484	0	5	529	0	0	0	0	0	0	388	32	3	423	26	0	53	0	79	1031
16:30	30	445	0	3	478	0	0	0	0	0	0	341	23	3	367	22	0	52	0	74	919
16:45	36	522	0	1	559	0	0	0	0	0	0	406	24	5	435	16	0	41	0	57	1051
Total	148	1909	0	17	2074	0	0	0	0	0	0	1558	88	13	1659	91	1	203	0	295	4028
17:00	30	463	0	3	496	0	0	0	0	0	0	405	22	3	430	20	0	63	0	83	1009
17:15	49	504	1	1	555	0	0	0	0	0	0	348	18	2	368	19	0	46	0	65	988
17:30	32	507	0	6	545	0	0	0	0	0	0	427	21	2	450	14	0	40	0	54	1049
17:45	45	425	0	1	471	0	0	0	0	0	0	371	9	2	382	15	0	64	0	79	932
Total	156	1899	1	11	2067	0	0	0	0	0	0	1551	70	9	1630	68	0	213	0	281	3978
Grand Total	462	6820	1	42	7325	0	0	0	0	0	0	6856	234	25	7115	464	1	1233	0	1698	16138
Apprch %	6.3	93.1	0	0.6		0	0	0	0	0	0	96.4	3.3	0.4		27.3	0.1	72.6	0		
Total %	2.9	42.3	0	0.3	45.4	0	0	0	0	0	0	42.5	1.4	0.2	44.1	2.9	0	7.6	0	10.5	
Autos	450	6673										6719						1209			15796
% Autos	97.4	97.8	100	100	97.8	0	0	0	0	0	0	98	96.2	100	97.9	97.2	100	98.1	0	97.8	97.9
Heavy Vehicles																					
% Heavy Vehicles	2.6	2.2	0	0	2.2	0	0	0	0	0	0	2	3.8	0	2.1	2.8	0	1.9	0	2.2	2.1

Traf Tech Engineering Inc.

File Name : 4-SR-7 & Margate Blvd

Site Code : 00000000

Start Date : 5/11/2022

Page No : 2

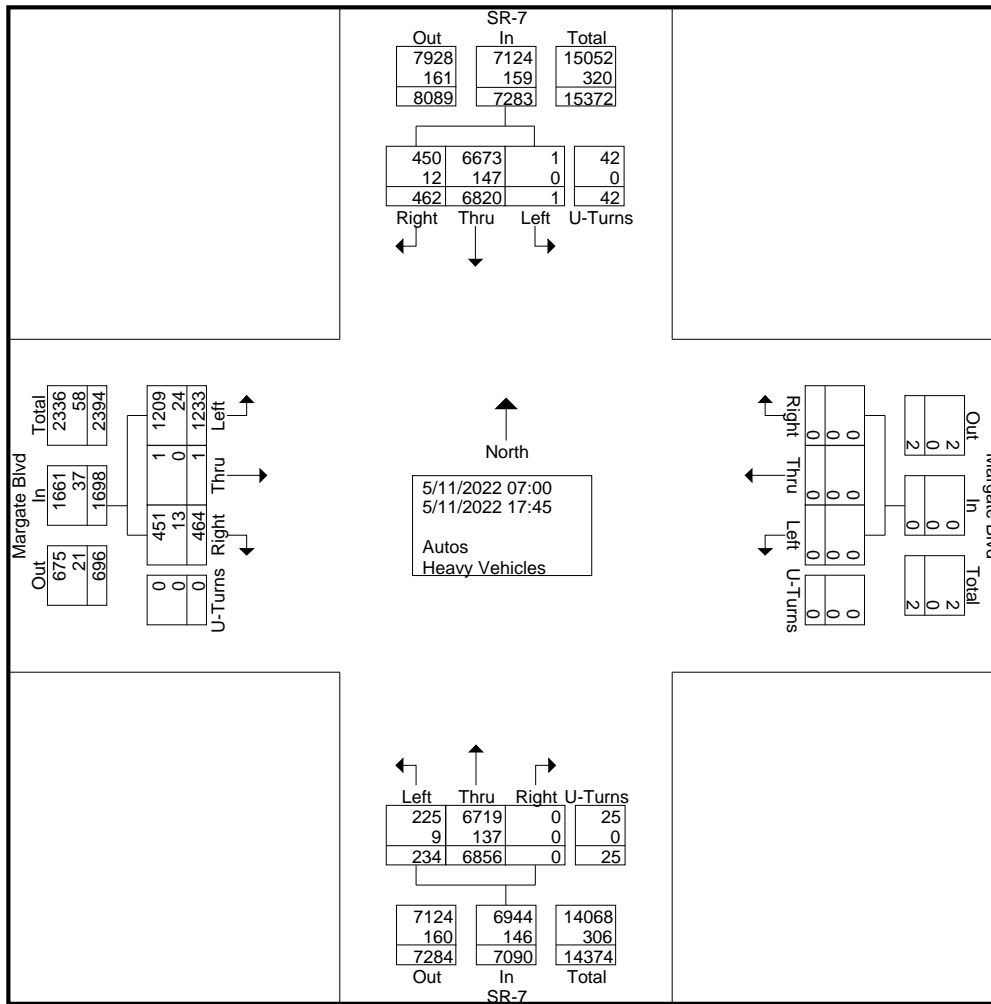

Traf Tech Engineering Inc.

File Name : 4-SR-7 & Margate Blvd
 Site Code : 00000000
 Start Date : 5/11/2022
 Page No : 3

Start Time	SR-7 From North					Margate Blvd From East					SR-7 From South					Margate Blvd From West					Int. Total
	Right	Thru	Left	U-Turns	App. Total	Right	Thru	Left	U-Turns	App. Total	Right	Thru	Left	U-Turns	App. Total	Right	Thru	Left	U-Turns	App. Total	
Peak Hour Analysis From 07:00 to 17:45 - Peak 1 of 1																					
Peak Hour for Entire Intersection Begins at 07:30																					
07:30	9	391	0	1	401	0	0	0	0	0	0	511	5	1	517	44	0	106	0	150	1068
07:45	18	345	0	2	365	0	0	0	0	0	0	524	7	0	531	49	0	157	0	206	1102
08:00	32	370	0	0	402	0	0	0	0	0	0	509	11	0	520	30	0	136	0	166	1088
08:15	33	478	0	2	513	0	0	0	0	0	0	425	10	0	435	41	0	74	0	115	1063
Total Volume	92	1584	0	5	1681	0	0	0	0	0	0	1969	33	1	2003	164	0	473	0	637	4321
% App. Total	5.5	94.2	0	0.3		0	0	0	0	0	0	98.3	1.6	0		25.7	0	74.3	0		
PHF	.697	.828	.000	.625	.819	.000	.000	.000	.000	.000	.000	.939	.750	.250	.943	.837	.000	.753	.000	.773	.980
Autos	91	1532										1931									
% Autos	98.9	96.7	0	100	96.8	0	0	0	0	0	0	98.1	90.9	100	98.0	98.2	0	98.7	0	98.6	97.6
Heavy Vehicles																					
% Heavy Vehicles	1.1	3.3	0	0	3.2	0	0	0	0	0	0	1.9	9.1	0	2.0	1.8	0	1.3	0	1.4	2.4

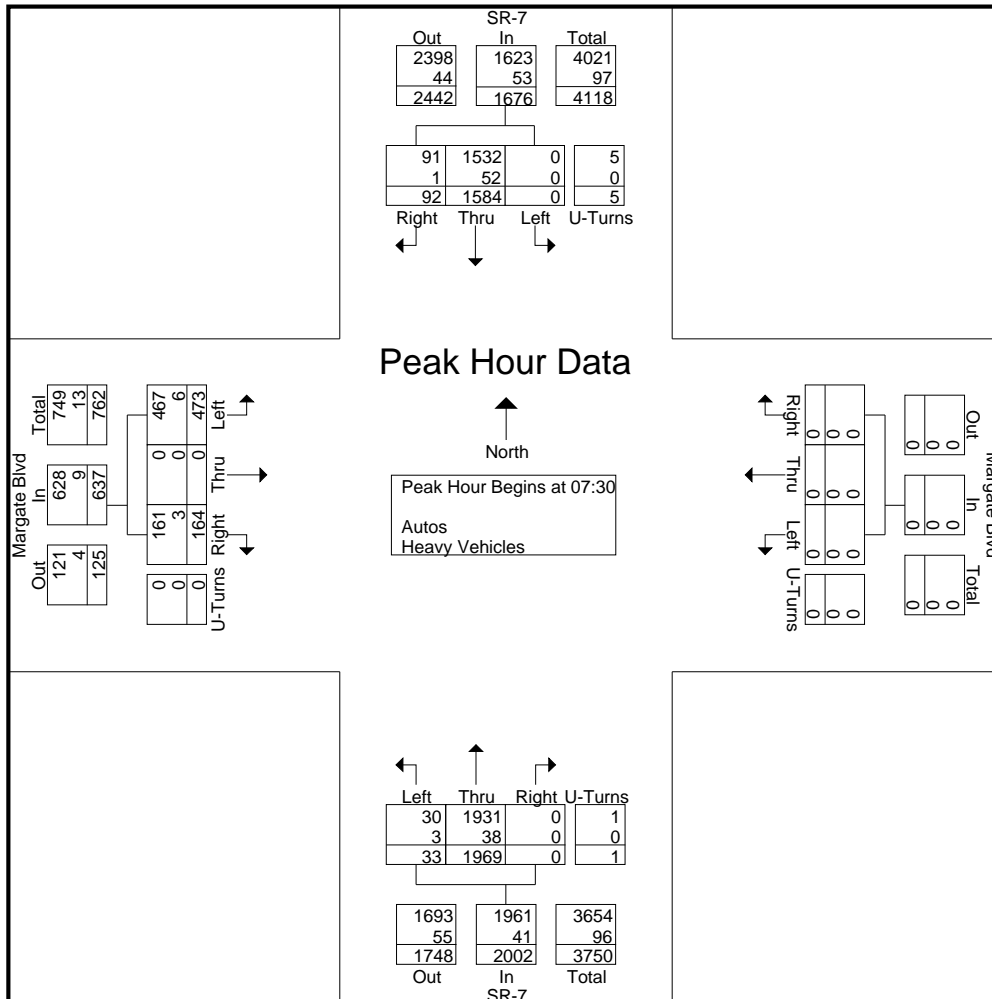

Traf Tech Engineering Inc.

File Name : 4-SR-7 & Margate Blvd
 Site Code : 00000000
 Start Date : 5/11/2022
 Page No : 4

Start Time	SR-7 From North					Margate Blvd From East					SR-7 From South					Margate Blvd From West					Int. Total
	Right	Thru	Left	U-Turns	App. Total	Right	Thru	Left	U-Turns	App. Total	Right	Thru	Left	U-Turns	App. Total	Right	Thru	Left	U-Turns	App. Total	
Peak Hour Analysis From 07:00 to 08:45 - Peak 1 of 1																					
Peak Hour for Entire Intersection Begins at 07:30																					
07:30	9	391	0	1	401	0	0	0	0	0	0	511	5	1	517	44	0	106	0	150	1068
07:45	18	345	0	2	365	0	0	0	0	0	0	524	7	0	531	49	0	157	0	206	1102
08:00	32	370	0	0	402	0	0	0	0	0	0	509	11	0	520	30	0	136	0	166	1088
08:15	33	478	0	2	513	0	0	0	0	0	0	425	10	0	435	41	0	74	0	115	1063
Total Volume	92	1584	0	5	1681	0	0	0	0	0	0	1969	33	1	2003	164	0	473	0	637	4321
% App. Total	5.5	94.2	0	0.3		0	0	0	0	0	0	98.3	1.6	0		25.7	0	74.3	0		
PHF	.697	.828	.000	.625	.819	.000	.000	.000	.000	.000	.000	.939	.750	.250	.943	.837	.000	.753	.000	.773	.980
Autos	91	1532										1931									
% Autos	98.9	96.7	0	100	96.8	0	0	0	0	0	0	98.1	90.9	100	98.0	98.2	0	98.7	0	98.6	97.6
Heavy Vehicles																					
% Heavy Vehicles	1.1	3.3	0	0	3.2	0	0	0	0	0	0	1.9	9.1	0	2.0	1.8	0	1.3	0	1.4	2.4

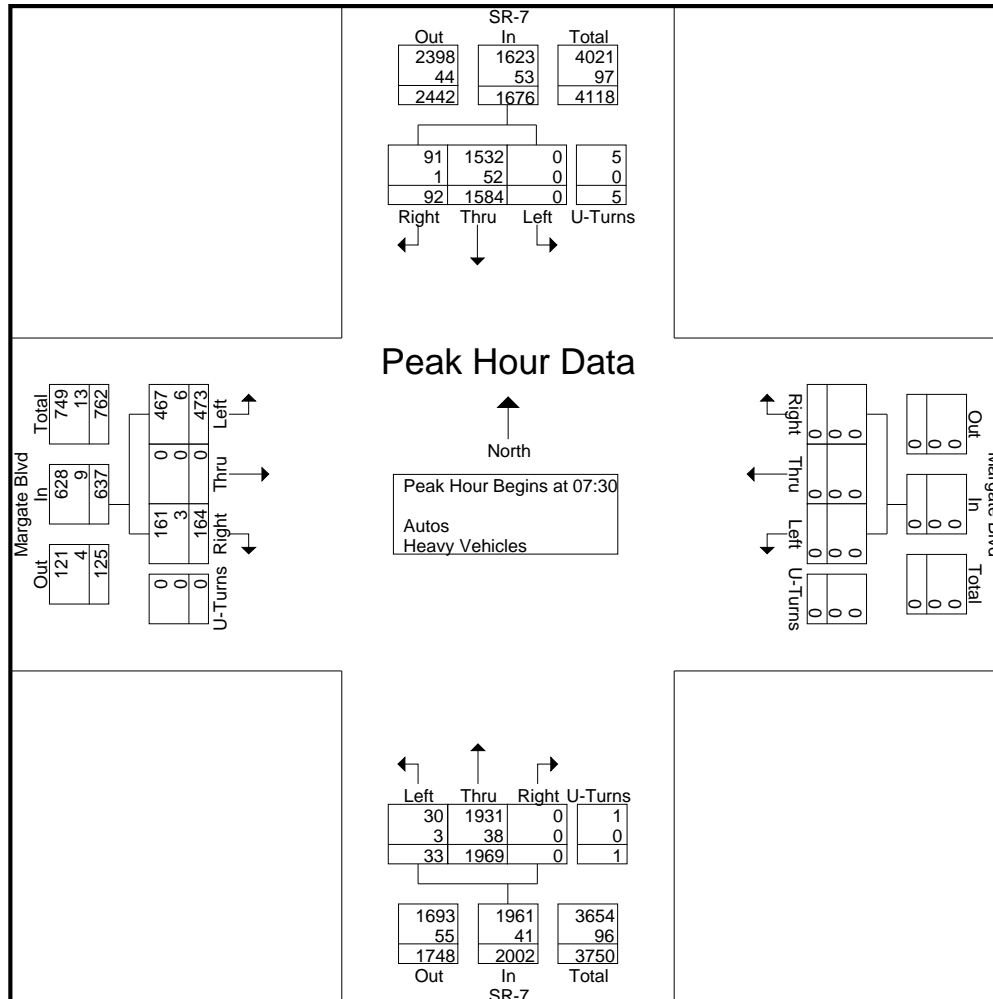

Traf Tech Engineering Inc.

File Name : 4-SR-7 & Margate Blvd

Site Code : 00000000

Start Date : 5/11/2022

Page No : 5

Start Time	SR-7 From North					Margate Blvd From East					SR-7 From South					Margate Blvd From West					Int. Total	
	Right	Thru	Left	U-Turns	App. Total	Right	Thru	Left	U-Turns	App. Total	Right	Thru	Left	U-Turns	App. Total	Right	Thru	Left	U-Turns	App. Total		
Peak Hour Analysis From 16:00 to 17:45 - Peak 1 of 1																						
Peak Hour for Entire Intersection Begins at 16:45																						
16:45	36	522	0	1	559	0	0	0	0	0	0	406	24	5	435	16	0	41	0	57	1051	
17:00	30	463	0	3	496	0	0	0	0	0	0	405	22	3	430	20	0	63	0	83	1009	
17:15	49	504	1	1	555	0	0	0	0	0	0	348	18	2	368	19	0	46	0	65	988	
17:30	32	507	0	6	545	0	0	0	0	0	0	427	21	2	450	14	0	40	0	54	1049	
Total Volume	147	1996	1	11	2155	0	0	0	0	0	0	1586	85	12	1683	69	0	190	0	259	4097	
% App. Total	6.8	92.6	0	0.5		0	0	0	0	0	0	94.2	5.1	0.7		26.6	0	73.4	0			
PHF	.750	.956	.250	.458	.964	.000	.000	.000	.000	.000	.000	.929	.885	.600	.935	.863	.000	.754	.000	.780	.975	
Autos	145	1975										1547										
% Autos	98.6	98.9	100	100	98.9	0	0	0	0	0	0	97.5	98.8	100	97.6	95.7	0	96.8	0	96.5	98.2	
Heavy Vehicles																						
% Heavy Vehicles	1.4	1.1	0	0	1.1	0	0	0	0	0	0	2.5	1.2	0	2.4	4.3	0	3.2	0	3.5	1.8	

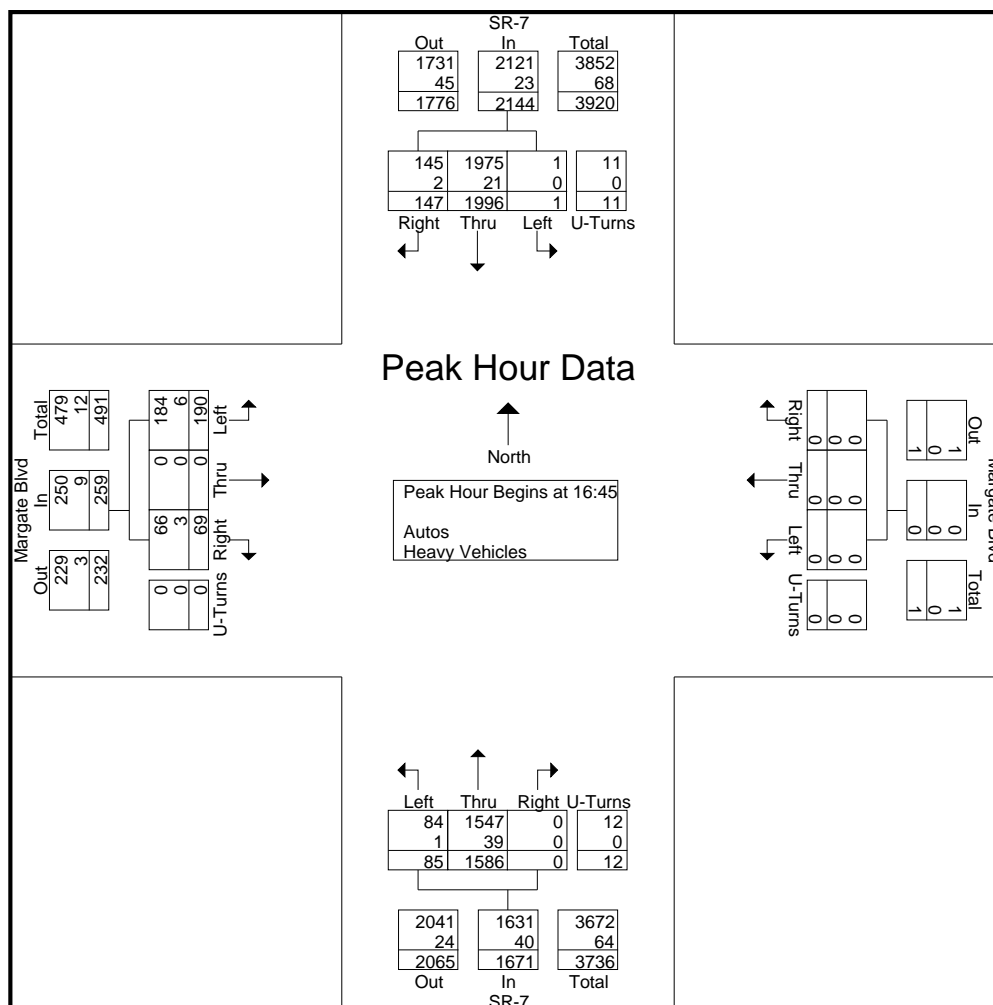

Traf Tech Engineering Inc.

File Name : 5-Riverside Dr & Atlantic Blvd

Site Code : 00000000

Start Date : 5/11/2022

Page No : 1

Groups Printed- Peds & Bikes

Start Time	Riverside Dr From North				Atlantic Blvd From East				Riverside Dr From South				Atlantic Blvd From West				Int. Total
	Bikes			Peds	Bikes			Peds	Bikes			Peds	Bikes			Peds	
*** BREAK ***																	
07:30	0	0	0	0	0	0	0	0	0	0	0	2	0	0	0	0	2
07:45	1	0	0	0	0	0	0	0	0	0	0	0	0	0	0	0	1
Total	1	0	0	0	0	0	0	0	0	0	0	2	0	0	0	0	3
08:00	1	0	0	0	0	0	0	0	0	0	0	0	0	0	0	0	1
08:15	1	0	0	0	0	0	0	0	0	0	0	0	0	0	0	0	1
08:30	0	0	0	0	0	0	0	0	0	0	0	1	0	0	0	0	1
08:45	0	0	0	10	0	0	0	0	0	0	0	2	0	1	0	3	16
Total	2	0	0	10	0	0	0	0	0	0	0	3	0	1	0	3	19
*** BREAK ***																	
16:00	0	0	0	14	0	0	0	0	0	0	0	8	0	0	0	11	33
*** BREAK ***																	
16:30	0	0	0	6	0	0	0	0	0	0	0	0	0	0	0	0	6
16:45	1	0	0	1	0	0	0	0	0	0	0	0	0	0	0	0	2
Total	1	0	0	21	0	0	0	0	0	0	0	8	0	0	0	11	41
*** BREAK ***																	
17:30	0	0	0	0	0	0	0	3	1	0	0	0	0	0	0	0	4
17:45	0	0	0	0	0	0	0	0	0	0	0	0	1	0	0	0	1
Total	0	0	0	0	0	0	0	3	1	0	0	0	1	0	0	0	5
Grand Total	4	0	0	31	0	0	0	3	1	0	0	13	1	1	0	14	68
Apprch %	11.4	0	0	88.6	0	0	0	100	7.1	0	0	92.9	6.2	6.2	0	87.5	
Total %	5.9	0	0	45.6	0	0	0	4.4	1.5	0	0	19.1	1.5	1.5	0	20.6	

Traf Tech Engineering Inc.

File Name : 5-Riverside Dr & Atlantic Blvd
 Site Code : 00000000
 Start Date : 5/11/2022
 Page No : 1

Groups Printed- Autos - Heavy Vehicles

Start Time	Riverside Dr From North					Atlantic Blvd From East					Riverside Dr From South					Atlantic Blvd From West					Int. Total
	Right	Thru	Left	U-Turns	App. Total	Right	Thru	Left	U-Turns	App. Total	Right	Thru	Left	U-Turns	App. Total	Right	Thru	Left	U-Turns	App. Total	
07:00	31	110	61	0	202	37	156	38	0	231	51	101	4	0	156	16	199	22	1	238	827
07:15	35	92	81	0	208	49	133	35	0	217	59	111	1	0	171	19	186	14	1	220	816
07:30	43	90	62	0	195	62	182	44	0	288	99	170	7	0	276	16	262	33	0	311	1070
07:45	44	114	81	0	239	65	175	50	0	290	94	146	7	0	247	20	203	20	0	243	1019
Total	153	406	285	0	844	213	646	167	0	1026	303	528	19	0	850	71	850	89	2	1012	3732
08:00	40	92	87	0	219	49	165	54	0	268	75	128	5	0	208	10	217	23	0	250	945
08:15	45	88	76	0	209	33	154	29	0	216	46	118	3	0	167	12	174	21	0	207	799
08:30	33	116	61	0	210	48	137	28	0	213	61	129	4	0	194	14	166	23	0	203	820
08:45	37	91	51	1	180	57	166	51	0	274	48	84	7	0	139	7	201	25	2	235	828
Total	155	387	275	1	818	187	622	162	0	971	230	459	19	0	708	43	758	92	2	895	3392
*** BREAK ***																					
16:00	43	114	63	2	222	70	280	60	0	410	55	166	12	2	235	22	219	33	0	274	1141
16:15	48	89	64	0	201	59	196	44	0	299	33	88	4	0	125	18	237	26	3	284	909
16:30	46	132	80	0	258	77	173	47	0	297	48	126	9	0	183	15	207	34	1	257	995
16:45	42	99	86	0	227	70	216	58	0	344	55	106	9	0	170	19	243	31	2	295	1036
Total	179	434	293	2	908	276	865	209	0	1350	191	486	34	2	713	74	906	124	6	1110	4081
17:00	40	114	77	1	232	84	197	67	0	348	60	147	15	0	222	17	266	27	0	310	1112
17:15	48	123	75	0	246	73	223	53	0	349	52	160	14	0	226	15	182	26	1	224	1045
17:30	36	111	71	0	218	76	228	55	0	359	54	142	10	0	206	17	251	54	1	323	1106
17:45	44	117	62	2	225	71	205	55	0	331	56	181	14	1	252	11	202	37	0	250	1058
Total	168	465	285	3	921	304	853	230	0	1387	222	630	53	1	906	60	901	144	2	1107	4321
Grand Total	655	1692	1138	6	3491	980	2986	768	0	4734	946	2103	125	3	3177	248	3415	449	12	4124	15526
Apprch %	18.8	48.5	32.6	0.2		20.7	63.1	16.2	0		29.8	66.2	3.9	0.1		6	82.8	10.9	0.3		
Total %	4.2	10.9	7.3	0	22.5	6.3	19.2	4.9	0	30.5	6.1	13.5	0.8	0	20.5	1.6	22	2.9	0.1	26.6	
Autos	637	1674	1131			2942					2080					3362					15324
% Autos	97.3	98.9	99.4	100	98.8	99.3	98.5	99.1	0	98.8	98.6	98.9	100	100	98.9	99.2	98.4	97.8	100	98.4	98.7
Heavy Vehicles																					
% Heavy Vehicles	2.7	1.1	0.6	0	1.2	0.7	1.5	0.9	0	1.2	1.4	1.1	0	0	1.1	0.8	1.6	2.2	0	1.6	1.3

Traf Tech Engineering Inc.

File Name : 5-Riverside Dr & Atlantic Blvd

Site Code : 00000000

Start Date : 5/11/2022

Page No : 2

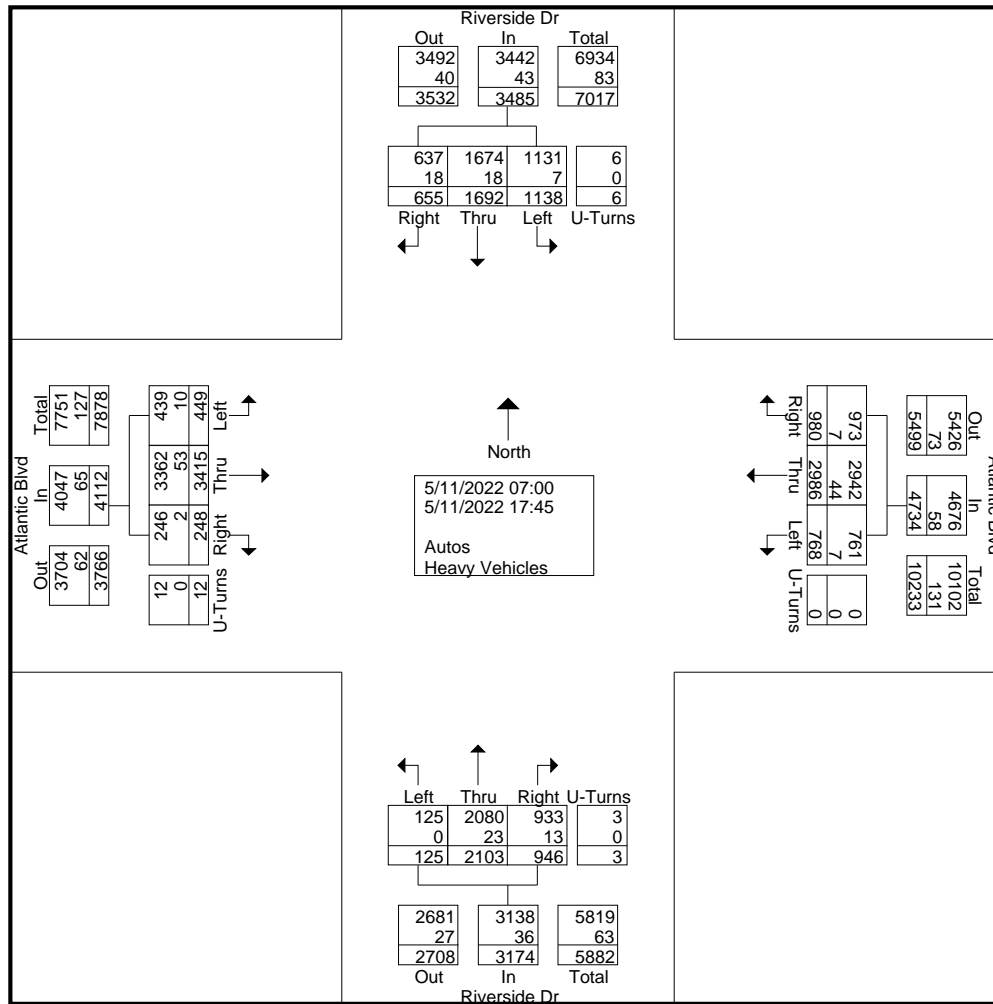

Traf Tech Engineering Inc.

File Name : 5-Riverside Dr & Atlantic Blvd
 Site Code : 00000000
 Start Date : 5/11/2022
 Page No : 3

Start Time	Riverside Dr From North					Atlantic Blvd From East					Riverside Dr From South					Atlantic Blvd From West					Int. Total
	Right	Thru	Left	U-Turns	App. Total	Right	Thru	Left	U-Turns	App. Total	Right	Thru	Left	U-Turns	App. Total	Right	Thru	Left	U-Turns	App. Total	
Peak Hour Analysis From 07:00 to 17:45 - Peak 1 of 1																					
Peak Hour for Entire Intersection Begins at 17:00																					
17:00	40	114	77	1	232	84	197	67	0	348	60	147	15	0	222	17	266	27	0	310	1112
17:15	48	123	75	0	246	73	223	53	0	349	52	160	14	0	226	15	182	26	1	224	1045
17:30	36	111	71	0	218	76	228	55	0	359	54	142	10	0	206	17	251	54	1	323	1106
17:45	44	117	62	2	225	71	205	55	0	331	56	181	14	1	252	11	202	37	0	250	1058
Total Volume	168	465	285	3	921	304	853	230	0	1387	222	630	53	1	906	60	901	144	2	1107	4321
% App. Total	18.2	50.5	30.9	0.3		21.9	61.5	16.6	0		24.5	69.5	5.8	0.1		5.4	81.4	13	0.2		
PHF	.875	.945	.925	.375	.936	.905	.935	.858	.000	.966	.925	.870	.883	.250	.899	.882	.847	.667	.500	.857	.971
Autos	166	462	283	3	914	302	848	229	0	1379	221	623	53	1	898	59	889	141	2	1091	4282
% Autos	98.8	99.4	99.3	100	99.2	99.3	99.4	99.6	0	99.4	99.5	98.9	100	100	99.1	98.3	98.7	97.9	100	98.6	99.1
Heavy Vehicles																					
% Heavy Vehicles	1.2	0.6	0.7	0	0.8	0.7	0.6	0.4	0	0.6	0.5	1.1	0	0	0.9	1.7	1.3	2.1	0	1.4	0.9

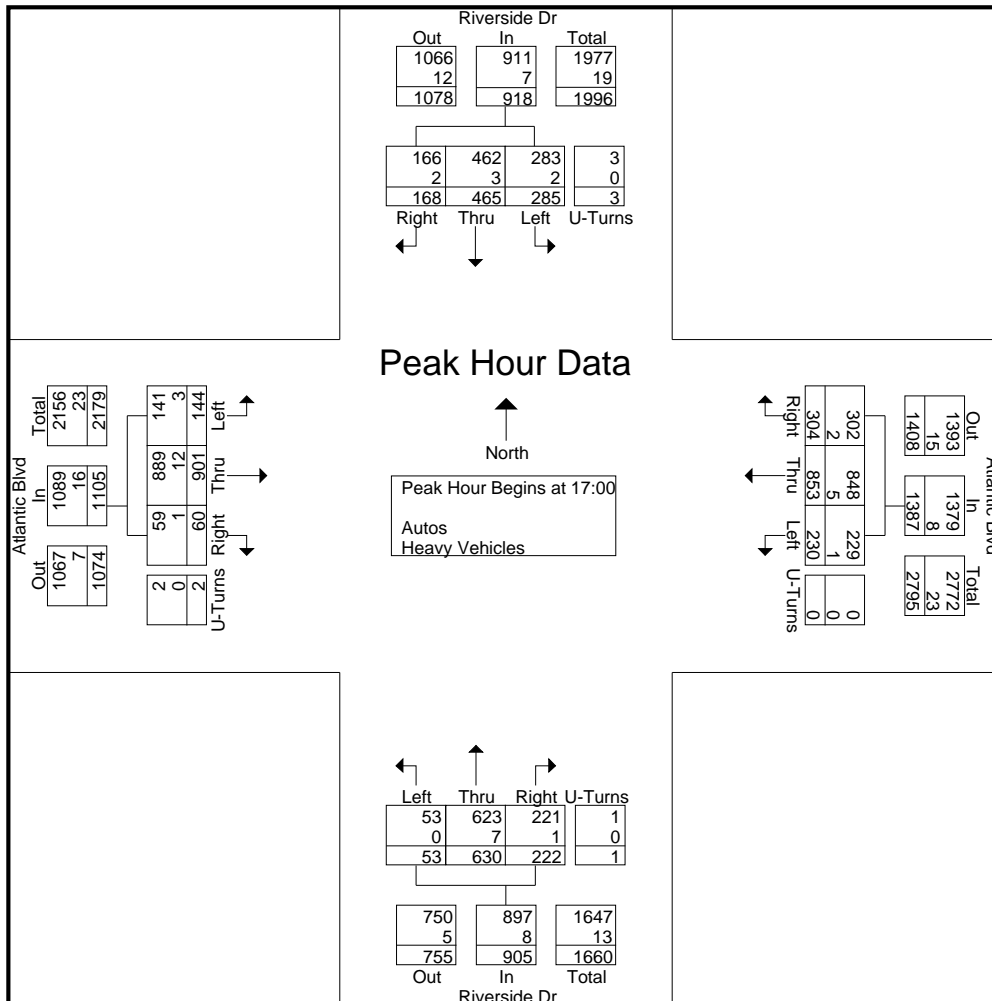

Traf Tech Engineering Inc.

File Name : 5-Riverside Dr & Atlantic Blvd
 Site Code : 00000000
 Start Date : 5/11/2022
 Page No : 4

Start Time	Riverside Dr From North					Atlantic Blvd From East					Riverside Dr From South					Atlantic Blvd From West					Int. Total
	Right	Thru	Left	U-Turns	App. Total	Right	Thru	Left	U-Turns	App. Total	Right	Thru	Left	U-Turns	App. Total	Right	Thru	Left	U-Turns	App. Total	
Peak Hour Analysis From 07:00 to 08:45 - Peak 1 of 1																					
Peak Hour for Entire Intersection Begins at 07:15																					
07:15	35	92	81	0	208	49	133	35	0	217	59	111	1	0	171	19	186	14	1	220	816
07:30	43	90	62	0	195	62	182	44	0	288	99	170	7	0	276	16	262	33	0	311	1070
07:45	44	114	81	0	239	65	175	50	0	290	94	146	7	0	247	20	203	20	0	243	1019
08:00	40	92	87	0	219	49	165	54	0	268	75	128	5	0	208	10	217	23	0	250	945
Total Volume	162	388	311	0	861	225	655	183	0	1063	327	555	20	0	902	65	868	90	1	1024	3850
% App. Total	18.8	45.1	36.1	0		21.2	61.6	17.2	0		36.3	61.5	2.2	0		6.3	84.8	8.8	0.1		
PHF	.920	.851	.894	.000	.901	.865	.900	.847	.000	.916	.826	.816	.714	.000	.817	.813	.828	.682	.250	.823	.900
Autos	157	384	310	0	851	223	640	181	0	1044	322	553	20	0	895	65	862	88	1	1016	3806
% Autos	96.9	99.0	99.7	0	98.8	99.1	97.7	98.9	0	98.2	98.5	99.6	100	0	99.2	100	99.3	97.8	100	99.2	98.9
Heavy Vehicles																					
% Heavy Vehicles	3.1	1.0	0.3	0	1.2	0.9	2.3	1.1	0	1.8	1.5	0.4	0	0.8	0	0.7	2.2	0	0.8	1.1	

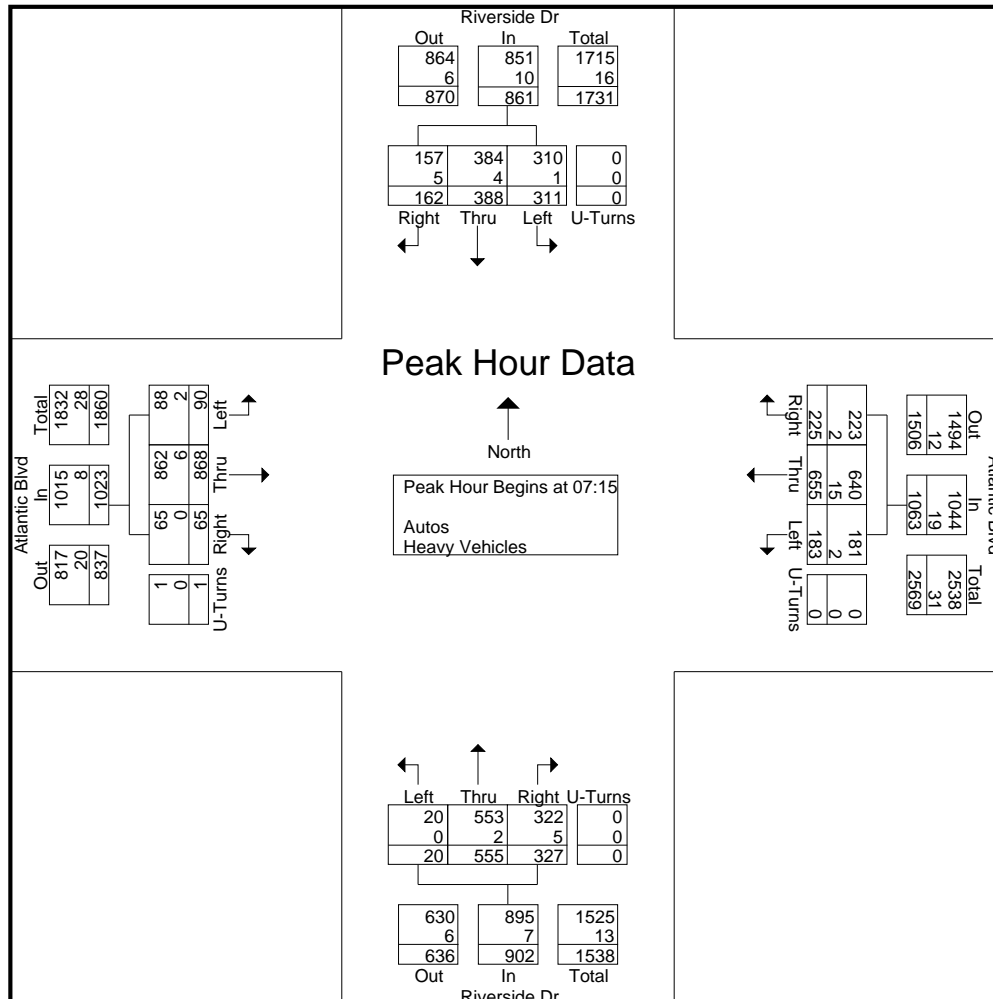

Traf Tech Engineering Inc.

File Name : 5-Riverside Dr & Atlantic Blvd
 Site Code : 00000000
 Start Date : 5/11/2022
 Page No : 5

Start Time	Riverside Dr From North					Atlantic Blvd From East					Riverside Dr From South					Atlantic Blvd From West					Int. Total
	Right	Thru	Left	U-Turns	App. Total	Right	Thru	Left	U-Turns	App. Total	Right	Thru	Left	U-Turns	App. Total	Right	Thru	Left	U-Turns	App. Total	
Peak Hour Analysis From 16:00 to 17:45 - Peak 1 of 1																					
Peak Hour for Entire Intersection Begins at 17:00																					
17:00	40	114	77	1	232	84	197	67	0	348	60	147	15	0	222	17	266	27	0	310	1112
17:15	48	123	75	0	246	73	223	53	0	349	52	160	14	0	226	15	182	26	1	224	1045
17:30	36	111	71	0	218	76	228	55	0	359	54	142	10	0	206	17	251	54	1	323	1106
17:45	44	117	62	2	225	71	205	55	0	331	56	181	14	1	252	11	202	37	0	250	1058
Total Volume	168	465	285	3	921	304	853	230	0	1387	222	630	53	1	906	60	901	144	2	1107	4321
% App. Total	18.2	50.5	30.9	0.3		21.9	61.5	16.6	0		24.5	69.5	5.8	0.1		5.4	81.4	13	0.2		
PHF	.875	.945	.925	.375	.936	.905	.935	.858	.000	.966	.925	.870	.883	.250	.899	.882	.847	.667	.500	.857	.971
Autos	166	462	283	3	914	302	848	229	0	1379	221	623	53	1	898	59	889	141	2	1091	4282
% Autos	98.8	99.4	99.3	100	99.2	99.3	99.4	99.6	0	99.4	99.5	98.9	100	100	99.1	98.3	98.7	97.9	100	98.6	99.1
Heavy Vehicles																					
% Heavy Vehicles	1.2	0.6	0.7	0	0.8	0.7	0.6	0.4	0	0.6	0.5	1.1	0	0.9	1.7	1.3	2.1	0	1.4	0.9	

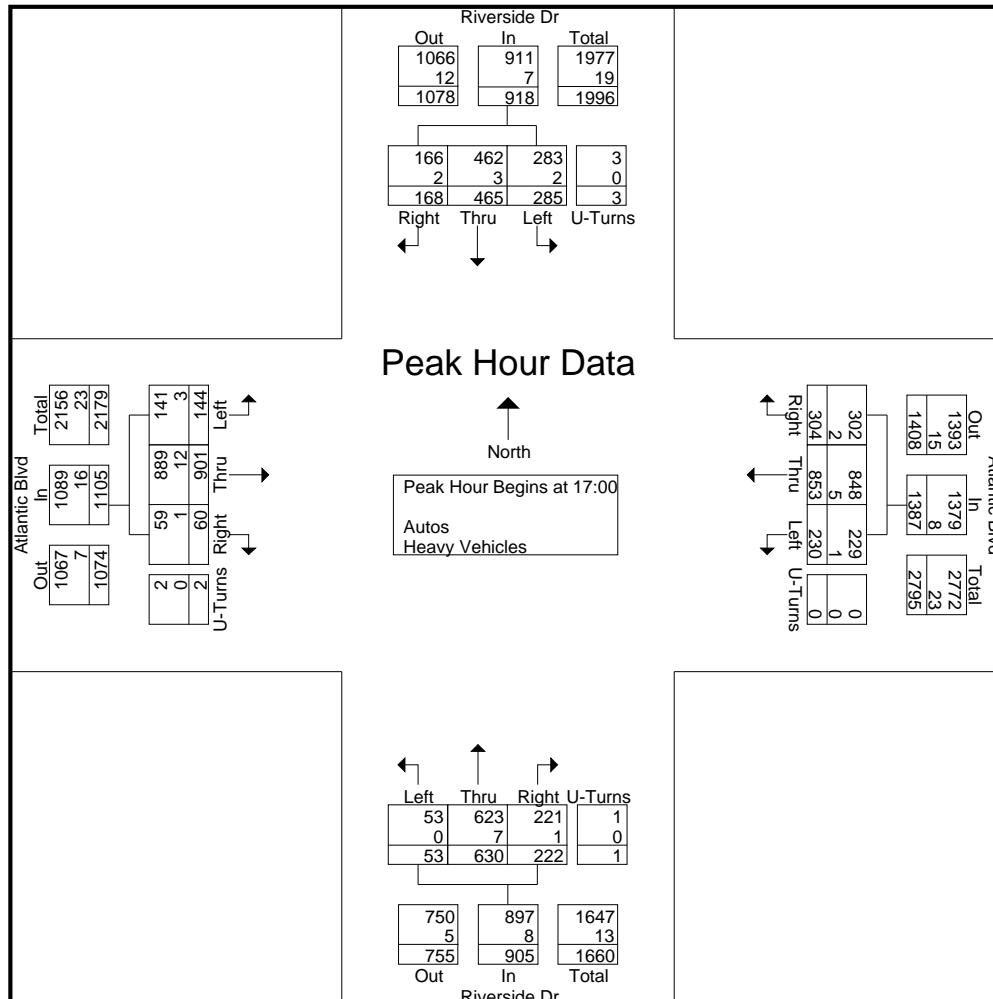

Traf Tech Engineering Inc.

File Name : 6-Ramblewood Dr & Atlantic Blvd

Site Code : 00000000

Start Date : 5/11/2022

Page No : 1

Groups Printed- Peds & Bikes

Start Time	Ramblewood Dr From North				Atlantic Blvd From East				Ramblewood Dr From South				Atlantic Blvd From West				Int. Total
	Bikes			Peds	Bikes			Peds	Bikes			Peds	Bikes			Peds	
*** BREAK ***																	
07:15	0	0	0	0	0	0	0	0	1	0	0	0	0	0	0	0	1
07:30	0	0	0	0	1	0	0	0	0	0	0	1	0	0	0	1	3
07:45	0	0	0	0	0	0	0	0	0	0	0	0	0	0	0	1	1
Total	0	0	0	0	1	0	0	0	1	0	0	1	0	0	0	2	5
*** BREAK ***																	
08:15	0	0	0	0	0	0	0	0	0	0	0	0	0	0	0	2	2
08:30	0	0	0	0	0	0	0	1	0	0	0	0	0	0	0	2	3
08:45	0	0	0	0	2	0	0	0	0	0	0	0	0	0	0	10	12
Total	0	0	0	0	2	0	0	1	0	0	0	0	0	0	0	14	17
*** BREAK ***																	
16:00	0	0	0	0	0	0	0	0	0	0	0	3	0	0	0	0	3
16:15	0	0	0	1	0	0	0	1	0	0	0	0	0	0	0	2	4
16:30	0	0	0	0	0	0	0	0	0	0	0	0	0	0	0	1	1
16:45	0	0	0	0	0	0	0	0	0	0	0	0	0	0	0	2	2
Total	0	0	0	1	0	0	0	1	0	0	0	3	0	0	0	5	10
*** BREAK ***																	
17:15	2	0	0	2	0	0	0	1	0	0	0	0	0	0	0	0	5
*** BREAK ***																	
Total	2	0	0	2	0	0	0	1	0	0	0	0	0	0	0	0	5
Grand Total	2	0	0	3	3	0	0	3	1	0	0	4	0	0	0	21	37
Apprch %	40	0	0	60	50	0	0	50	20	0	0	80	0	0	0	100	
Total %	5.4	0	0	8.1	8.1	0	0	8.1	2.7	0	0	10.8	0	0	0	56.8	

Traf Tech Engineering Inc.

File Name : 6-Ramblewood Dr & Atlantic Blvd

Site Code : 00000000

Start Date : 5/11/2022

Page No : 1

Groups Printed- Autos - Heavy Vehicles

Start Time	Ramblewood Dr From North					Atlantic Blvd From East					Ramblewood Dr From South					Atlantic Blvd From West					Int. Total
	Right	Thru	Left	U-Turns	App. Total	Right	Thru	Left	U-Turns	App. Total	Right	Thru	Left	U-Turns	App. Total	Right	Thru	Left	U-Turns	App. Total	
07:00	13	0	33	0	46	8	225	3	3	239	10	1	7	0	18	2	303	5	0	310	613
07:15	10	2	46	2	60	18	245	4	2	269	15	5	10	1	31	4	298	8	0	310	670
07:30	10	2	45	0	57	20	197	1	2	220	20	10	6	0	36	1	367	15	0	383	696
07:45	22	4	31	0	57	35	308	3	3	349	11	2	5	0	18	5	371	14	0	390	814
Total	55	8	155	2	220	81	975	11	10	1077	56	18	28	1	103	12	1339	42	0	1393	2793
08:00	15	2	42	2	61	29	231	9	2	271	11	3	7	0	21	4	363	16	0	383	736
08:15	20	2	31	1	54	21	219	2	5	247	9	6	8	0	23	2	273	8	0	283	607
08:30	13	0	27	1	41	15	245	4	7	271	13	2	4	0	19	3	277	8	4	292	623
08:45	34	1	41	0	76	7	231	8	11	257	4	2	10	1	17	4	244	9	14	271	621
Total	82	5	141	4	232	72	926	23	25	1046	37	13	29	1	80	13	1157	41	18	1229	2587
*** BREAK ***																					
16:00	4	1	17	0	22	15	244	2	2	263	1	3	2	0	6	6	227	3	0	236	527
16:15	11	4	29	0	44	37	335	15	10	397	4	0	9	0	13	8	334	5	1	348	802
16:30	9	0	12	2	23	26	339	3	8	376	9	4	6	0	19	11	334	6	0	351	769
16:45	17	4	26	1	48	38	400	9	10	457	8	1	7	0	16	11	331	19	0	361	882
Total	41	9	84	3	137	116	1318	29	30	1493	22	8	24	0	54	36	1226	33	1	1296	2980
17:00	17	3	38	0	58	35	341	16	12	404	11	2	6	0	19	8	316	9	0	333	814
17:15	9	4	20	0	33	35	429	16	6	486	2	1	6	0	9	6	361	9	1	377	905
17:30	8	4	21	0	33	36	384	11	9	440	1	4	1	0	6	9	315	7	1	332	811
17:45	5	5	11	0	21	34	425	7	11	477	7	0	8	1	16	8	323	10	0	341	855
Total	39	16	90	0	145	140	1579	50	38	1807	21	7	21	1	50	31	1315	35	2	1383	3385
Grand Total	217	38	470	9	734	409	4798	113	103	5423	136	46	102	3	287	92	5037	151	21	5301	11745
Apprch %	29.6	5.2	64	1.2		7.5	88.5	2.1	1.9		47.4	16	35.5	1		1.7	95	2.8	0.4		
Total %	1.8	0.3	4	0.1	6.2	3.5	40.9	1	0.9	46.2	1.2	0.4	0.9	0	2.4	0.8	42.9	1.3	0.2	45.1	
Autos	215	36	466	9	726	403	4719			4970							4970				11569
% Autos	99.1	94.7	99.1	100	98.9	98.5	98.4	98.2	99	98.4	97.8	97.8	98	100	97.9	98.9	98.7	96	100	98.6	98.5
Heavy Vehicles																					
% Heavy Vehicles	0.9	5.3	0.9	0	1.1	1.5	1.6	1.8	1	1.6	2.2	2.2	2	0	2.1	1.1	1.3	4	0	1.4	1.5

Traf Tech Engineering Inc.

File Name : 6-Ramblewood Dr & Atlantic Blvd

Site Code : 00000000

Start Date : 5/11/2022

Page No : 2

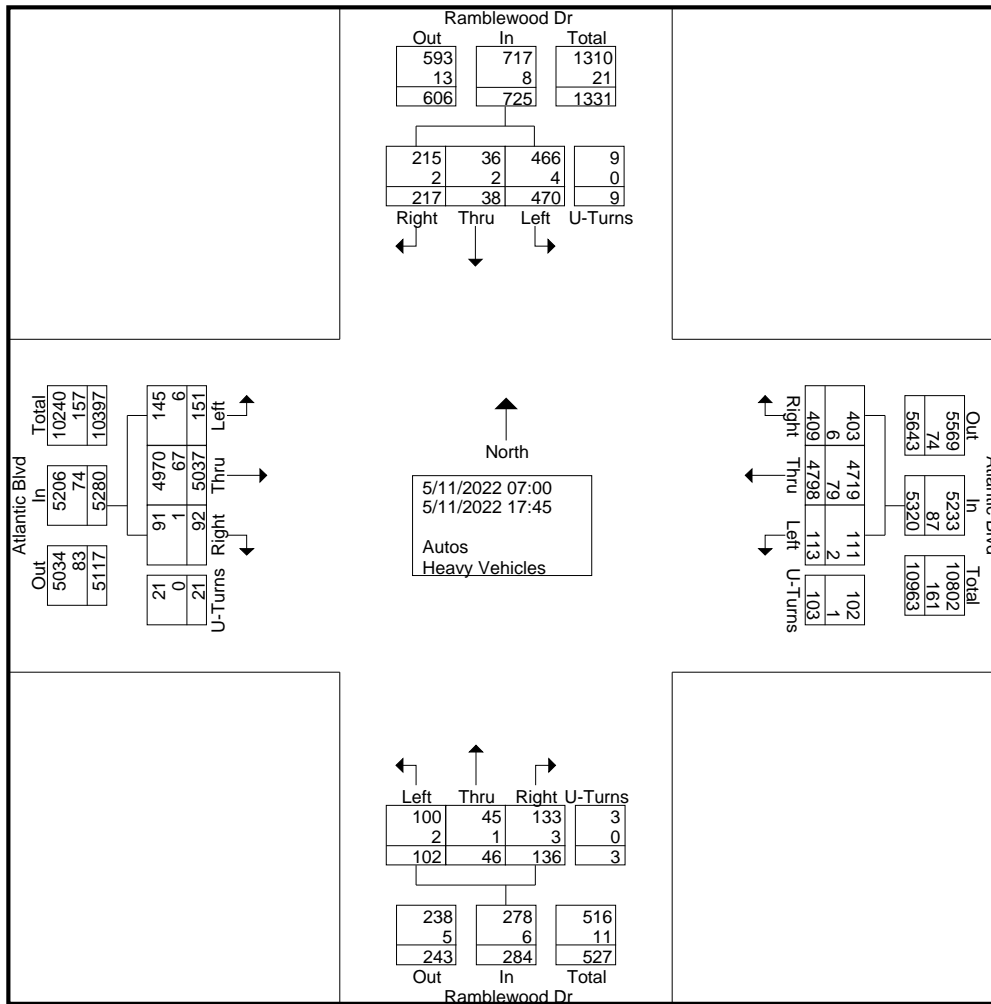

Traf Tech Engineering Inc.

File Name : 6-Ramblewood Dr & Atlantic Blvd
 Site Code : 00000000
 Start Date : 5/11/2022
 Page No : 3

Start Time	Ramblewood Dr From North					Atlantic Blvd From East					Ramblewood Dr From South					Atlantic Blvd From West					Int. Total
	Right	Thru	Left	U-Turns	App. Total	Right	Thru	Left	U-Turns	App. Total	Right	Thru	Left	U-Turns	App. Total	Right	Thru	Left	U-Turns	App. Total	
Peak Hour Analysis From 07:00 to 17:45 - Peak 1 of 1																					
Peak Hour for Entire Intersection Begins at 16:45																					
16:45	17	4	26	1	48	38	400	9	10	457	8	1	7	0	16	11	331	19	0	361	882
17:00	17	3	38	0	58	35	341	16	12	404	11	2	6	0	19	8	316	9	0	333	814
17:15	9	4	20	0	33	35	429	16	6	486	2	1	6	0	9	6	361	9	1	377	905
17:30	8	4	21	0	33	36	384	11	9	440	1	4	1	0	6	9	315	7	1	332	811
Total Volume	51	15	105	1	172	144	1554	52	37	1787	22	8	20	0	50	34	1323	44	2	1403	3412
% App. Total	29.7	8.7	61	0.6		8.1	87	2.9	2.1		4.4	16	40	0		2.4	94.3	3.1	0.1		
PHF	.750	.938	.691	.250	.741	.947	.906	.813	.771	.919	.500	.500	.714	.000	.658	.773	.916	.579	.500	.930	.943
Autos	51	15	104	1	171	144	1544									1303					
% Autos	100	100	99.0	100	99.4	100	99.4	100	100	99.4	95.5	87.5	100	0	96.0	100	98.5	97.7	100	98.5	99.0
Heavy Vehicles																					
% Heavy Vehicles	0	0	1.0	0	0.6	0	0.6	0	0	0.6	4.5	12.5	0	0	4.0	0	1.5	2.3	0	1.5	1.0

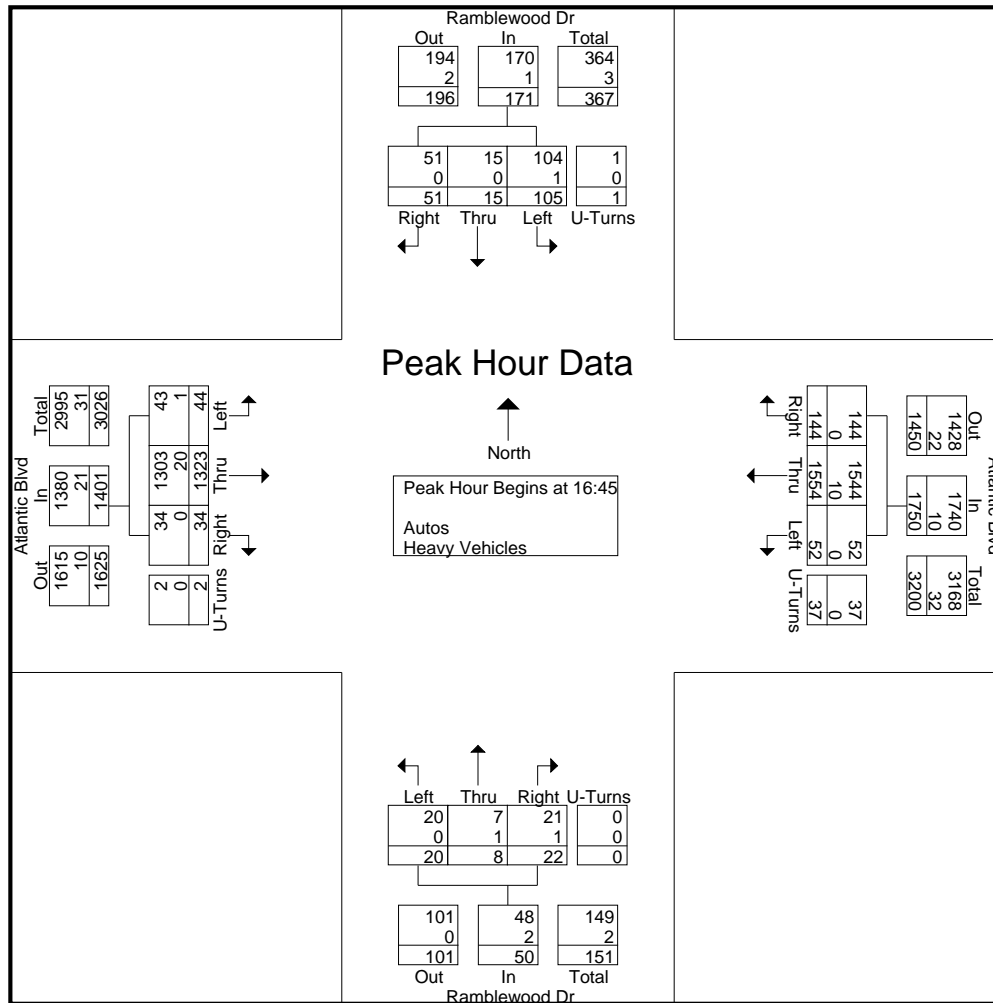

Traf Tech Engineering Inc.

File Name : 6-Ramblewood Dr & Atlantic Blvd
 Site Code : 00000000
 Start Date : 5/11/2022
 Page No : 4

Start Time	Ramblewood Dr From North					Atlantic Blvd From East					Ramblewood Dr From South					Atlantic Blvd From West					Int. Total
	Right	Thru	Left	U-Turns	App. Total	Right	Thru	Left	U-Turns	App. Total	Right	Thru	Left	U-Turns	App. Total	Right	Thru	Left	U-Turns	App. Total	
Peak Hour Analysis From 07:00 to 08:45 - Peak 1 of 1																					
Peak Hour for Entire Intersection Begins at 07:15																					
07:15	10	2	46	2	60	18	245	4	2	269	15	5	10	1	31	4	298	8	0	310	670
07:30	10	2	45	0	57	20	197	1	2	220	20	10	6	0	36	1	367	15	0	383	696
07:45	22	4	31	0	57	35	308	3	3	349	11	2	5	0	18	5	371	14	0	390	814
08:00	15	2	42	2	61	29	231	9	2	271	11	3	7	0	21	4	363	16	0	383	736
Total Volume	57	10	164	4	235	102	981	17	9	1109	57	20	28	1	106	14	1399	53	0	1466	2916
% App. Total	24.3	4.3	69.8	1.7		9.2	88.5	1.5	0.8		53.8	18.9	26.4	0.9		1	95.4	3.6	0		
PHF	.648	.625	.891	.500	.963	.729	.796	.472	.750	.794	.713	.500	.700	.250	.736	.700	.943	.828	.000	.940	.896
Autos	56	9	164	4	233	100	949	17	8	1074	56	20	28	1	105	14	1383				
% Autos	98.2	90.0	100	100	99.1	98.0	96.7	100	88.9	96.8	98.2	100	100	100	99.1	100	98.9	96.2	0	98.8	98.1
Heavy Vehicles																					
% Heavy Vehicles	1.8	10.0	0	0	0.9	2.0	3.3	0	11.1	3.2	1.8	0	0	0.9	0	1.1	3.8	0	1.2	1.9	

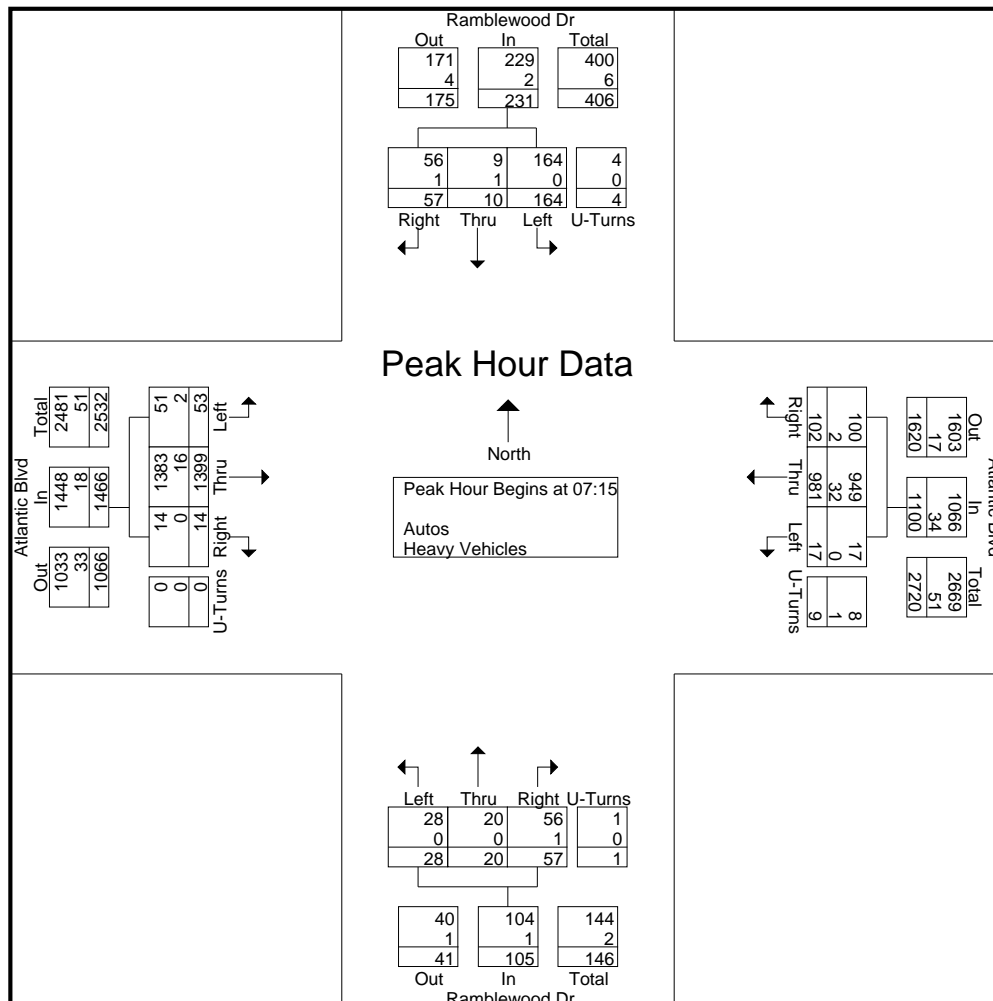

Traf Tech Engineering Inc.

File Name : 6-Ramblewood Dr & Atlantic Blvd
 Site Code : 00000000
 Start Date : 5/11/2022
 Page No : 5

Start Time	Ramblewood Dr From North					Atlantic Blvd From East					Ramblewood Dr From South					Atlantic Blvd From West					Int. Total
	Right	Thru	Left	U-Turns	App. Total	Right	Thru	Left	U-Turns	App. Total	Right	Thru	Left	U-Turns	App. Total	Right	Thru	Left	U-Turns	App. Total	
Peak Hour Analysis From 16:00 to 17:45 - Peak 1 of 1																					
Peak Hour for Entire Intersection Begins at 16:45																					
16:45	17	4	26	1	48	38	400	9	10	457	8	1	7	0	16	11	331	19	0	361	882
17:00	17	3	38	0	58	35	341	16	12	404	11	2	6	0	19	8	316	9	0	333	814
17:15	9	4	20	0	33	35	429	16	6	486	2	1	6	0	9	6	361	9	1	377	905
17:30	8	4	21	0	33	36	384	11	9	440	1	4	1	0	6	9	315	7	1	332	811
Total Volume	51	15	105	1	172	144	1554	52	37	1787	22	8	20	0	50	34	1323	44	2	1403	3412
% App. Total	29.7	8.7	61	0.6		8.1	87	2.9	2.1		4.4	16	40	0		2.4	94.3	3.1	0.1		
PHF	.750	.938	.691	.250	.741	.947	.906	.813	.771	.919	.500	.500	.714	.000	.658	.773	.916	.579	.500	.930	.943
Autos	51	15	104	1	171	144	1544										1303				
% Autos	100	100	99.0	100	99.4	100	99.4	100	100	99.4	95.5	87.5	100	0	96.0	100	98.5	97.7	100	98.5	99.0
Heavy Vehicles	0	0	1.0	0	0.6	0	0.6	0	0	0.6	4.5	12.5	0	0	4.0	0	1.5	2.3	0	1.5	1.0

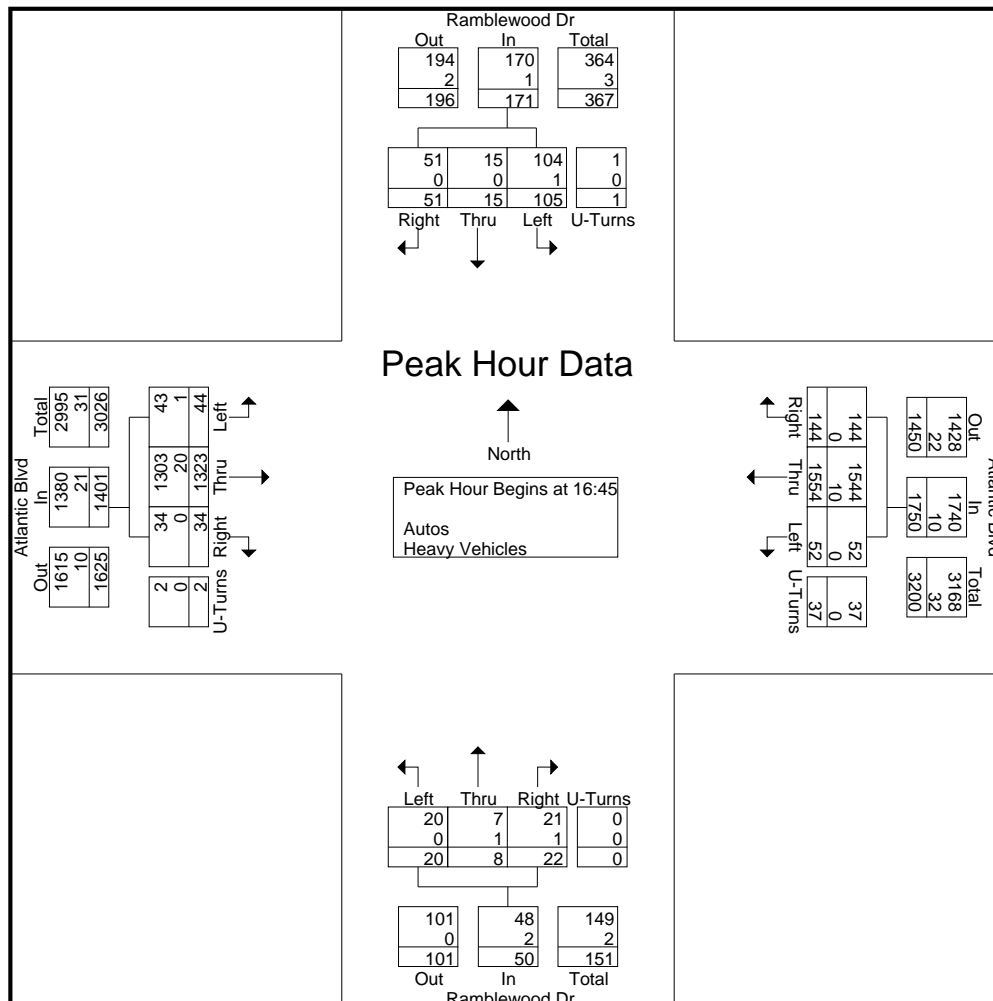

Traf Tech Engineering Inc.

File Name : 7-NW 76th Ave & Atlantic Blvd

Site Code : 00000000

Start Date : 5/11/2022

Page No : 1

Groups Printed- Peds & Bikes

Start Time	NW 76th Ave From North				Atlantic Blvd From East				NW 76th Ave From South				Atlantic Blvd From West				Int. Total
	Bikes			Peds	Bikes			Peds	Bikes			Peds	Bikes			Peds	
07:00	0	0	0	1	0	0	0	0	0	0	0	0	0	0	0	0	1
07:15	0	0	0	1	1	0	0	2	0	0	0	0	0	0	0	0	4
07:30	0	0	0	0	0	0	0	1	0	0	0	1	0	0	0	2	4
07:45	0	0	0	0	0	0	0	0	0	0	0	1	1	0	0	0	2
Total	0	0	0	2	1	0	0	3	0	0	0	2	1	0	0	2	11
08:00	0	0	0	0	0	0	0	0	0	0	0	1	0	0	0	0	1
08:15	0	0	0	2	0	0	0	0	0	0	0	0	0	0	0	0	2
08:30	0	0	0	2	0	0	0	0	1	0	0	0	0	0	0	0	3
08:45	0	0	1	0	0	0	0	0	0	0	0	0	0	0	0	0	1
Total	0	0	1	4	0	0	0	0	1	0	0	1	0	0	0	0	7
*** BREAK ***																	
16:00	0	0	0	0	1	0	0	1	0	0	0	0	0	0	0	0	2
16:15	1	0	0	0	1	0	0	1	1	0	0	0	0	0	0	0	4
16:30	0	0	0	0	0	0	0	1	0	0	0	0	0	0	0	0	1
16:45	0	0	0	0	0	0	0	0	1	0	0	0	0	0	0	0	1
Total	1	0	0	0	2	0	0	3	2	0	0	0	0	0	0	0	8
17:00	0	0	0	0	0	0	0	2	0	0	0	0	0	0	0	0	2
17:15	0	0	0	1	0	0	0	2	0	0	0	0	0	0	0	1	4
17:30	0	0	0	0	0	0	0	0	0	0	0	1	0	0	0	0	1
17:45	0	0	0	1	0	0	0	1	0	0	0	0	0	0	0	0	2
Total	0	0	0	2	0	0	0	5	0	0	0	1	0	0	0	1	9
Grand Total	1	0	1	8	3	0	0	11	3	0	0	4	1	0	0	3	35
Apprch %	10	0	10	80	21.4	0	0	78.6	42.9	0	0	57.1	25	0	0	75	
Total %	2.9	0	2.9	22.9	8.6	0	0	31.4	8.6	0	0	11.4	2.9	0	0	8.6	

Traf Tech Engineering Inc.

File Name : 7-NW 76th Ave & Atlantic Blvd
 Site Code : 00000000
 Start Date : 5/11/2022
 Page No : 1

Groups Printed- Autos - Heavy Vehicles

Start Time	NW 76th Ave From North					Atlantic Blvd From East					NW 76th Ave From South					Atlantic Blvd From West					Int. Total
	Right	Thru	Left	U-Turns	App. Total	Right	Thru	Left	U-Turns	App. Total	Right	Thru	Left	U-Turns	App. Total	Right	Thru	Left	U-Turns	App. Total	
07:00	28	3	21	0	52	7	193	0	0	200	2	0	2	0	4	3	367	9	0	379	635
07:15	29	3	31	0	63	10	200	0	1	211	4	2	8	0	14	11	410	8	0	429	717
07:30	35	6	13	0	54	10	216	0	0	226	5	3	8	0	16	18	423	10	0	451	747
07:45	37	4	15	0	56	14	261	0	0	275	4	5	10	0	19	17	395	16	2	430	780
Total	129	16	80	0	225	41	870	0	1	912	15	10	28	0	53	49	1595	43	2	1689	2879
08:00	40	9	18	0	67	18	220	0	4	242	4	2	5	0	11	4	407	19	0	430	750
08:15	24	2	24	0	50	18	229	0	1	248	2	1	6	0	9	2	319	9	1	331	638
08:30	31	2	25	0	58	18	226	0	1	245	3	4	7	0	14	7	323	14	1	345	662
08:45	44	3	17	0	64	16	235	0	2	253	5	2	9	0	16	10	287	9	1	307	640
Total	139	16	84	0	239	70	910	0	8	988	14	9	27	0	50	23	1336	51	3	1413	2690
*** BREAK ***																					
16:00	42	2	9	0	53	26	333	1	1	361	4	4	4	0	12	9	314	21	1	345	771
16:15	21	4	11	0	36	27	396	1	1	425	2	1	4	0	7	11	378	24	0	413	881
16:30	29	5	15	0	49	27	316	1	2	346	4	0	4	0	8	8	320	36	0	364	767
16:45	32	1	15	0	48	30	410	1	0	441	2	0	15	0	17	6	331	25	0	362	868
Total	124	12	50	0	186	110	1455	4	4	1573	12	5	27	0	44	34	1343	106	1	1484	3287
17:00	17	0	13	0	30	15	404	1	2	422	5	1	2	0	8	7	386	31	0	424	884
17:15	38	2	18	0	58	29	439	0	1	469	4	5	10	0	19	8	320	32	1	361	907
17:30	46	3	14	0	63	29	443	1	0	473	1	3	3	0	7	14	333	23	0	370	913
17:45	38	5	17	0	60	33	380	0	0	413	0	1	9	0	10	18	311	35	2	366	849
Total	139	10	62	0	211	106	1666	2	3	1777	10	10	24	0	44	47	1350	121	3	1521	3553
Grand Total	531	54	276	0	861	327	4901	6	16	5250	51	34	106	0	191	153	5624	321	9	6107	12409
Apprch %	61.7	6.3	32.1	0		6.2	93.4	0.1	0.3		26.7	17.8	55.5	0		2.5	92.1	5.3	0.1		
Total %	4.3	0.4	2.2	0	6.9	2.6	39.5	0	0.1	42.3	0.4	0.3	0.9	0	1.5	1.2	45.3	2.6	0.1	49.2	
Autos	529	53	270	0	852	322	4814									5548					12223
% Autos	99.6	98.1	97.8	0	99	98.5	98.2	100	87.5	98.2	98	97.1	100	0	99	99.3	98.6	98.8	100	98.7	98.5
Heavy Vehicles																					
% Heavy Vehicles	0.4	1.9	2.2	0	1	1.5	1.8	0	12.5	1.8	2	2.9	0	0	1	0.7	1.4	1.2	0	1.3	1.5

Traf Tech Engineering Inc.

File Name : 7-NW 76th Ave & Atlantic Blvd
 Site Code : 00000000
 Start Date : 5/11/2022
 Page No : 2

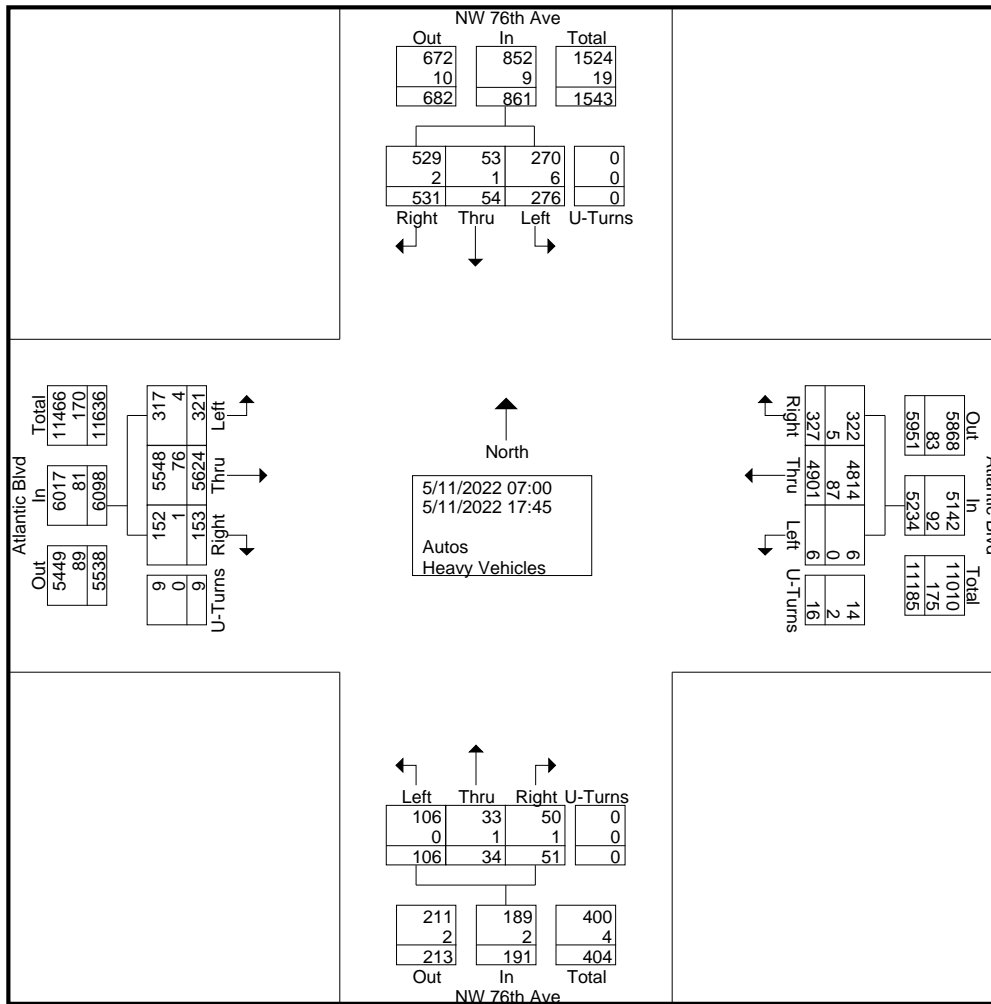

Traf Tech Engineering Inc.

File Name : 7-NW 76th Ave & Atlantic Blvd
 Site Code : 00000000
 Start Date : 5/11/2022
 Page No : 3

Start Time	NW 76th Ave From North					Atlantic Blvd From East					NW 76th Ave From South					Atlantic Blvd From West					Int. Total
	Right	Thru	Left	U-Turns	App. Total	Right	Thru	Left	U-Turns	App. Total	Right	Thru	Left	U-Turns	App. Total	Right	Thru	Left	U-Turns	App. Total	
Peak Hour Analysis From 07:00 to 17:45 - Peak 1 of 1																					
Peak Hour for Entire Intersection Begins at 16:45																					
16:45	32	1	15	0	48	30	410	1	0	441	2	0	15	0	17	6	331	25	0	362	868
17:00	17	0	13	0	30	15	404	1	2	422	5	1	2	0	8	7	386	31	0	424	884
17:15	38	2	18	0	58	29	439	0	1	469	4	5	10	0	19	8	320	32	1	361	907
17:30	46	3	14	0	63	29	443	1	0	473	1	3	3	0	7	14	333	23	0	370	913
Total Volume	133	6	60	0	199	103	1696	3	3	1805	12	9	30	0	51	35	1370	111	1	1517	3572
% App. Total	66.8	3	30.2	0		5.7	94	0.2	0.2		23.5	17.6	58.8	0		2.3	90.3	7.3	0.1		
PHF	.723	.500	.833	.000	.790	.858	.957	.750	.375	.954	.600	.450	.500	.000	.671	.625	.887	.867	.250	.894	.978
Autos	133	6	60	0	199	103	1688									1343					
% Autos	100	100	100	0	100	100	99.5	100	100	99.6	100	88.9	100	0	98.0	97.1	98.0	100	100	98.2	99.0
Heavy Vehicles																					
% Heavy Vehicles	0	0	0	0	0	0	0.5	0	0	0.4	0	11.1	0	0	2.0	2.9	2.0	0	0	1.8	1.0

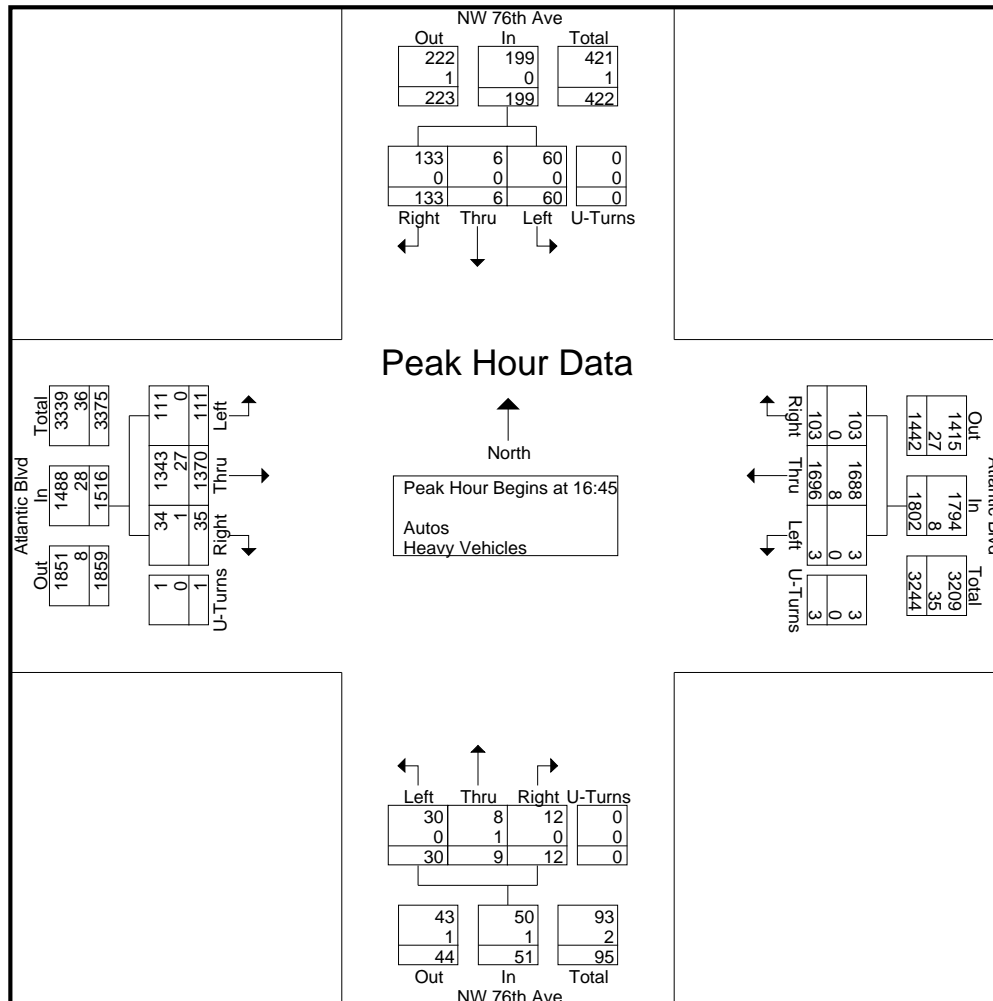

Traf Tech Engineering Inc.

File Name : 7-NW 76th Ave & Atlantic Blvd
 Site Code : 00000000
 Start Date : 5/11/2022
 Page No : 4

Start Time	NW 76th Ave From North					Atlantic Blvd From East					NW 76th Ave From South					Atlantic Blvd From West					Int. Total
	Right	Thru	Left	U-Turns	App. Total	Right	Thru	Left	U-Turns	App. Total	Right	Thru	Left	U-Turns	App. Total	Right	Thru	Left	U-Turns	App. Total	
Peak Hour Analysis From 07:00 to 08:45 - Peak 1 of 1																					
Peak Hour for Entire Intersection Begins at 07:15																					
07:15	29	3	31	0	63	10	200	0	1	211	4	2	8	0	14	11	410	8	0	429	717
07:30	35	6	13	0	54	10	216	0	0	226	5	3	8	0	16	18	423	10	0	451	747
07:45	37	4	15	0	56	14	261	0	0	275	4	5	10	0	19	17	395	16	2	430	780
08:00	40	9	18	0	67	18	220	0	4	242	4	2	5	0	11	4	407	19	0	430	750
Total Volume	141	22	77	0	240	52	897	0	5	954	17	12	31	0	60	50	1635	53	2	1740	2994
% App. Total	58.8	9.2	32.1	0		5.5	94	0	0.5		28.3	20	51.7	0		2.9	94	3	0.1		
PHF	.881	.611	.621	.000	.896	.722	.859	.000	.313	.867	.850	.600	.775	.000	.789	.694	.966	.697	.250	.965	.960
Autos	141	22	77	0	240	49	857	0	4	910	16	12	31	0	59	50	1624				
% Autos	100	100	100	0	100	94.2	95.5	0	80.0	95.4	94.1	100	100	0	98.3	100	99.3	98.1	100	99.3	98.1
Heavy Vehicles																					
% Heavy Vehicles	0	0	0	0	0	5.8	4.5	0	20.0	4.6	5.9	0	0	0	1.7	0	0.7	1.9	0	0.7	1.9

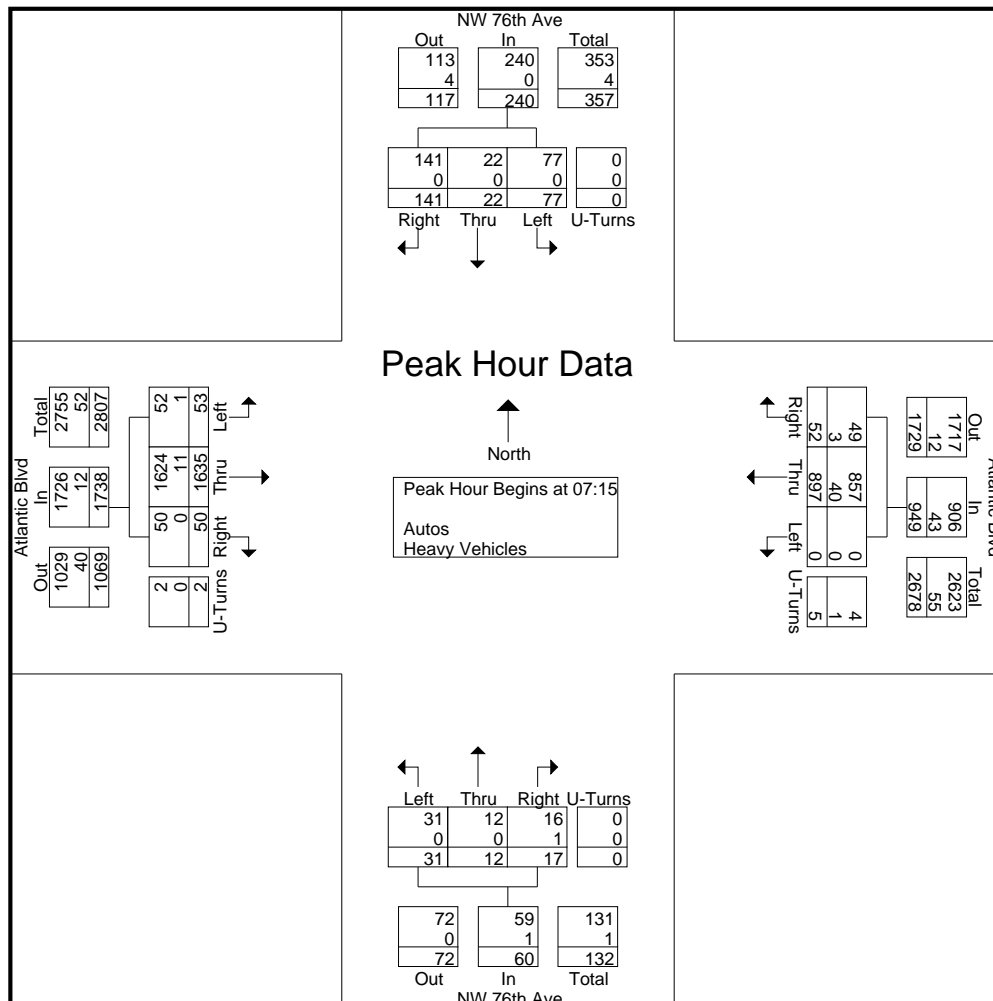

Traf Tech Engineering Inc.

File Name : 7-NW 76th Ave & Atlantic Blvd
 Site Code : 00000000
 Start Date : 5/11/2022
 Page No : 5

Start Time	NW 76th Ave From North					Atlantic Blvd From East					NW 76th Ave From South					Atlantic Blvd From West					Int. Total
	Right	Thru	Left	U-Turns	App. Total	Right	Thru	Left	U-Turns	App. Total	Right	Thru	Left	U-Turns	App. Total	Right	Thru	Left	U-Turns	App. Total	

Peak Hour Analysis From 16:00 to 17:45 - Peak 1 of 1

Peak Hour for Entire Intersection Begins at 16:45

16:45	32	1	15	0	48	30	410	1	0	441	2	0	15	0	17	6	331	25	0	362	868
17:00	17	0	13	0	30	15	404	1	2	422	5	1	2	0	8	7	386	31	0	424	884
17:15	38	2	18	0	58	29	439	0	1	469	4	5	10	0	19	8	320	32	1	361	907
17:30	46	3	14	0	63	29	443	1	0	473	1	3	3	0	7	14	333	23	0	370	913
Total Volume	133	6	60	0	199	103	1696	3	3	1805	12	9	30	0	51	35	1370	111	1	1517	3572
% App. Total	66.8	3	30.2	0		5.7	94	0.2	0.2		23.5	17.6	58.8	0		2.3	90.3	7.3	0.1		
PHF	.723	.500	.833	.000	.790	.858	.957	.750	.375	.954	.600	.450	.500	.000	.671	.625	.887	.867	.250	.894	.978
Autos	133	6	60	0	199	103	1688										1343				
% Autos	100	100	100	0	100	100	99.5	100	100	99.6	100	88.9	100	0	98.0	97.1	98.0	100	100	98.2	99.0
Heavy Vehicles																					
% Heavy Vehicles	0	0	0	0	0	0	0.5	0	0	0.4	0	11.1	0	0	2.0	2.9	2.0	0	0	1.8	1.0

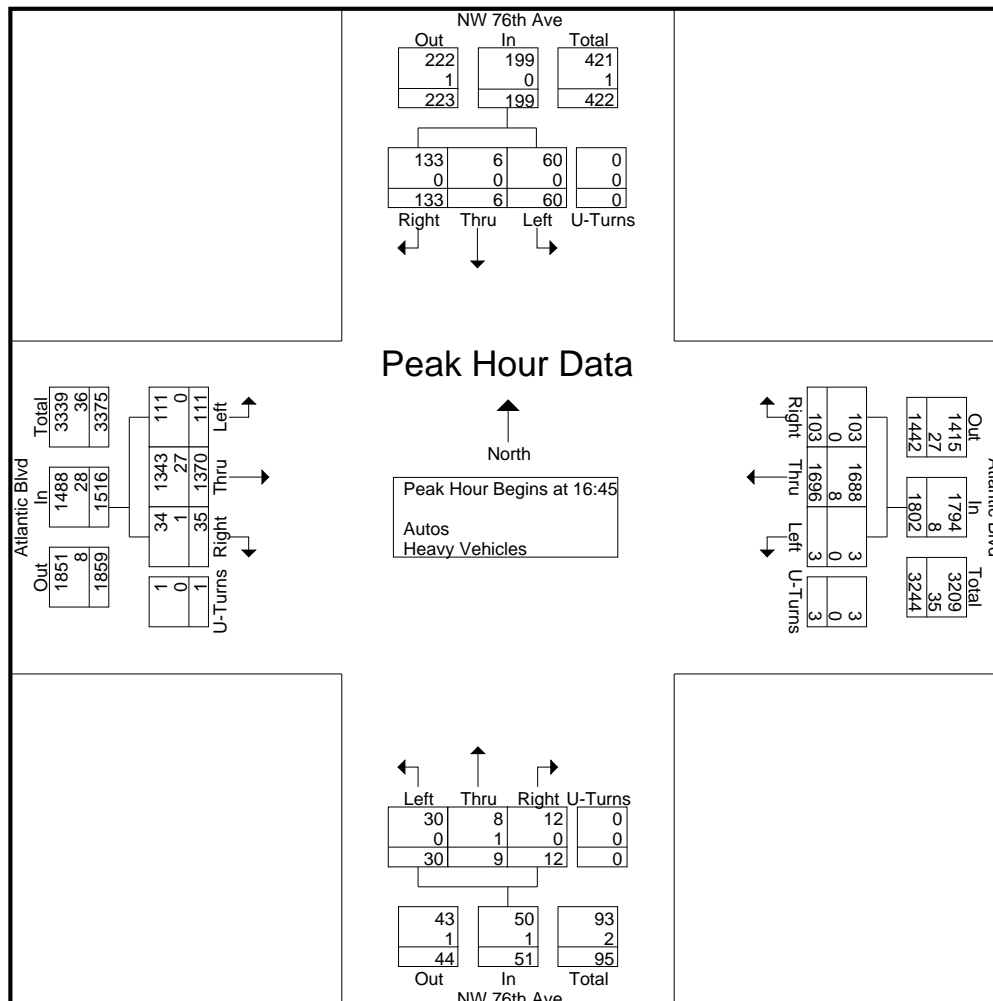

Traf Tech Engineering Inc.

File Name : 8-Rock Island Rd & Atlantic Blvd
 Site Code : 00000000
 Start Date : 5/11/2022
 Page No : 1

Groups Printed- Peds & Bikes

Start Time	Rock Island Rd From North				Atlantic Blvd From East				Rock Island Rd From South				Atlantic Blvd From West				Int. Total	
	Bikes			Peds	Bikes			Peds	Bikes			Peds	Bikes			Peds		
07:00	0	0	0	0	0	0	0	0	0	0	0	0	3	0	0	0	1	4
*** BREAK ***																		
07:30	0	0	0	0	0	0	0	0	0	1	0	0	1	0	0	0	0	2
07:45	0	0	0	1	0	0	0	0	0	0	0	0	0	0	0	0	0	1
Total	0	0	0	1	0	0	0	0	0	1	0	0	4	0	0	0	1	7
08:00	0	0	0	0	0	0	0	0	0	0	0	0	0	1	0	0	1	2
08:15	0	0	0	1	0	0	0	0	0	0	0	0	0	1	0	0	0	2
08:30	0	0	0	0	1	0	0	0	0	0	0	0	0	0	0	0	0	1
*** BREAK ***																		
Total	0	0	0	1	1	0	0	0	0	0	0	0	0	2	0	0	1	5
*** BREAK ***																		
16:00	0	0	0	0	0	0	0	0	0	0	0	0	1	0	0	0	0	1
*** BREAK ***																		
16:30	0	0	0	1	0	0	0	0	0	0	0	0	0	1	0	0	0	2
16:45	0	0	0	0	0	0	0	0	0	0	0	0	0	0	0	0	1	1
Total	0	0	0	1	0	0	0	0	0	0	0	0	1	1	0	0	1	4
17:00	1	0	0	1	0	0	0	0	0	0	0	0	0	0	0	0	0	2
17:15	0	0	0	0	0	0	0	0	0	0	0	0	0	0	0	0	1	1
*** BREAK ***																		
17:45	0	0	0	0	0	0	0	0	0	0	0	0	0	0	0	0	1	1
Total	1	0	0	1	0	0	0	0	0	0	0	0	0	0	0	0	2	4
Grand Total	1	0	0	4	1	0	0	0	1	0	0	5	3	0	0	5		20
Apprch %	20	0	0	80	100	0	0	0	16.7	0	0	83.3	37.5	0	0	62.5		
Total %	5	0	0	20	5	0	0	0	5	0	0	25	15	0	0	25		

Traf Tech Engineering Inc.

File Name : 8-Rock Island Rd & Atlantic Blvd

Site Code : 00000000

Start Date : 5/11/2022

Page No : 1

Groups Printed- Autos - Heavy Vehicles

Start Time	Rock Island Rd From North					Atlantic Blvd From East					Rock Island Rd From South					Atlantic Blvd From West					Int. Total
	Right	Thru	Left	U-Turns	App. Total	Right	Thru	Left	U-Turns	App. Total	Right	Thru	Left	U-Turns	App. Total	Right	Thru	Left	U-Turns	App. Total	
07:00	22	178	35	0	235	17	156	54	0	227	95	169	23	0	287	64	277	22	2	365	1114
07:15	19	208	56	0	283	15	150	60	0	225	98	255	46	0	399	40	250	34	1	325	1232
07:30	19	181	49	0	249	12	158	52	0	222	112	202	59	2	375	57	320	31	0	408	1254
07:45	29	204	41	0	274	21	170	74	2	267	108	210	68	0	386	43	305	35	2	385	1312
Total	89	771	181	0	1041	65	634	240	2	941	413	836	196	2	1447	204	1152	122	5	1483	4912
08:00	29	192	41	0	262	21	158	50	0	229	113	223	60	0	396	66	276	34	1	377	1264
08:15	27	203	35	0	265	24	156	70	1	251	90	196	64	0	350	81	266	27	1	375	1241
08:30	19	157	31	0	207	19	154	81	0	254	71	153	59	2	285	68	208	43	0	319	1065
08:45	29	191	32	0	252	31	154	66	0	251	97	155	77	1	330	74	228	32	0	334	1167
Total	104	743	139	0	986	95	622	267	1	985	371	727	260	3	1361	289	978	136	2	1405	4737
*** BREAK ***																					
16:00	36	187	32	1	256	34	260	103	0	397	69	151	68	1	289	97	188	46	0	331	1273
16:15	20	178	19	0	217	47	338	118	1	504	44	164	75	0	283	68	258	64	1	391	1395
16:30	30	188	26	0	244	39	248	128	1	416	60	170	71	1	302	57	196	49	3	305	1267
16:45	26	179	21	0	226	43	330	86	2	461	60	181	94	2	337	59	247	51	1	358	1382
Total	112	732	98	1	943	163	1176	435	4	1778	233	666	308	4	1211	281	889	210	5	1385	5317
17:00	33	179	37	0	249	34	348	118	3	503	83	165	98	0	346	72	265	67	1	405	1503
17:15	26	197	31	0	254	27	318	113	1	459	64	203	85	1	353	65	216	41	3	325	1391
17:30	26	174	34	0	234	40	369	109	2	520	69	157	91	1	318	77	204	48	1	330	1402
17:45	40	190	32	0	262	30	332	123	3	488	77	181	67	1	326	52	235	43	2	332	1408
Total	125	740	134	0	999	131	1367	463	9	1970	293	706	341	3	1343	266	920	199	7	1392	5704
Grand Total	430	2986	552	1	3969	454	3799	1405	16	5674	1310	2935	1105	12	5362	1040	3939	667	19	5665	20670
Apprch %	10.8	75.2	13.9	0		8	67	24.8	0.3		24.4	54.7	20.6	0.2		18.4	69.5	11.8	0.3		
Total %	2.1	14.4	2.7	0	19.2	2.2	18.4	6.8	0.1	27.5	6.3	14.2	5.3	0.1	25.9	5	19.1	3.2	0.1	27.4	
Autos	419	2954					3719	1378			1282	2888	1092			1029	3877				20331
% Autos	97.4	98.9	98.2	100	98.7	98.9	97.9	98.1	100	98	97.9	98.4	98.8	100	98.4	98.9	98.4	98.1	100	98.5	98.4
Heavy Vehicles																					
% Heavy Vehicles	2.6	1.1	1.8	0	1.3	1.1	2.1	1.9	0	2	2.1	1.6	1.2	0	1.6	1.1	1.6	1.9	0	1.5	1.6

Traf Tech Engineering Inc.

File Name : 8-Rock Island Rd & Atlantic Blvd
 Site Code : 00000000
 Start Date : 5/11/2022
 Page No : 2

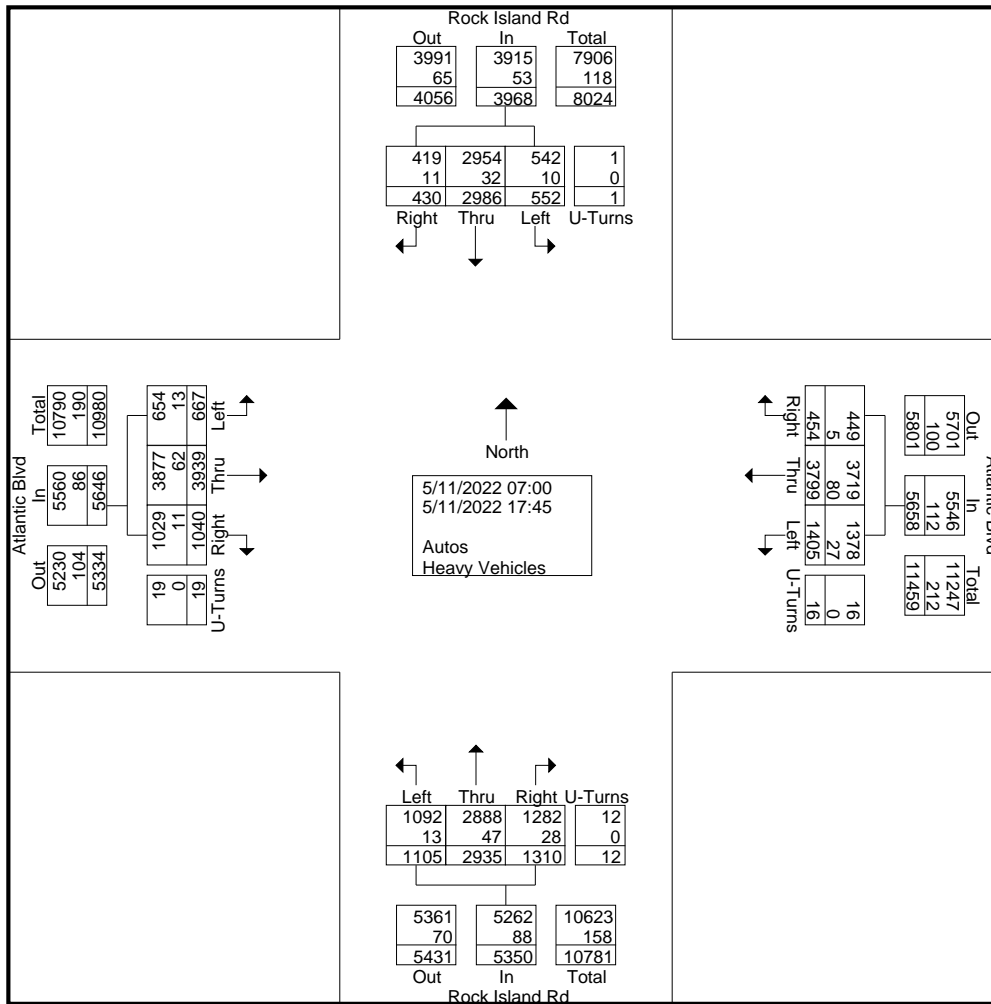

Traf Tech Engineering Inc.

File Name : 8-Rock Island Rd & Atlantic Blvd
 Site Code : 00000000
 Start Date : 5/11/2022
 Page No : 3

Start Time	Rock Island Rd From North					Atlantic Blvd From East					Rock Island Rd From South					Atlantic Blvd From West					Int. Total
	Right	Thru	Left	U-Turns	App. Total	Right	Thru	Left	U-Turns	App. Total	Right	Thru	Left	U-Turns	App. Total	Right	Thru	Left	U-Turns	App. Total	
Peak Hour Analysis From 07:00 to 17:45 - Peak 1 of 1																					
Peak Hour for Entire Intersection Begins at 17:00																					
17:00	33	179	37	0	249	34	348	118	3	503	83	165	98	0	346	72	265	67	1	405	1503
17:15	26	197	31	0	254	27	318	113	1	459	64	203	85	1	353	65	216	41	3	325	1391
17:30	26	174	34	0	234	40	369	109	2	520	69	157	91	1	318	77	204	48	1	330	1402
17:45	40	190	32	0	262	30	332	123	3	488	77	181	67	1	326	52	235	43	2	332	1408
Total Volume	125	740	134	0	999	131	1367	463	9	1970	293	706	341	3	1343	266	920	199	7	1392	5704
% App. Total	12.5	74.1	13.4	0		6.6	69.4	23.5	0.5		21.8	52.6	25.4	0.2		19.1	66.1	14.3	0.5		
PHF	.781	.939	.905	.000	.953	.819	.926	.941	.750	.947	.883	.869	.870	.750	.951	.864	.868	.743	.583	.859	.949
Autos	124	731	133	0	988	130	1359				97.6	98.7	99.7	100	98.7	99.2	98.2	98.5	100	98.4	98.9
% Autos	99.2	98.8	99.3	0	98.9	99.2	99.4	99.1	100	99.3	97.6	98.7	99.7	100	98.7	99.2	98.2	98.5	100	98.4	98.9
Heavy Vehicles																					
% Heavy Vehicles	0.8	1.2	0.7	0	1.1	0.8	0.6	0.9	0	0.7	2.4	1.3	0.3	0	1.3	0.8	1.8	1.5	0	1.6	1.1

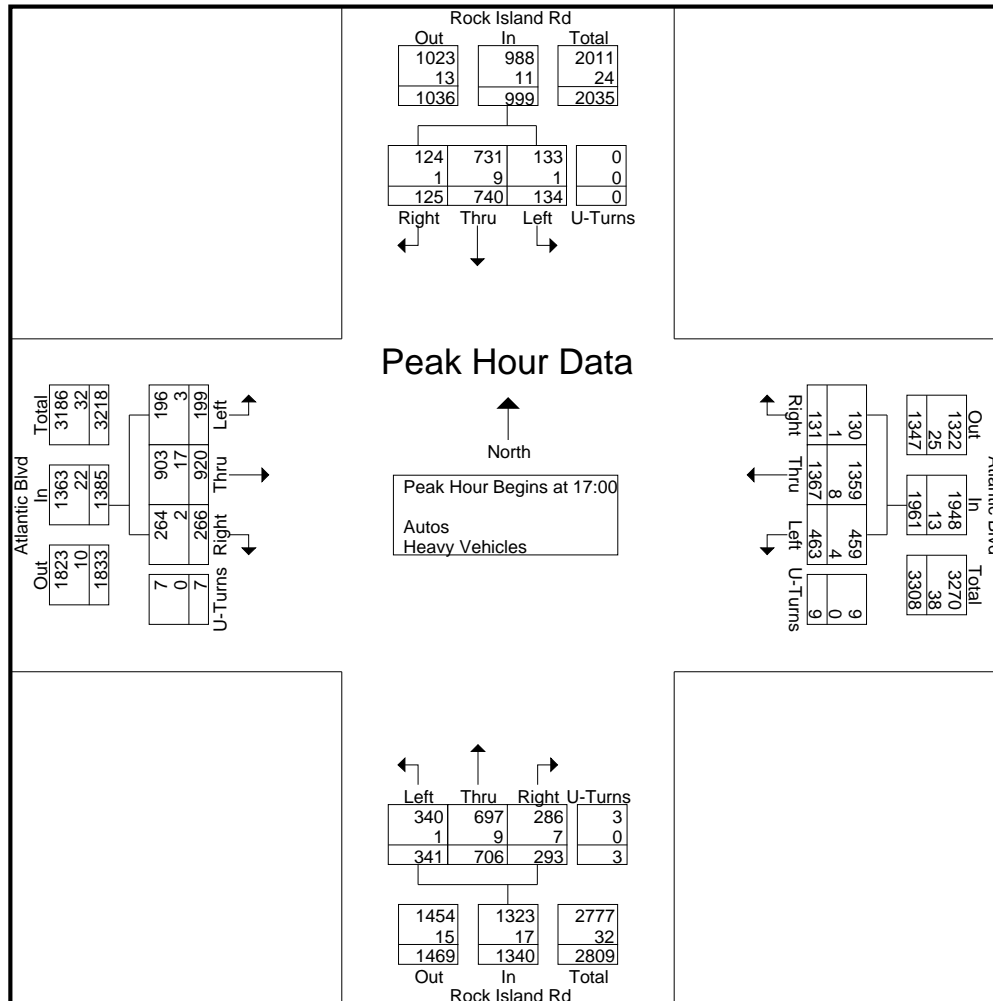

Traf Tech Engineering Inc.

File Name : 8-Rock Island Rd & Atlantic Blvd
 Site Code : 00000000
 Start Date : 5/11/2022
 Page No : 4

Start Time	Rock Island Rd From North					Atlantic Blvd From East					Rock Island Rd From South					Atlantic Blvd From West					Int. Total
	Right	Thru	Left	U-Turns	App. Total	Right	Thru	Left	U-Turns	App. Total	Right	Thru	Left	U-Turns	App. Total	Right	Thru	Left	U-Turns	App. Total	
Peak Hour Analysis From 07:00 to 08:45 - Peak 1 of 1																					
Peak Hour for Entire Intersection Begins at 07:30																					
07:30	19	181	49	0	249	12	158	52	0	222	112	202	59	2	375	57	320	31	0	408	1254
07:45	29	204	41	0	274	21	170	74	2	267	108	210	68	0	386	43	305	35	2	385	1312
08:00	29	192	41	0	262	21	158	50	0	229	113	223	60	0	396	66	276	34	1	377	1264
08:15	27	203	35	0	265	24	156	70	1	251	90	196	64	0	350	81	266	27	1	375	1241
Total Volume	104	780	166	0	1050	78	642	246	3	969	423	831	251	2	1507	247	1167	127	4	1545	5071
% App. Total	9.9	74.3	15.8	0		8	66.3	25.4	0.3		28.1	55.1	16.7	0.1		16	75.5	8.2	0.3		
PHF	.897	.956	.847	.000	.958	.813	.944	.831	.375	.907	.936	.932	.923	.250	.951	.762	.912	.907	.500	.947	.966
Autos	102	771	164	0	1037	75	606	236	3	920	417	815	244	2	1478	244	1155				
% Autos	98.1	98.8	98.8	0	98.8	96.2	94.4	95.9	100	94.9	98.6	98.1	97.2	100	98.1	98.8	99.0	96.1	100	98.7	97.8
Heavy Vehicles																					
% Heavy Vehicles	1.9	1.2	1.2	0	1.2	3.8	5.6	4.1	0	5.1	1.4	1.9	2.8	0	1.9	1.2	1.0	3.9	0	1.3	2.2

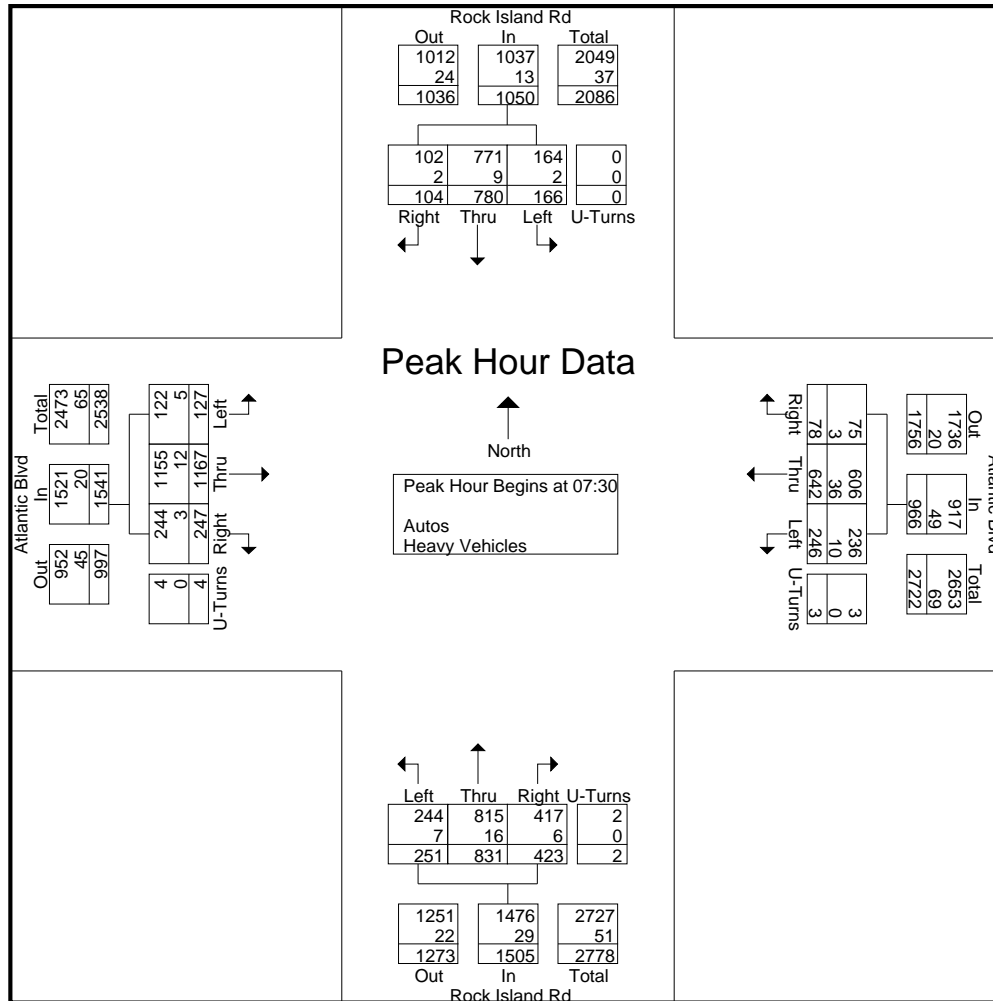

Traf Tech Engineering Inc.

File Name : 8-Rock Island Rd & Atlantic Blvd
 Site Code : 00000000
 Start Date : 5/11/2022
 Page No : 5

Start Time	Rock Island Rd From North					Atlantic Blvd From East					Rock Island Rd From South					Atlantic Blvd From West					Int. Total
	Right	Thru	Left	U-Turns	App. Total	Right	Thru	Left	U-Turns	App. Total	Right	Thru	Left	U-Turns	App. Total	Right	Thru	Left	U-Turns	App. Total	
Peak Hour Analysis From 16:00 to 17:45 - Peak 1 of 1																					
Peak Hour for Entire Intersection Begins at 17:00																					
17:00	33	179	37	0	249	34	348	118	3	503	83	165	98	0	346	72	265	67	1	405	1503
17:15	26	197	31	0	254	27	318	113	1	459	64	203	85	1	353	65	216	41	3	325	1391
17:30	26	174	34	0	234	40	369	109	2	520	69	157	91	1	318	77	204	48	1	330	1402
17:45	40	190	32	0	262	30	332	123	3	488	77	181	67	1	326	52	235	43	2	332	1408
Total Volume	125	740	134	0	999	131	1367	463	9	1970	293	706	341	3	1343	266	920	199	7	1392	5704
% App. Total	12.5	74.1	13.4	0		6.6	69.4	23.5	0.5		21.8	52.6	25.4	0.2		19.1	66.1	14.3	0.5		
PHF	.781	.939	.905	.000	.953	.819	.926	.941	.750	.947	.883	.869	.870	.750	.951	.864	.868	.743	.583	.859	.949
Autos	124	731	133	0	988	130	1359				97.6	98.7	99.7	100	98.7	99.2	98.2	98.5	100	98.4	98.9
% Autos	99.2	98.8	99.3	0	98.9	99.2	99.4	99.1	100	99.3											
Heavy Vehicles																					
% Heavy Vehicles	0.8	1.2	0.7	0	1.1	0.8	0.6	0.9	0	0.7	2.4	1.3	0.3	0	1.3	0.8	1.8	1.5	0	1.6	1.1

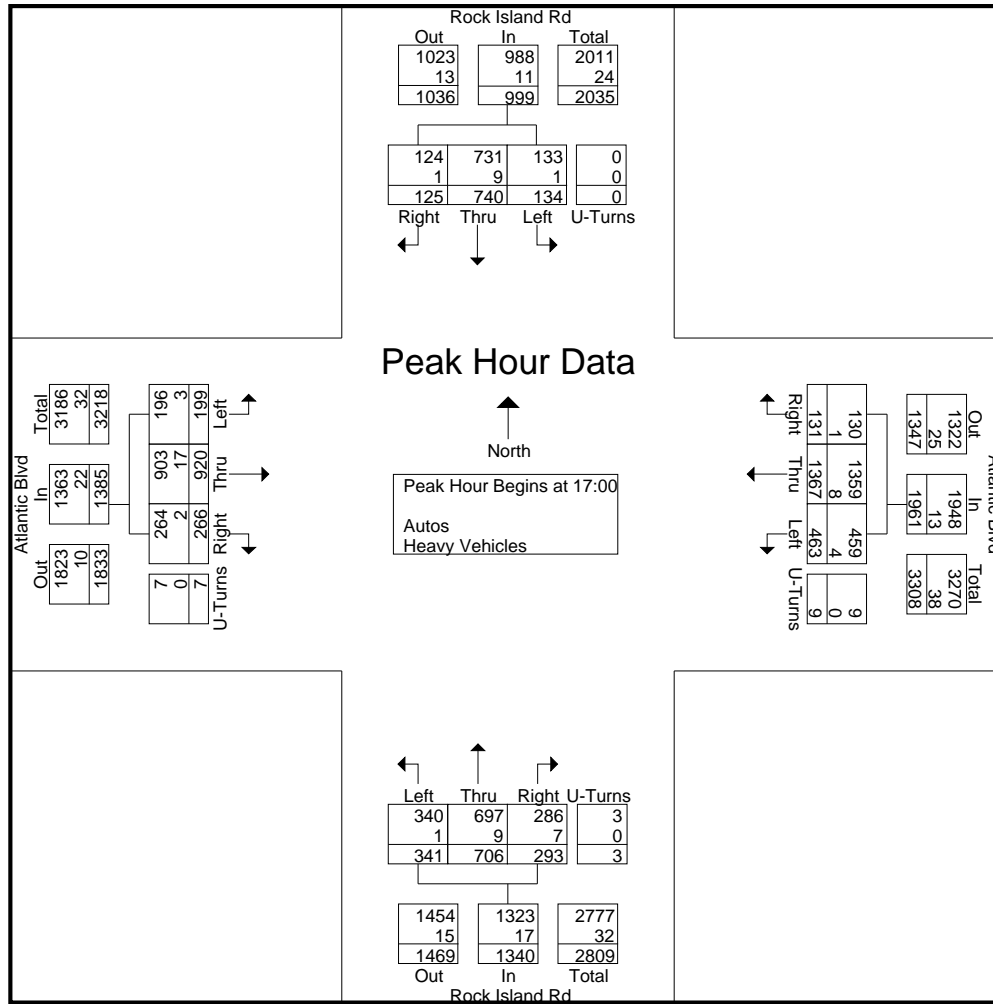

Traf Tech Engineering Inc.

File Name : 9-SR-7 & Atlantic Blvd
 Site Code : 00000000
 Start Date : 5/11/2022
 Page No : 1

Groups Printed- Peds & Bikes

Start Time	SR-7 From North				Atlantic Blvd From East				SR-7 From South				Atlantic Blvd From West				Int. Total	
	Bikes			Peds	Bikes			Peds	Bikes			Peds	Bikes			Peds		
07:00	0	0	0	0	0	0	0	0	0	0	0	0	1	1	0	0	1	3
07:15	0	0	0	1	0	0	0	0	0	0	0	0	0	1	0	0	2	4
07:30	0	0	0	0	0	0	0	0	0	0	0	0	1	0	0	0	1	1
07:45	0	0	0	0	0	0	0	1	0	0	0	0	1	0	0	0	1	3
Total	0	0	0	1	0	0	0	1	0	0	0	1	4	0	0	0	4	11
08:00	0	0	0	0	0	0	0	0	0	0	0	1	0	0	0	0	1	2
08:15	0	0	0	3	0	0	0	1	0	0	0	0	0	0	0	0	5	9
08:30	0	0	0	8	0	0	0	1	0	0	0	3	0	0	0	0	6	18
08:45	0	0	0	5	0	0	0	3	0	0	0	7	0	0	0	0	6	21
Total	0	0	0	16	0	0	0	5	0	0	0	11	0	0	0	0	18	50
*** BREAK ***																		
16:00	1	0	0	8	0	0	0	4	0	0	0	13	0	0	0	0	40	66
16:15	0	0	0	0	0	0	0	0	0	0	0	1	0	0	0	0	0	1
16:30	0	0	0	0	0	0	0	4	0	0	0	0	1	0	0	0	0	5
16:45	0	0	0	3	0	0	0	0	0	0	0	0	0	0	0	0	0	3
Total	1	0	0	11	0	0	0	8	0	0	0	14	1	0	0	0	40	75
17:00	0	0	0	2	0	0	0	1	0	0	0	1	0	0	0	0	0	4
17:15	0	0	0	3	0	0	0	1	0	0	0	0	0	0	0	0	1	5
17:30	0	0	0	0	0	0	0	4	0	0	0	0	0	0	0	0	0	4
17:45	0	0	0	1	0	0	0	0	0	0	0	0	0	0	0	0	0	1
Total	0	0	0	6	0	0	0	6	0	0	0	1	0	0	0	0	1	14
Grand Total	1	0	0	34	0	0	0	20	0	0	0	27	5	0	0	0	63	150
Apprch %	2.9	0	0	97.1	0	0	0	100	0	0	0	100	7.4	0	0	0	92.6	
Total %	0.7	0	0	22.7	0	0	0	13.3	0	0	0	18	3.3	0	0	0	42	

Traf Tech Engineering Inc.

File Name : 9-SR-7 & Atlantic Blvd
 Site Code : 00000000
 Start Date : 5/11/2022
 Page No : 1

Groups Printed- Autos - Heavy Vehicles

Start Time	SR-7 From North					Atlantic Blvd From East					SR-7 From South					Atlantic Blvd From West					Int. Total
	Right	Thru	Left	U-Turns	App. Total	Right	Thru	Left	U-Turns	App. Total	Right	Thru	Left	U-Turns	App. Total	Right	Thru	Left	U-Turns	App. Total	
07:00	24	255	62	0	341	40	171	61	1	273	156	357	25	1	539	24	289	93	1	407	1560
07:15	26	225	60	0	311	52	149	74	0	275	117	341	22	0	480	38	371	85	1	495	1561
07:30	33	287	63	0	383	32	152	65	2	251	134	403	21	0	558	39	321	108	2	470	1662
07:45	31	264	64	2	361	43	193	55	0	291	126	340	22	0	488	53	376	119	0	548	1688
Total	114	1031	249	2	1396	167	665	255	3	1090	533	1441	90	1	2065	154	1357	405	4	1920	6471
08:00	37	277	52	0	366	47	196	75	1	319	117	360	26	0	503	31	305	115	3	454	1642
08:15	41	331	64	0	436	34	165	66	2	267	111	363	36	2	512	46	251	78	2	377	1592
08:30	41	280	67	1	389	38	208	82	3	331	92	277	33	0	402	60	261	99	2	422	1544
08:45	52	246	42	4	344	26	148	76	5	255	90	310	34	1	435	51	213	100	1	365	1399
Total	171	1134	225	5	1535	145	717	299	11	1172	410	1310	129	3	1852	188	1030	392	8	1618	6177
*** BREAK ***																					
16:00	26	288	26	4	344	44	274	152	2	472	99	305	41	2	447	76	226	80	3	385	1648
16:15	38	333	40	0	411	42	306	136	1	485	127	288	44	8	467	65	198	67	4	334	1697
16:30	36	270	31	1	338	46	320	141	2	509	107	248	54	7	416	60	249	87	2	398	1661
16:45	46	321	19	0	386	34	306	141	1	482	103	306	47	4	460	57	180	84	3	324	1652
Total	146	1212	116	5	1479	166	1206	570	6	1948	436	1147	186	21	1790	258	853	318	12	1441	6658
17:00	42	297	29	1	369	34	369	148	2	553	99	286	51	3	439	58	265	64	1	388	1749
17:15	46	313	34	3	396	29	387	161	1	578	110	271	44	2	427	70	246	87	6	409	1810
17:30	50	326	26	0	402	23	336	152	3	514	113	355	46	6	520	54	179	79	6	318	1754
17:45	53	300	25	2	380	31	364	134	3	532	111	274	37	13	435	62	229	73	2	366	1713
Total	191	1236	114	6	1547	117	1456	595	9	2177	433	1186	178	24	1821	244	919	303	15	1481	7026
Grand Total	622	4613	704	18	5957	595	4044	1719	29	6387	1812	5084	583	49	7528	844	4159	1418	39	6460	26332
Apprch %	10.4	77.4	11.8	0.3		9.3	63.3	26.9	0.5		24.1	67.5	7.7	0.7		13.1	64.4	22	0.6		
Total %	2.4	17.5	2.7	0.1	22.6	2.3	15.4	6.5	0.1	24.3	6.9	19.3	2.2	0.2	28.6	3.2	15.8	5.4	0.1	24.5	
Autos	611	4509				3955	1671				1771	4984				4077	1396				25780
% Autos	98.2	97.7	98.4	94.4	97.9	96.5	97.8	97.2	100	97.5	97.7	98	97.8	100	98	98.9	98	98.4	100	98.3	97.9
Heavy Vehicles																					
% Heavy Vehicles	1.8	2.3	1.6	5.6	2.1	3.5	2.2	2.8	0	2.5	2.3	2	2.2	0	2	1.1	2	1.6	0	1.7	2.1

Traf Tech Engineering Inc.

File Name : 9-SR-7 & Atlantic Blvd
 Site Code : 00000000
 Start Date : 5/11/2022
 Page No : 2

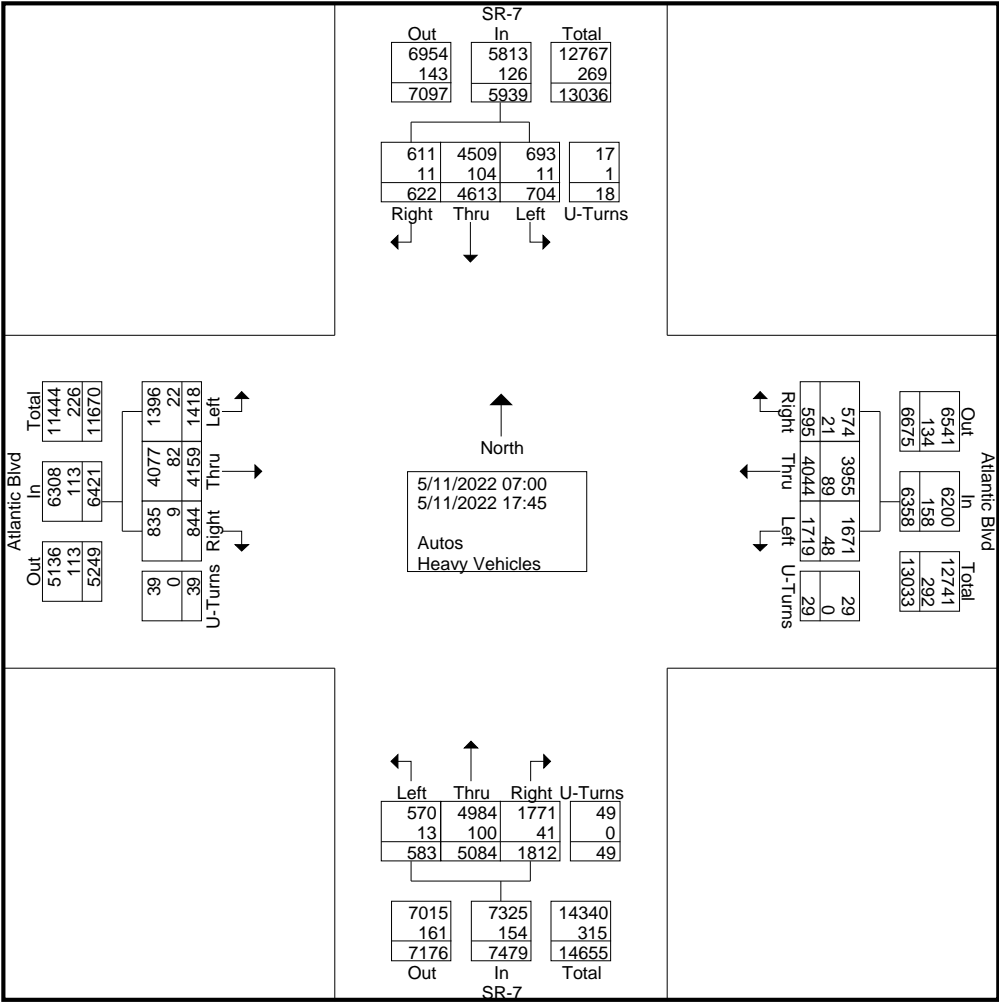

Traf Tech Engineering Inc.

File Name : 9-SR-7 & Atlantic Blvd
 Site Code : 00000000
 Start Date : 5/11/2022
 Page No : 3

Start Time	SR-7 From North					Atlantic Blvd From East					SR-7 From South					Atlantic Blvd From West					Int. Total		
	Right	Thru	Left	U-Turns	App. Total	Right	Thru	Left	U-Turns	App. Total	Right	Thru	Left	U-Turns	App. Total	Right	Thru	Left	U-Turns	App. Total			
Peak Hour Analysis From 07:00 to 17:45 - Peak 1 of 1																							
Peak Hour for Entire Intersection Begins at 17:00																							
17:00	42	297	29	1	369	34	369	148	2	553	99	286	51	3	439	58	265	64	1	388	1749		
17:15	46	313	34	3	396	29	387	161	1	578	110	271	44	2	427	70	246	87	6	409	1810		
17:30	50	326	26	0	402	23	336	152	3	514	113	355	46	6	520	54	179	79	6	318	1754		
17:45	53	300	25	2	380	31	364	134	3	532	111	274	37	13	435	62	229	73	2	366	1713		
Total Volume	191	1236	114	6	1547	117	1456	595	9	2177	433	1186	178	24	1821	244	919	303	15	1481	7026		
% App. Total	12.3	79.9	7.4	0.4		5.4	66.9	27.3	0.4		23.8	65.1	9.8	1.3		16.5	62.1	20.5	1				
PHF	.901	.948	.838	.500	.962	.860	.941	.924	.750	.942	.958	.835	.873	.462	.875	.871	.867	.871	.625	.905	.970		
Autos	190	1223				1448					1164												
% Autos	99.5	98.9	96.5	100	98.8	98.3	99.5	99.5	100	99.4	97.2	98.1	98.9	100	98.0	99.2	97.4	99.0	100	98.0	98.6		
Heavy Vehicles																							
% Heavy Vehicles	0.5	1.1	3.5	0	1.2	1.7	0.5	0.5	0	0.6	2.8	1.9	1.1	0	2.0	0.8	2.6	1.0	0	2.0	1.4		

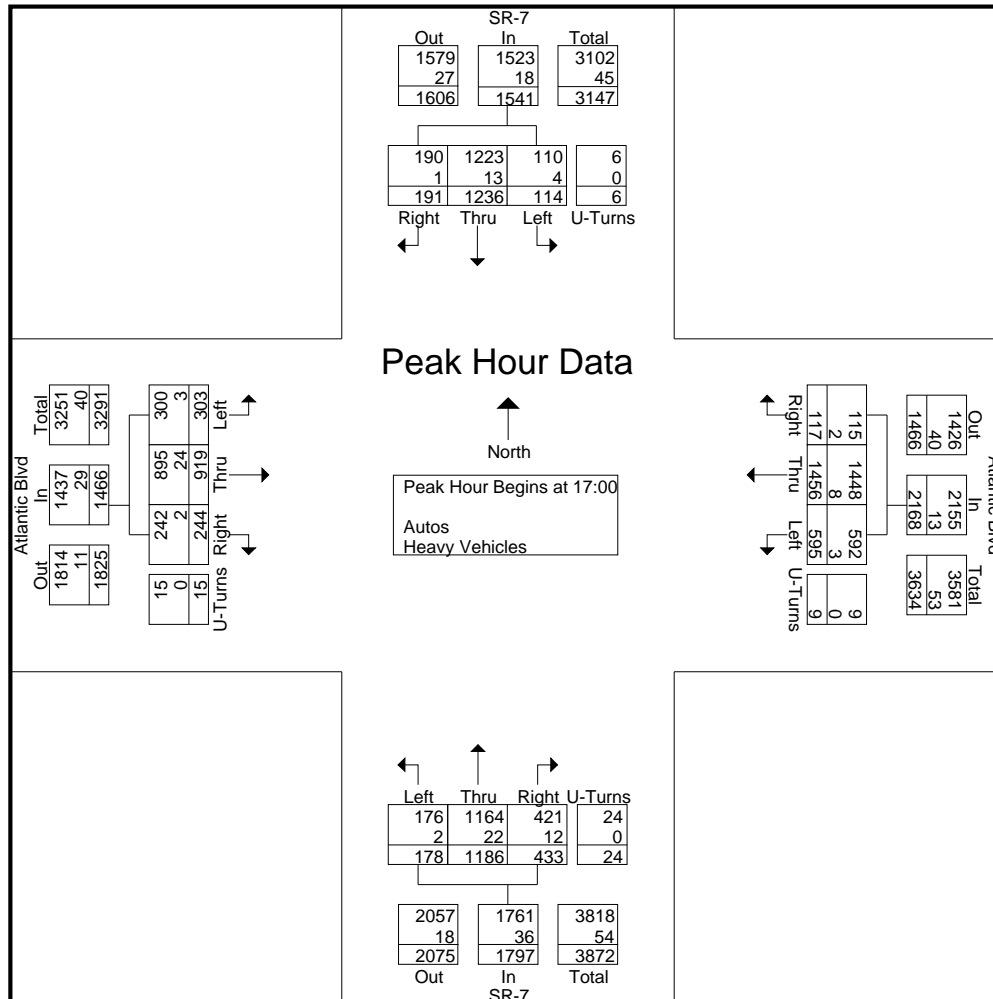

Traf Tech Engineering Inc.

File Name : 9-SR-7 & Atlantic Blvd
 Site Code : 00000000
 Start Date : 5/11/2022
 Page No : 4

Start Time	SR-7 From North					Atlantic Blvd From East					SR-7 From South					Atlantic Blvd From West					Int. Total
	Right	Thru	Left	U-Turns	App. Total	Right	Thru	Left	U-Turns	App. Total	Right	Thru	Left	U-Turns	App. Total	Right	Thru	Left	U-Turns	App. Total	
Peak Hour Analysis From 07:00 to 08:45 - Peak 1 of 1																					
Peak Hour for Entire Intersection Begins at 07:30																					
07:30	33	287	63	0	383	32	152	65	2	251	134	403	21	0	558	39	321	108	2	470	1662
07:45	31	264	64	2	361	43	193	55	0	291	126	340	22	0	488	53	376	119	0	548	1688
08:00	37	277	52	0	366	47	196	75	1	319	117	360	26	0	503	31	305	115	3	454	1642
08:15	41	331	64	0	436	34	165	66	2	267	111	363	36	2	512	46	251	78	2	377	1592
Total Volume	142	1159	243	2	1546	156	706	261	5	1128	488	1466	105	2	2061	169	1253	420	7	1849	6584
% App. Total	9.2	75	15.7	0.1		13.8	62.6	23.1	0.4		23.7	71.1	5.1	0.1		9.1	67.8	22.7	0.4		
PHF	.866	.875	.949	.250	.886	.830	.901	.870	.625	.884	.910	.909	.729	.250	.923	.797	.833	.882	.583	.844	.975
Autos	137	1120									1439				1237						
% Autos	96.5	96.6	98.8	50.0	96.9	92.9	95.2	94.3	100	94.7	98.0	98.2	99.0	100	98.2	100	98.7	98.8	100	98.9	97.5
Heavy Vehicles																					
% Heavy Vehicles	3.5	3.4	1.2	50.0	3.1	7.1	4.8	5.7	0	5.3	2.0	1.8	1.0	0	1.8	0	1.3	1.2	0	1.1	2.5

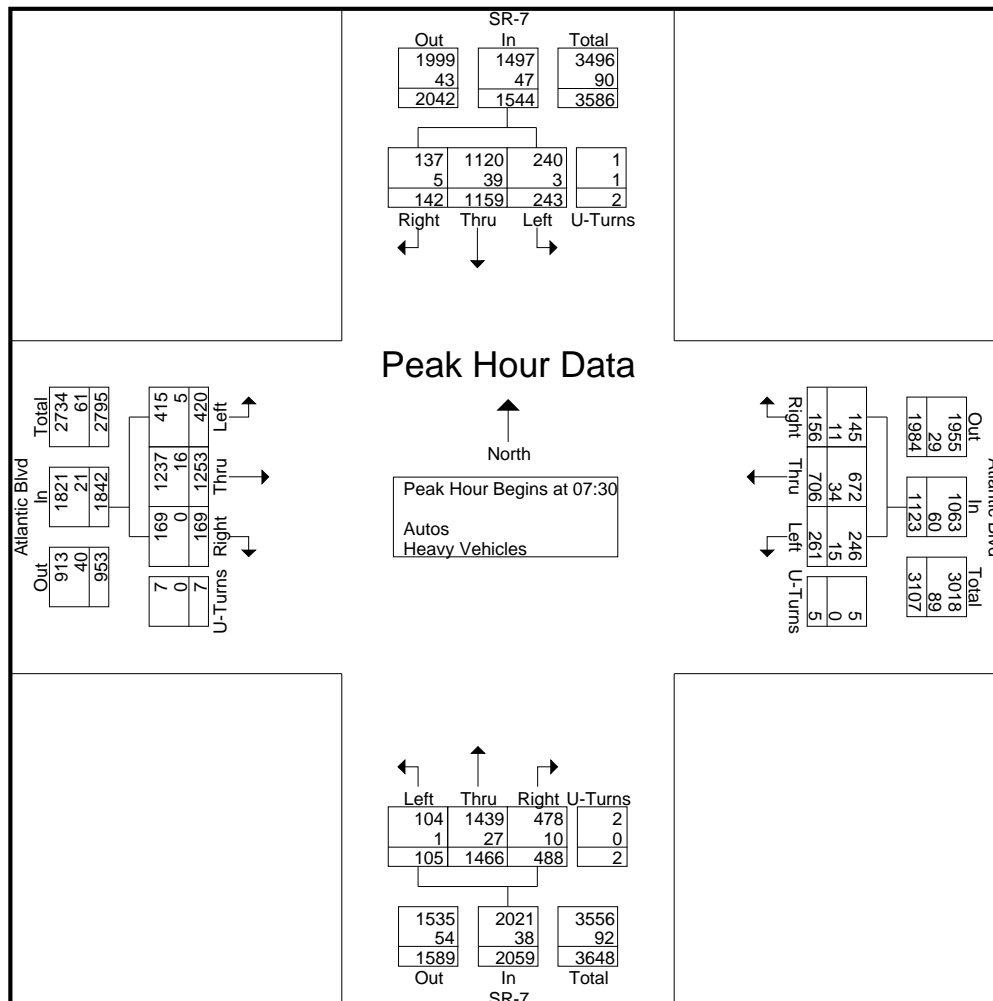

Traf Tech Engineering Inc.

File Name : 9-SR-7 & Atlantic Blvd
 Site Code : 00000000
 Start Date : 5/11/2022
 Page No : 5

Start Time	SR-7 From North					Atlantic Blvd From East					SR-7 From South					Atlantic Blvd From West					Int. Total
	Right	Thru	Left	U-Turns	App. Total	Right	Thru	Left	U-Turns	App. Total	Right	Thru	Left	U-Turns	App. Total	Right	Thru	Left	U-Turns	App. Total	
Peak Hour Analysis From 16:00 to 17:45 - Peak 1 of 1																					
Peak Hour for Entire Intersection Begins at 17:00																					
17:00	42	297	29	1	369	34	369	148	2	553	99	286	51	3	439	58	265	64	1	388	1749
17:15	46	313	34	3	396	29	387	161	1	578	110	271	44	2	427	70	246	87	6	409	1810
17:30	50	326	26	0	402	23	336	152	3	514	113	355	46	6	520	54	179	79	6	318	1754
17:45	53	300	25	2	380	31	364	134	3	532	111	274	37	13	435	62	229	73	2	366	1713
Total Volume	191	1236	114	6	1547	117	1456	595	9	2177	433	1186	178	24	1821	244	919	303	15	1481	7026
% App. Total	12.3	79.9	7.4	0.4		5.4	66.9	27.3	0.4		23.8	65.1	9.8	1.3		16.5	62.1	20.5	1		
PHF	.901	.948	.838	.500	.962	.860	.941	.924	.750	.942	.958	.835	.873	.462	.875	.871	.867	.871	.625	.905	.970
Autos	190	1223					1448					1164									
% Autos	99.5	98.9	96.5	100	98.8	98.3	99.5	99.5	100	99.4	97.2	98.1	98.9	100	98.0	99.2	97.4	99.0	100	98.0	98.6
Heavy Vehicles																					
% Heavy Vehicles	0.5	1.1	3.5	0	1.2	1.7	0.5	0.5	0	0.6	2.8	1.9	1.1	0	2.0	0.8	2.6	1.0	0	2.0	1.4

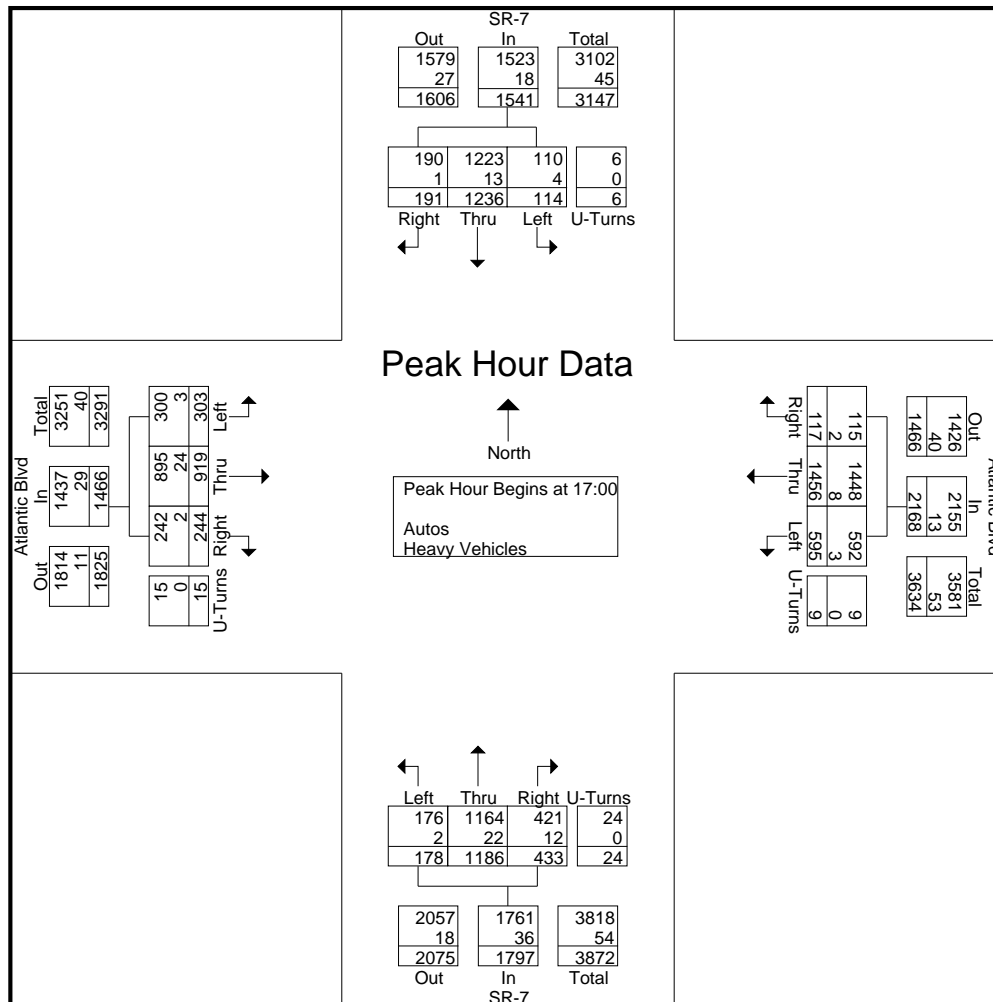

Traf Tech Engineering Inc.

File Name : 1- Rock Island Rd & Royal Palm Blvd
 Site Code : 00000000
 Start Date : 4/26/2023
 Page No : 1

Groups Printed- Peds & Bikes

Start Time	Rock Island Road Southbound				Royal Palm Blvd Westbound				Rock Island Road Northbound				Royal Palm Blvd Eastbound				Int. Total
	Bikes			Peds	Bikes			Peds	Bikes			Peds	Bikes			Peds	
07:00	0	0	0	1	1	0	0	0	0	0	0	0	1	0	0	0	3
*** BREAK ***																	
07:30	1	0	0	0	0	0	0	0	0	0	0	0	3	0	0	0	4
*** BREAK ***																	
Total	1	0	0	1	1	0	0	0	0	0	0	0	4	0	0	0	7
08:00	0	0	0	0	1	0	0	0	0	0	0	0	0	0	0	0	1
08:15	0	0	0	0	1	0	0	0	0	0	0	0	0	0	0	1	2
*** BREAK ***																	
Total	0	0	0	0	2	0	0	0	0	0	0	0	0	0	0	1	3
*** BREAK ***																	
16:00	0	0	0	0	0	0	0	0	0	0	0	1	1	0	0	0	2
16:15	0	0	0	0	0	0	0	0	0	0	0	1	0	0	0	0	1
16:30	0	0	0	0	0	0	0	0	0	0	0	0	1	0	0	1	2
*** BREAK ***																	
Total	0	0	0	0	0	0	0	0	0	0	0	2	2	0	0	1	5
*** BREAK ***																	
Grand Total	1	0	0	1	3	0	0	0	0	0	0	2	6	0	0	2	15
Apprch %	50	0	0	50	100	0	0	0	0	0	0	100	75	0	0	25	
Total %	6.7	0	0	6.7	20	0	0	0	0	0	0	13.3	40	0	0	13.3	

Traf Tech Engineering Inc.

File Name : 1- Rock Island Rd & Royal Palm Blvd

Site Code : 00000000

Start Date : 4/26/2023

Page No : 1

Groups Printed- Autos - Heavy Vehicles

Start Time	Rock Island Road Southbound					Royal Palm Blvd Westbound					Rock Island Road Northbound					Royal Palm Blvd Eastbound					Int. Total
	Right	Thru	Left	U-Turns	App. Total	Right	Thru	Left	U-Turns	App. Total	Right	Thru	Left	U-Turns	App. Total	Right	Thru	Left	U-Turns	App. Total	
07:00	32	119	51	1	203	44	153	29	0	226	57	118	67	0	242	78	207	28	1	314	985
07:15	41	177	63	0	281	45	152	36	0	233	44	183	65	0	292	65	188	42	0	295	1101
07:30	45	181	75	0	301	57	192	32	0	281	55	153	78	2	288	109	265	44	0	418	1288
07:45	41	153	58	1	253	56	198	39	0	293	58	139	111	0	308	88	227	41	1	357	1211
Total	159	630	247	2	1038	202	695	136	0	1033	214	593	321	2	1130	340	887	155	2	1384	4585
08:00	36	170	42	0	248	39	168	51	0	258	53	153	94	0	300	83	192	23	0	298	1104
08:15	44	158	46	0	248	33	198	35	0	266	61	140	80	0	281	85	224	40	0	349	1144
08:30	50	136	40	0	226	30	215	44	1	290	61	114	93	0	268	62	183	25	1	271	1055
08:45	58	156	53	1	268	28	204	52	0	284	68	125	104	2	299	75	188	26	0	289	1140
Total	188	620	181	1	990	130	785	182	1	1098	243	532	371	2	1148	305	787	114	1	1207	4443
*** BREAK ***																					
16:00	31	136	38	0	205	52	224	68	0	344	55	112	76	1	244	54	151	32	0	237	1030
16:15	38	151	42	0	231	34	237	73	0	344	44	119	75	1	239	54	142	34	0	230	1044
16:30	32	174	37	0	243	41	259	62	1	363	45	134	64	2	245	51	129	34	0	214	1065
16:45	44	162	31	0	237	52	238	57	1	348	52	115	99	2	268	44	91	33	1	169	1022
Total	145	623	148	0	916	179	958	260	2	1399	196	480	314	6	996	203	513	133	1	850	4161
17:00	43	172	50	3	268	51	224	63	1	339	57	145	69	4	275	42	137	30	0	209	1091
17:15	36	171	34	0	241	64	226	82	0	372	61	151	91	0	303	60	155	37	0	252	1168
17:30	49	198	47	0	294	47	235	56	0	338	49	151	93	4	297	56	111	32	1	200	1129
17:45	40	163	53	0	256	54	222	64	0	340	73	152	72	5	302	50	123	28	0	201	1099
Total	168	704	184	3	1059	216	907	265	1	1389	240	599	325	13	1177	208	526	127	1	862	4487
Grand Total	660	2577	760	6	4003	727	3345	843	4	4919	893	2204	1331	23	4451	1056	2713	529	5	4303	17676
Apprch %	16.5	64.4	19	0.1		14.8	68	17.1	0.1		20.1	49.5	29.9	0.5		24.5	63	12.3	0.1		
Total %	3.7	14.6	4.3	0	22.6	4.1	18.9	4.8	0	27.8	5.1	12.5	7.5	0.1	25.2	6	15.3	3	0	24.3	
Autos	650	2552	744	6	3952	721	3319	841	4	4885	880	2193	1321	23	4417	1037	2658	515	5	4215	17469
% Autos	98.5	99	97.9	100	98.7	99.2	99.2	99.8	100	99.3	98.5	99.5	99.2	100	99.2	98.2	98	97.4	100	98	98.8
Heavy Vehicles																					
% Heavy Vehicles	1.5	1	2.1	0	1.3	0.8	0.8	0.2	0	0.7	1.5	0.5	0.8	0	0.8	1.8	2	2.6	0	2	1.2

Traf Tech Engineering Inc.

File Name : 1- Rock Island Rd & Royal Palm Blvd

Site Code : 00000000

Start Date : 4/26/2023

Page No : 2

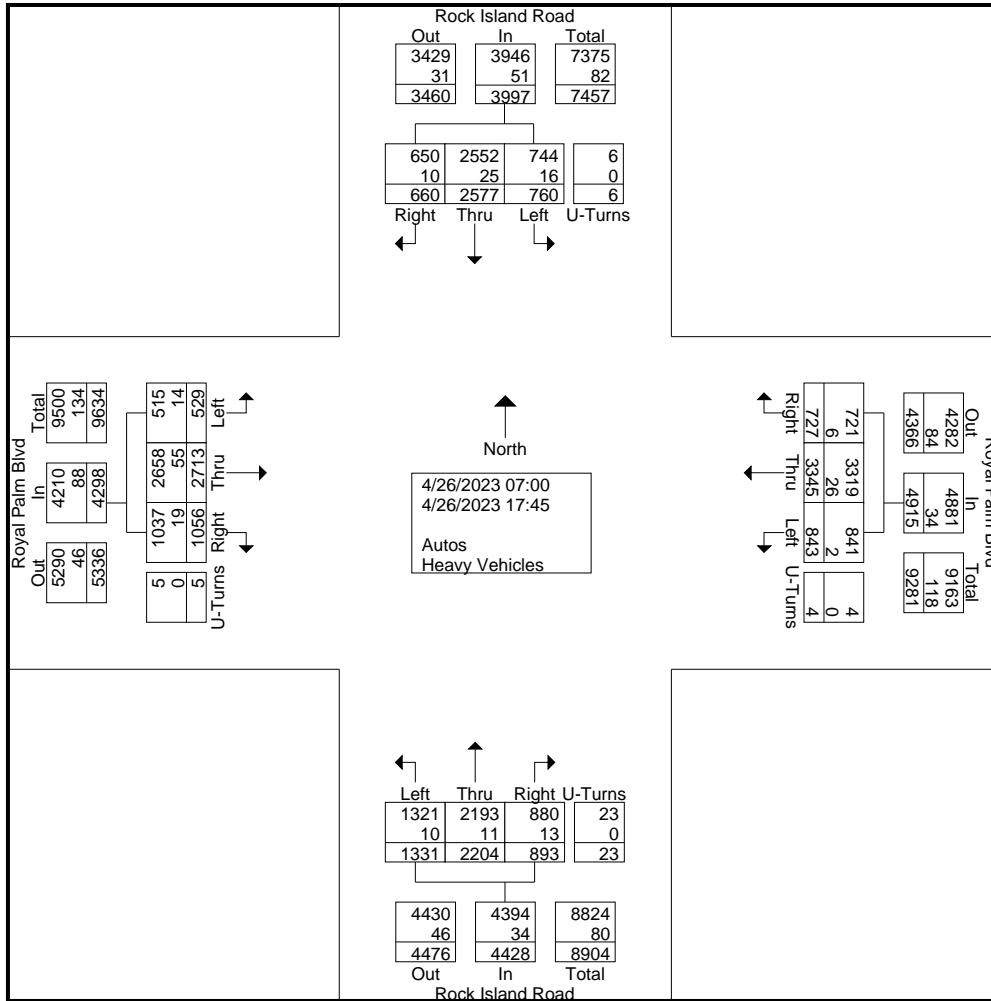

Traf Tech Engineering Inc.

File Name : 1- Rock Island Rd & Royal Palm Blvd
 Site Code : 00000000
 Start Date : 4/26/2023
 Page No : 3

Start Time	Rock Island Road Southbound					Royal Palm Blvd Westbound					Rock Island Road Northbound					Royal Palm Blvd Eastbound					Int. Total
	Right	Thru	Left	U-Turns	App. Total	Right	Thru	Left	U-Turns	App. Total	Right	Thru	Left	U-Turns	App. Total	Right	Thru	Left	U-Turns	App. Total	
Peak Hour Analysis From 07:00 to 17:45 - Peak 1 of 1																					
Peak Hour for Entire Intersection Begins at 07:30																					
07:30	45	181	75	0	301	57	192	32	0	281	55	153	78	2	288	109	265	44	0	418	1288
07:45	41	153	58	1	253	56	198	39	0	293	58	139	111	0	308	88	227	41	1	357	1211
08:00	36	170	42	0	248	39	168	51	0	258	53	153	94	0	300	83	192	23	0	298	1104
08:15	44	158	46	0	248	33	198	35	0	266	61	140	80	0	281	85	224	40	0	349	1144
Total Volume	166	662	221	1	1050	185	756	157	0	1098	227	585	363	2	1177	365	908	148	1	1422	4747
% App. Total	15.8	63	21	0.1		16.8	68.9	14.3	0		19.3	49.7	30.8	0.2		25.7	63.9	10.4	0.1		
PHF	.922	.914	.737	.250	.872	.811	.955	.770	.000	.937	.930	.956	.818	.250	.955	.837	.857	.841	.250	.850	.921
Autos	161	653	218	1	1033	185	749	155	0	1089	225	583	360	2	1170	361	897	143	1	1402	4694
% Autos	97.0	98.6	98.6	100	98.4	100	99.1	98.7	0	99.2	99.1	99.7	99.2	100	99.4	98.9	98.8	96.6	100	98.6	98.9
Heavy Vehicles																					
% Heavy Vehicles	3.0	1.4	1.4	0	1.6	0	0.9	1.3	0	0.8	0.9	0.3	0.8	0	0.6	1.1	1.2	3.4	0	1.4	1.1

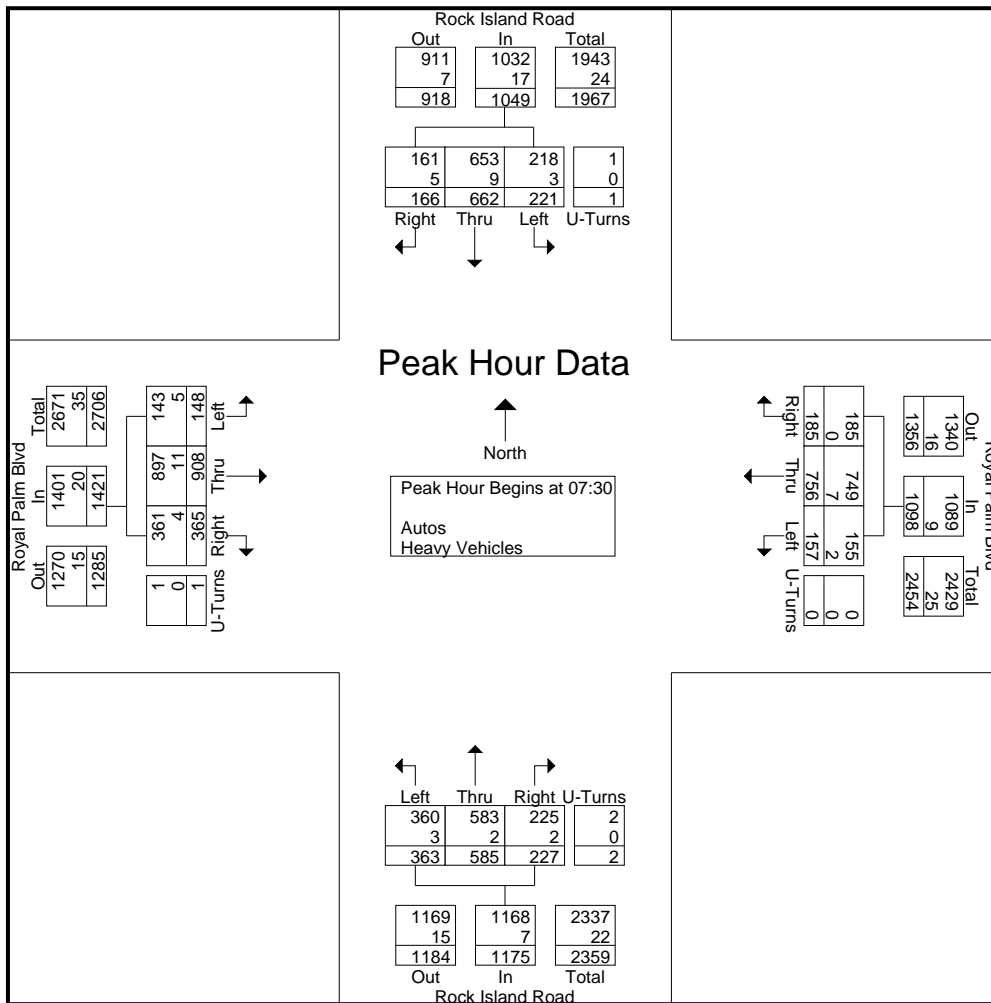

Traf Tech Engineering Inc.

File Name : 1- Rock Island Rd & Royal Palm Blvd
 Site Code : 00000000
 Start Date : 4/26/2023
 Page No : 4

Start Time	Rock Island Road Southbound					Royal Palm Blvd Westbound					Rock Island Road Northbound					Royal Palm Blvd Eastbound					Int. Total
	Right	Thru	Left	U-Turns	App. Total	Right	Thru	Left	U-Turns	App. Total	Right	Thru	Left	U-Turns	App. Total	Right	Thru	Left	U-Turns	App. Total	
Peak Hour Analysis From 07:00 to 08:45 - Peak 1 of 1																					
Peak Hour for Entire Intersection Begins at 07:30																					
07:30	45	181	75	0	301	57	192	32	0	281	55	153	78	2	288	109	265	44	0	418	1288
07:45	41	153	58	1	253	56	198	39	0	293	58	139	111	0	308	88	227	41	1	357	1211
08:00	36	170	42	0	248	39	168	51	0	258	53	153	94	0	300	83	192	23	0	298	1104
08:15	44	158	46	0	248	33	198	35	0	266	61	140	80	0	281	85	224	40	0	349	1144
Total Volume	166	662	221	1	1050	185	756	157	0	1098	227	585	363	2	1177	365	908	148	1	1422	4747
% App. Total	15.8	63	21	0.1		16.8	68.9	14.3	0		19.3	49.7	30.8	0.2		25.7	63.9	10.4	0.1		
PHF	.922	.914	.737	.250	.872	.811	.955	.770	.000	.937	.930	.956	.818	.250	.955	.837	.857	.841	.250	.850	.921
Autos	161	653	218	1	1033	185	749	155	0	1089	225	583	360	2	1170	361	897	143	1	1402	4694
% Autos	97.0	98.6	98.6	100	98.4	100	99.1	98.7	0	99.2	99.1	99.7	99.2	100	99.4	98.9	98.8	96.6	100	98.6	98.9
Heavy Vehicles																					
% Heavy Vehicles	3.0	1.4	1.4	0	1.6	0	0.9	1.3	0	0.8	0.9	0.3	0.8	0	0.6	1.1	1.2	3.4	0	1.4	1.1

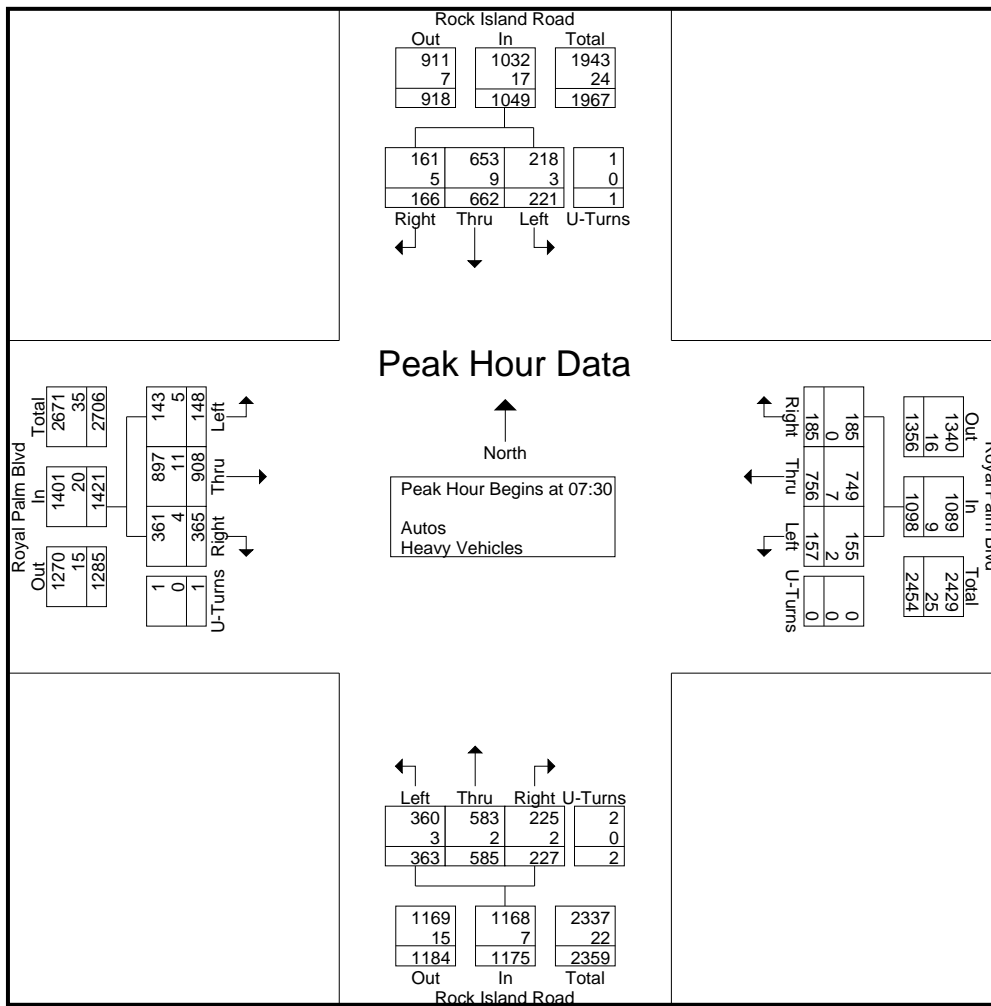

Traf Tech Engineering Inc.

File Name : 1- Rock Island Rd & Royal Palm Blvd
 Site Code : 00000000
 Start Date : 4/26/2023
 Page No : 5

Start Time	Rock Island Road Southbound					Royal Palm Blvd Westbound					Rock Island Road Northbound					Royal Palm Blvd Eastbound					Int. Total
	Right	Thru	Left	U-Turns	App. Total	Right	Thru	Left	U-Turns	App. Total	Right	Thru	Left	U-Turns	App. Total	Right	Thru	Left	U-Turns	App. Total	
Peak Hour Analysis From 16:00 to 17:45 - Peak 1 of 1																					
Peak Hour for Entire Intersection Begins at 17:00																					
17:00	43	172	50	3	268	51	224	63	1	339	57	145	69	4	275	42	137	30	0	209	1091
17:15	36	171	34	0	241	64	226	82	0	372	61	151	91	0	303	60	155	37	0	252	1168
17:30	49	198	47	0	294	47	235	56	0	338	49	151	93	4	297	56	111	32	1	200	1129
17:45	40	163	53	0	256	54	222	64	0	340	73	152	72	5	302	50	123	28	0	201	1099
Total Volume	168	704	184	3	1059	216	907	265	1	1389	240	599	325	13	1177	208	526	127	1	862	4487
% App. Total	15.9	66.5	17.4	0.3		15.6	65.3	19.1	0.1		20.4	50.9	27.6	1.1		24.1	61	14.7	0.1		
PHF	.857	.889	.868	.250	.901	.844	.965	.808	.250	.933	.822	.985	.874	.650	.971	.867	.848	.858	.250	.855	.960
Autos	168	698	182	3	1051	216	906	265	1	1388	238	597	322	13	1170	206	514	126	1	847	4456
% Autos	100	99.1	98.9	100	99.2	100	99.9				99.2	99.7	99.1	100	99.4	99.0	97.7	99.2	100	98.3	99.3
Heavy Vehicles																					
% Heavy Vehicles	0	0.9	1.1	0	0.8	0	0.1	0	0	0.1	0.8	0.3	0.9	0	0.6	1.0	2.3	0.8	0	1.7	0.7

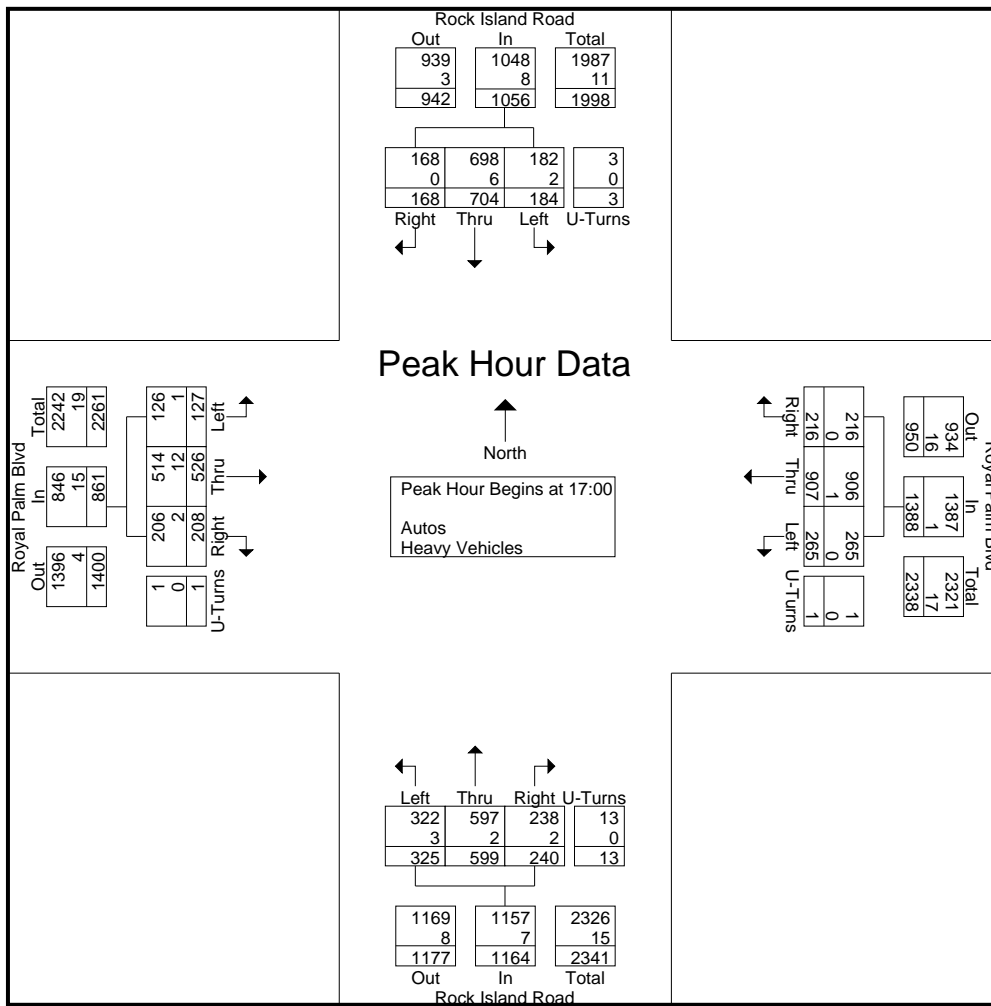

Traf Tech Engineering Inc.

File Name : 2-NW 66th Ave & Margate Blvd

Site Code : 00000000

Start Date : 4/26/2023

Page No : 1

Groups Printed- Peds & Bikes

Start Time	NW 66th Ave Southbound				Margate Blvd Westbound				NW 66th Ave Northbound				Margate Blvd Eastbound				Int. Total
	Bikes			Peds	Bikes			Peds	Bikes			Peds	Bikes			Peds	
07:00	0	0	0	0	0	0	0	0	0	0	0	1	0	0	0	0	1
07:15	0	0	0	2	0	0	0	0	0	0	0	0	3	0	0	0	5
*** BREAK ***																	
07:45	0	0	0	1	1	0	0	1	0	0	0	0	0	0	0	0	3
Total	0	0	0	3	1	0	0	1	0	0	0	1	3	0	0	0	9
08:00	0	0	0	0	0	0	0	1	0	0	0	0	0	0	0	0	1
08:15	0	0	0	0	0	0	0	0	1	0	0	0	0	0	0	0	1
08:30	0	0	0	0	0	0	0	0	0	0	0	1	0	0	0	0	1
08:45	0	0	0	1	0	0	0	0	0	0	0	0	0	0	0	0	1
Total	0	0	0	1	0	0	0	1	1	0	0	1	0	0	0	0	4
*** BREAK ***																	
16:00	0	0	0	0	0	0	0	6	0	0	0	0	0	0	0	0	6
16:15	2	0	0	0	0	0	0	0	0	0	0	0	0	0	0	1	3
16:30	0	0	0	0	0	0	0	0	0	0	0	0	1	0	0	0	1
16:45	0	0	0	0	0	0	0	1	0	0	0	0	1	0	0	0	2
Total	2	0	0	0	0	0	0	7	0	0	0	0	2	0	0	1	12
17:00	0	0	0	0	0	0	0	0	0	0	0	1	0	0	0	0	1
*** BREAK ***																	
17:45	0	0	0	0	0	0	0	0	0	0	0	1	0	0	0	0	1
Total	0	0	0	0	0	0	0	0	0	0	0	2	0	0	0	0	2
Grand Total	2	0	0	4	1	0	0	9	1	0	0	4	5	0	0	1	27
Apprch %	33.3	0	0	66.7	10	0	0	90	20	0	0	80	83.3	0	0	16.7	
Total %	7.4	0	0	14.8	3.7	0	0	33.3	3.7	0	0	14.8	18.5	0	0	3.7	

Traf Tech Engineering Inc.

File Name : 2-NW 66th Ave & Margate Blvd

Site Code : 00000000

Start Date : 4/26/2023

Page No : 1

Groups Printed- Autos - Heavy Vehicles

Start Time	NW 66th Ave Southbound					Margate Blvd Westbound					NW 66th Ave Northbound					Margate Blvd Eastbound					Int. Total
	Right	Thru	Left	U-Turns	App. Total	Right	Thru	Left	U-Turns	App. Total	Right	Thru	Left	U-Turns	App. Total	Right	Thru	Left	U-Turns	App. Total	
07:00	11	11	4	0	26	0	17	1	0	18	10	14	6	0	30	12	68	9	1	90	164
07:15	12	16	6	1	35	8	27	4	0	39	7	10	15	0	32	13	94	23	0	130	236
07:30	18	16	12	2	48	2	30	1	2	35	20	21	8	0	49	19	138	20	1	178	310
07:45	16	17	11	0	44	3	32	6	1	42	19	15	5	0	39	7	127	30	0	164	289
Total	57	60	33	3	153	13	106	12	3	134	56	60	34	0	150	51	427	82	2	562	999
08:00	14	19	8	1	42	4	35	7	1	47	14	6	7	0	27	17	102	12	1	132	248
08:15	7	9	1	0	17	2	23	9	1	35	7	10	12	0	29	10	84	6	0	100	181
08:30	13	20	1	0	34	1	25	9	0	35	13	6	13	0	32	9	66	4	0	79	180
08:45	11	17	3	0	31	1	26	2	0	29	17	16	8	0	41	17	66	6	0	89	190
Total	45	65	13	1	124	8	109	27	2	146	51	38	40	0	129	53	318	28	1	400	799
*** BREAK ***																					
16:00	14	21	2	1	38	5	79	6	1	91	14	17	15	0	46	12	56	12	0	80	255
16:15	10	10	2	0	22	6	69	8	0	83	9	13	8	0	30	6	42	12	1	61	196
16:30	14	13	1	0	28	3	63	7	0	73	11	15	13	0	39	13	33	6	0	52	192
16:45	12	9	3	0	24	2	79	11	0	92	8	19	20	0	47	10	55	13	0	78	241
Total	50	53	8	1	112	16	290	32	1	339	42	64	56	0	162	41	186	43	1	271	884
17:00	13	19	3	0	35	11	94	5	2	112	15	23	18	0	56	12	50	11	0	73	276
17:15	19	20	3	0	42	4	93	15	0	112	12	16	12	0	40	19	47	10	0	76	270
17:30	17	24	3	0	44	9	109	8	0	126	12	17	10	0	39	12	37	13	0	62	271
17:45	12	21	2	0	35	3	66	16	1	86	5	20	11	0	36	20	34	16	0	70	227
Total	61	84	11	0	156	27	362	44	3	436	44	76	51	0	171	63	168	50	0	281	1044
Grand Total	213	262	65	5	545	64	867	115	9	1055	193	238	181	0	612	208	1099	203	4	1514	3726
Apprch %	39.1	48.1	11.9	0.9		6.1	82.2	10.9	0.9		31.5	38.9	29.6	0		13.7	72.6	13.4	0.3		
Total %	5.7	7	1.7	0.1	14.6	1.7	23.3	3.1	0.2	28.3	5.2	6.4	4.9	0	16.4	5.6	29.5	5.4	0.1	40.6	
Autos	210	257	65	5	537	63	855	113	9	1040	187	237	176	0	600	207	1092	198	4	1501	3678
% Autos	98.6	98.1	100	100	98.5	98.4	98.6	98.3	100	98.6	96.9	99.6	97.2	0	98	99.5	99.4	97.5	100	99.1	98.7
Heavy Vehicles																					
% Heavy Vehicles	1.4	1.9	0	0	1.5	1.6	1.4	1.7	0	1.4	3.1	0.4	2.8	0	2	0.5	0.6	2.5	0	0.9	1.3

Traf Tech Engineering Inc.

File Name : 2-NW 66th Ave & Margate Blvd

Site Code : 00000000

Start Date : 4/26/2023

Page No : 2

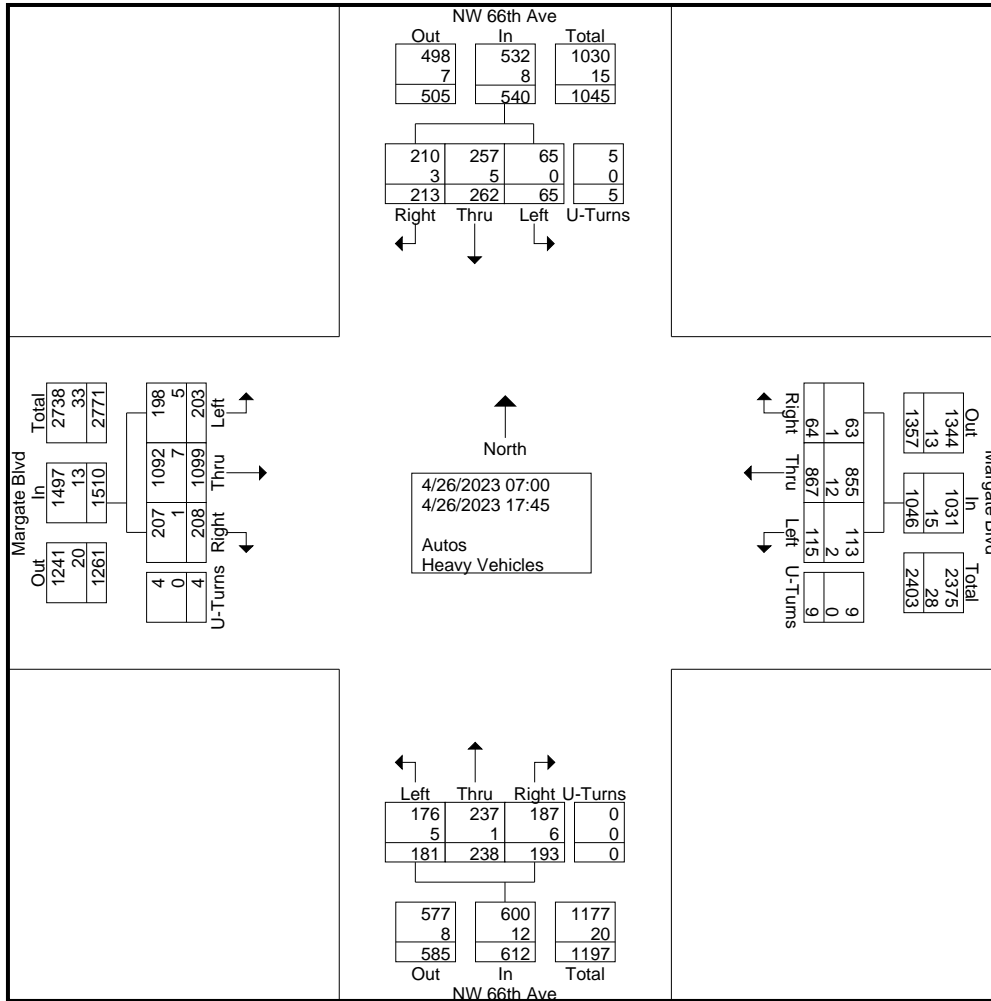

Traf Tech Engineering Inc.

File Name : 2-NW 66th Ave & Margate Blvd
 Site Code : 00000000
 Start Date : 4/26/2023
 Page No : 3

Start Time	NW 66th Ave Southbound					Margate Blvd Westbound					NW 66th Ave Northbound					Margate Blvd Eastbound					Int. Total
	Right	Thru	Left	U-Turns	App. Total	Right	Thru	Left	U-Turns	App. Total	Right	Thru	Left	U-Turns	App. Total	Right	Thru	Left	U-Turns	App. Total	
Peak Hour Analysis From 07:00 to 17:45 - Peak 1 of 1																					
Peak Hour for Entire Intersection Begins at 07:15																					
07:15	12	16	6	1	35	8	27	4	0	39	7	10	15	0	32	13	94	23	0	130	236
07:30	18	16	12	2	48	2	30	1	2	35	20	21	8	0	49	19	138	20	1	178	310
07:45	16	17	11	0	44	3	32	6	1	42	19	15	5	0	39	7	127	30	0	164	289
08:00	14	19	8	1	42	4	35	7	1	47	14	6	7	0	27	17	102	12	1	132	248
Total Volume	60	68	37	4	169	17	124	18	4	163	60	52	35	0	147	56	461	85	2	604	1083
% App. Total	35.5	40.2	21.9	2.4		10.4	76.1	11	2.5		40.8	35.4	23.8	0		9.3	76.3	14.1	0.3		
PHF	.833	.895	.771	.500	.880	.531	.886	.643	.500	.867	.750	.619	.583	.000	.750	.737	.835	.708	.500	.848	.873
Autos	59	68	37	4	168	17	120	18	4	159	56	52	35	0	143	56	459	84	2	601	1071
% Autos	98.3	100	100	100	99.4	100	96.8				93.3	100	100	0	97.3	100	99.6	98.8	100	99.5	98.9
Heavy Vehicles																					
% Heavy Vehicles	1.7	0	0	0	0.6	0	3.2	0	0	2.5	6.7	0	0	0	2.7	0	0.4	1.2	0	0.5	1.1

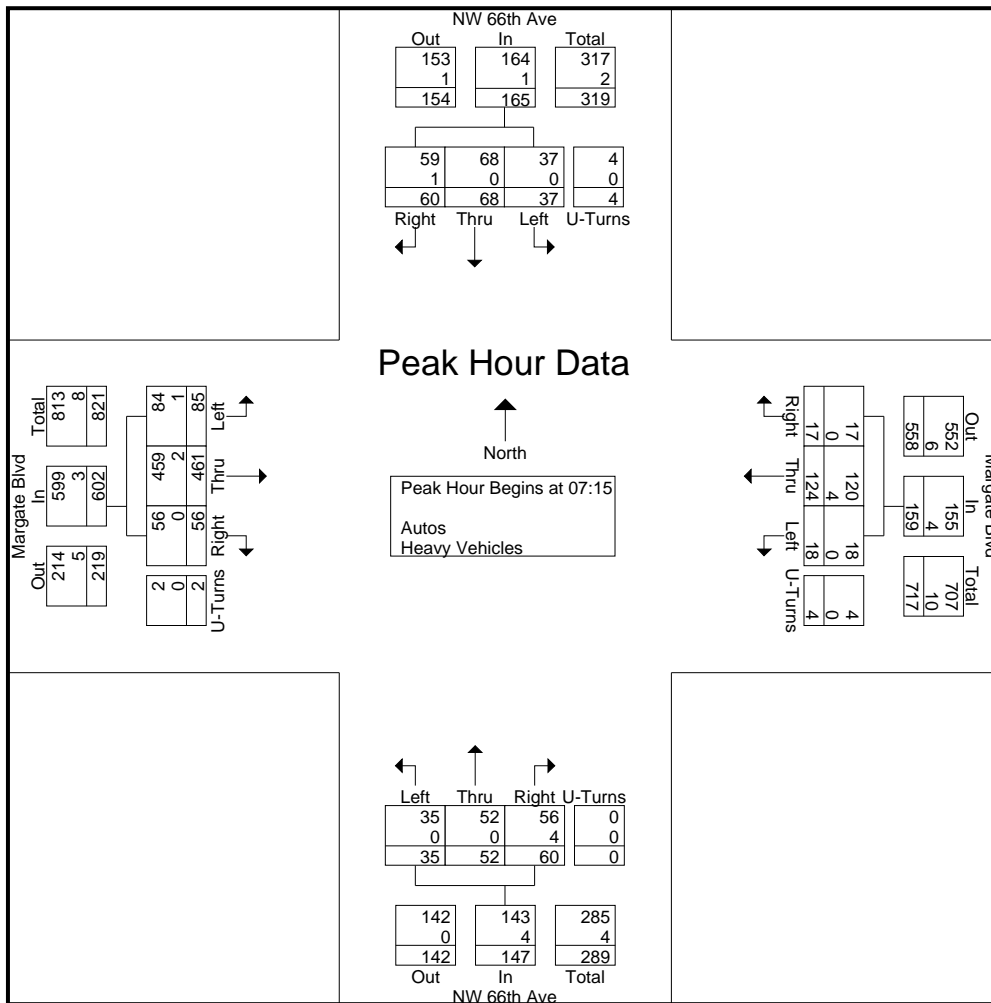

Traf Tech Engineering Inc.

File Name : 2-NW 66th Ave & Margate Blvd

Site Code : 00000000

Start Date : 4/26/2023

Page No : 4

Start Time	NW 66th Ave Southbound					Margate Blvd Westbound					NW 66th Ave Northbound					Margate Blvd Eastbound					Int. Total
	Right	Thru	Left	U-Turns	App. Total	Right	Thru	Left	U-Turns	App. Total	Right	Thru	Left	U-Turns	App. Total	Right	Thru	Left	U-Turns	App. Total	
Peak Hour Analysis From 07:00 to 08:45 - Peak 1 of 1																					
Peak Hour for Entire Intersection Begins at 07:15																					
07:15	12	16	6	1	35	8	27	4	0	39	7	10	15	0	32	13	94	23	0	130	236
07:30	18	16	12	2	48	2	30	1	2	35	20	21	8	0	49	19	138	20	1	178	310
07:45	16	17	11	0	44	3	32	6	1	42	19	15	5	0	39	7	127	30	0	164	289
08:00	14	19	8	1	42	4	35	7	1	47	14	6	7	0	27	17	102	12	1	132	248
Total Volume	60	68	37	4	169	17	124	18	4	163	60	52	35	0	147	56	461	85	2	604	1083
% App. Total	35.5	40.2	21.9	2.4		10.4	76.1	11	2.5		40.8	35.4	23.8	0		9.3	76.3	14.1	0.3		
PHF	.833	.895	.771	.500	.880	.531	.886	.643	.500	.867	.750	.619	.583	.000	.750	.737	.835	.708	.500	.848	.873
Autos	59	68	37	4	168	17	120	18	4	159	56	52	35	0	143	56	459	84	2	601	1071
% Autos	98.3	100	100	100	99.4	100	96.8				93.3	100	100	0	97.3	100	99.6	98.8	100	99.5	98.9
Heavy Vehicles																					
% Heavy Vehicles	1.7	0	0	0	0.6	0	3.2	0	0	2.5	6.7	0	0	0	2.7	0	0.4	1.2	0	0.5	1.1

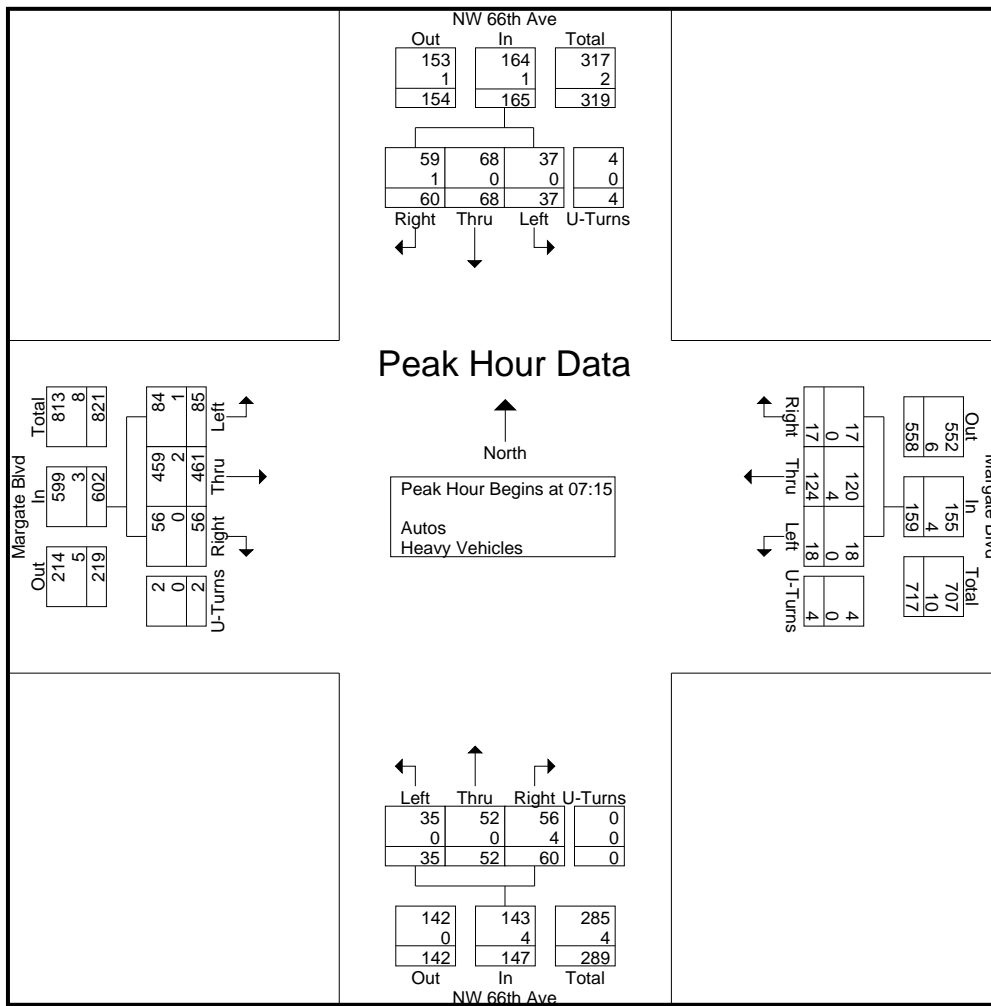

Traf Tech Engineering Inc.

File Name : 2-NW 66th Ave & Margate Blvd
 Site Code : 00000000
 Start Date : 4/26/2023
 Page No : 5

Start Time	NW 66th Ave Southbound					Margate Blvd Westbound					NW 66th Ave Northbound					Margate Blvd Eastbound					Int. Total
	Right	Thru	Left	U-Turns	App. Total	Right	Thru	Left	U-Turns	App. Total	Right	Thru	Left	U-Turns	App. Total	Right	Thru	Left	U-Turns	App. Total	
Peak Hour Analysis From 16:00 to 17:45 - Peak 1 of 1																					
Peak Hour for Entire Intersection Begins at 16:45																					
16:45	12	9	3	0	24	2	79	11	0	92	8	19	20	0	47	10	55	13	0	78	241
17:00	13	19	3	0	35	11	94	5	2	112	15	23	18	0	56	12	50	11	0	73	276
17:15	19	20	3	0	42	4	93	15	0	112	12	16	12	0	40	19	47	10	0	76	270
17:30	17	24	3	0	44	9	109	8	0	126	12	17	10	0	39	12	37	13	0	62	271
Total Volume	61	72	12	0	145	26	375	39	2	442	47	75	60	0	182	53	189	47	0	289	1058
% App. Total	42.1	49.7	8.3	0		5.9	84.8	8.8	0.5		25.8	41.2	33	0		18.3	65.4	16.3	0		
PHF	.803	.750		.000	.824	.591	.860	.650	.250	.877	.783	.815	.750	.000	.813	.697	.859	.904	.000	.926	.958
Autos	61	72	12	0	145	26	374	39	2	441	46	75	59	0	180	53	186	47	0	286	1052
% Autos	100	100	100	0	100	100	99.7				97.9	100	98.3	0	98.9	100	98.4				
Heavy Vehicles	0	0	0	0	0	0	1	0	0	1	1	0	1	0	2	0	3	0	0	3	6
% Heavy Vehicles	0	0	0	0	0	0	0.3	0	0	0.2	2.1	0	1.7	0	1.1	0	1.6	0	0	1.0	0.6

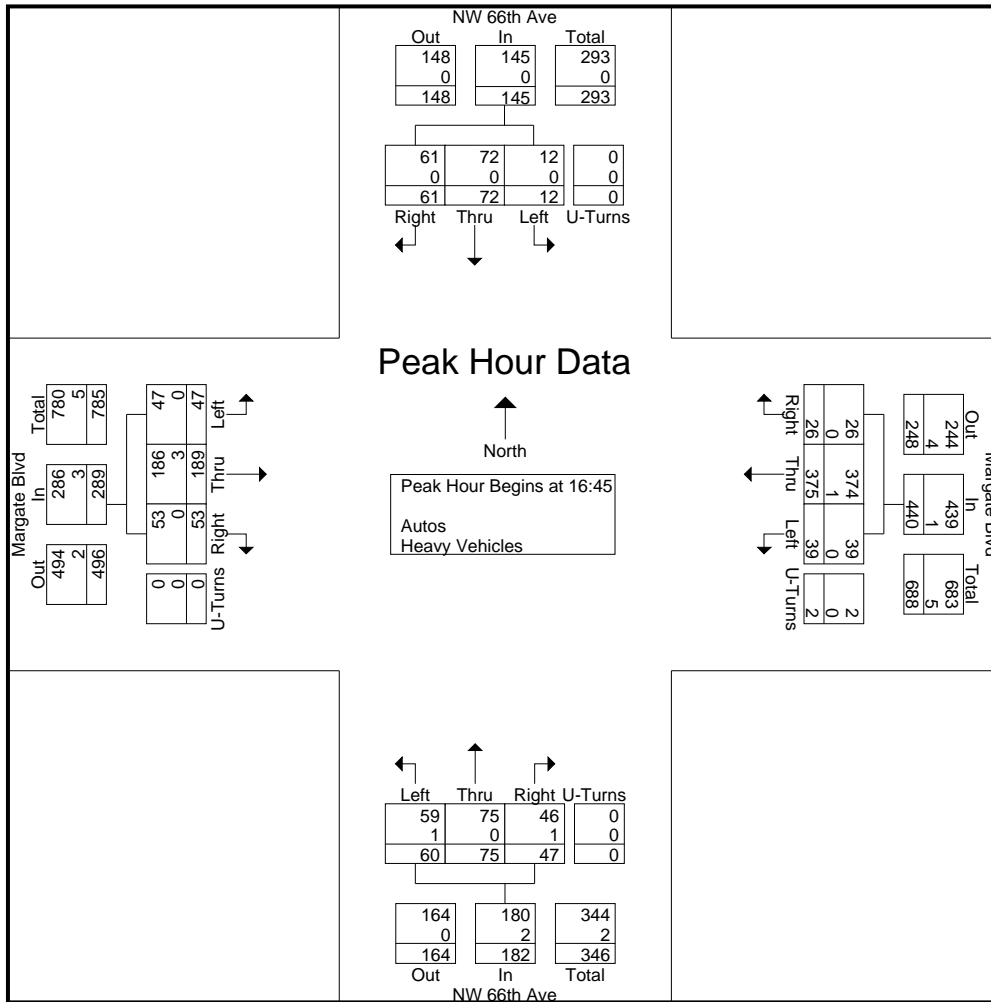

Traf Tech Engineering Inc.

File Name : 3-NW 66th Ave & Atlantic Blvd

Site Code : 00000000

Start Date : 4/26/2023

Page No : 1

Groups Printed- Autos - Heavy Vehicles

Start Time	NW 66th Ave Southbound					Atlantic Blvd Westbound					NW 66th Ave Northbound					Atlantic Blvd Eastbound					Int. Total
	Right	Thru	Left	U-Turns	App. Total	Right	Thru	Left	U-Turns	App. Total	Right	Thru	Left	U-Turns	App. Total	Right	Thru	Left	U-Turns	App. Total	
07:00	20	1	30	1	52	13	168	0	0	181	8	3	10	0	21	4	406	10	5	425	679
07:15	23	4	27	0	54	13	201	3	0	217	8	5	15	0	28	7	486	14	7	514	813
07:30	24	6	30	0	60	24	210	3	0	237	15	10	26	0	51	8	449	24	6	487	835
07:45	24	2	31	0	57	17	173	2	1	193	7	3	11	0	21	6	385	28	9	428	699
Total	91	13	118	1	223	67	752	8	1	828	38	21	62	0	121	25	1726	76	27	1854	3026
08:00	26	6	30	0	62	22	193	5	2	222	12	4	10	0	26	8	353	42	8	411	721
08:15	16	3	32	0	51	23	210	9	0	242	9	3	10	0	22	9	383	28	7	427	742
08:30	30	4	21	0	55	14	205	7	0	226	8	5	11	0	24	11	291	27	8	337	642
08:45	34	9	30	0	73	21	223	7	2	253	11	6	16	0	33	5	283	31	4	323	682
Total	106	22	113	0	241	80	831	28	4	943	40	18	47	0	105	33	1310	128	27	1498	2787
*** BREAK ***																					
16:00	42	9	41	0	92	32	325	6	4	367	7	8	18	0	33	9	265	30	3	307	799
16:15	33	9	18	0	60	36	421	8	4	469	13	5	19	0	37	16	252	24	7	299	865
16:30	22	7	23	0	52	34	437	12	3	486	11	8	22	0	41	5	272	16	4	297	876
16:45	26	2	21	0	49	42	407	11	5	465	13	2	21	0	36	9	263	23	6	301	851
Total	123	27	103	0	253	144	1590	37	16	1787	44	23	80	0	147	39	1052	93	20	1204	3391
17:00	38	5	42	0	85	32	469	14	2	517	9	6	17	0	32	18	295	28	6	347	981
17:15	31	7	16	0	54	37	475	6	2	520	8	3	14	0	25	10	261	25	8	304	903
17:30	22	6	31	0	59	38	493	5	6	542	8	2	15	0	25	17	304	23	8	352	978
17:45	34	9	38	0	81	39	460	19	4	522	16	4	17	0	37	10	334	21	5	370	1010
Total	125	27	127	0	279	146	1897	44	14	2101	41	15	63	0	119	55	1194	97	27	1373	3872
Grand Total	445	89	461	1	996	437	5070	117	35	5659	163	77	252	0	492	152	5282	394	101	5929	13076
Apprch %	44.7	8.9	46.3	0.1		7.7	89.6	2.1	0.6		33.1	15.7	51.2	0		2.6	89.1	6.6	1.7		
Total %	3.4	0.7	3.5	0	7.6	3.3	38.8	0.9	0.3	43.3	1.2	0.6	1.9	0	3.8	1.2	40.4	3	0.8	45.3	
Autos	440	89	454	1	984	434	5009	116	35	5594	160	76	252	0	488	152	5213	388	101	5854	12920
% Autos	98.9	100	98.5	100	98.8	99.3	98.8	99.1	100	98.9	98.2	98.7	100	0	99.2	100	98.7	98.5	100	98.7	98.8
Heavy Vehicles																					
% Heavy Vehicles	1.1	0	1.5	0	1.2	0.7	1.2	0.9	0	1.1	1.8	1.3	0	0	0.8	0	1.3	1.5	0	1.3	1.2

Traf Tech Engineering Inc.

File Name : 3-NW 66th Ave & Atlantic Blvd

Site Code : 00000000

Start Date : 4/26/2023

Page No : 2

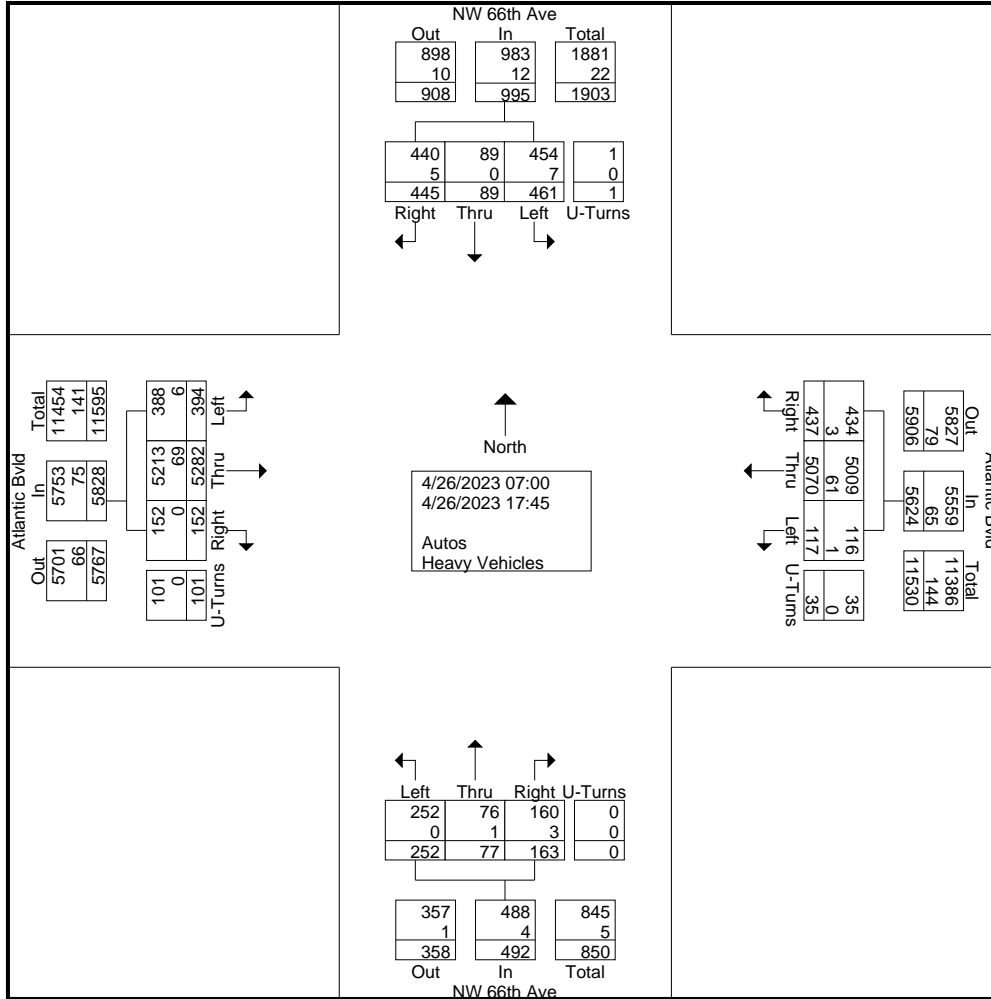

Traf Tech Engineering Inc.

File Name : 3-NW 66th Ave & Atlantic Blvd
 Site Code : 00000000
 Start Date : 4/26/2023
 Page No : 3

Start Time	NW 66th Ave Southbound					Atlantic Blvd Westbound					NW 66th Ave Northbound					Atlantic Blvd Eastbound					Int. Total
	Right	Thru	Left	U-Turns	App. Total	Right	Thru	Left	U-Turns	App. Total	Right	Thru	Left	U-Turns	App. Total	Right	Thru	Left	U-Turns	App. Total	
Peak Hour Analysis From 07:00 to 17:45 - Peak 1 of 1																					
Peak Hour for Entire Intersection Begins at 17:00																					
17:00	38	5	42	0	85	32	469	14	2	517	9	6	17	0	32	18	295	28	6	347	981
17:15	31	7	16	0	54	37	475	6	2	520	8	3	14	0	25	10	261	25	8	304	903
17:30	22	6	31	0	59	38	493	5	6	542	8	2	15	0	25	17	304	23	8	352	978
17:45	34	9	38	0	81	39	460	19	4	522	16	4	17	0	37	10	334	21	5	370	1010
Total Volume	125	27	127	0	279	146	1897	44	14	2101	41	15	63	0	119	55	1194	97	27	1373	3872
% App. Total	44.8	9.7	45.5	0		6.9	90.3	2.1	0.7		34.5	12.6	52.9	0		4	87	7.1	2		
PHF	.822	.750	.756	.000	.821	.936	.962	.579	.583	.969	.641	.625	.926	.000	.804	.764	.894	.866	.844	.928	.958
Autos	125	27	125	0	277	144	1886									1174					
% Autos	100	100	98.4	0	99.3	98.6	99.4	100	100	99.4	97.6	100	100	0	99.2	100	98.3	97.9	100	98.4	99.0
Heavy Vehicles																					
% Heavy Vehicles	0	0	1.6	0	0.7	1.4	0.6	0	0	0.6	2.4	0	0	0.8	0	1.7	2.1	0	1.6	1.0	

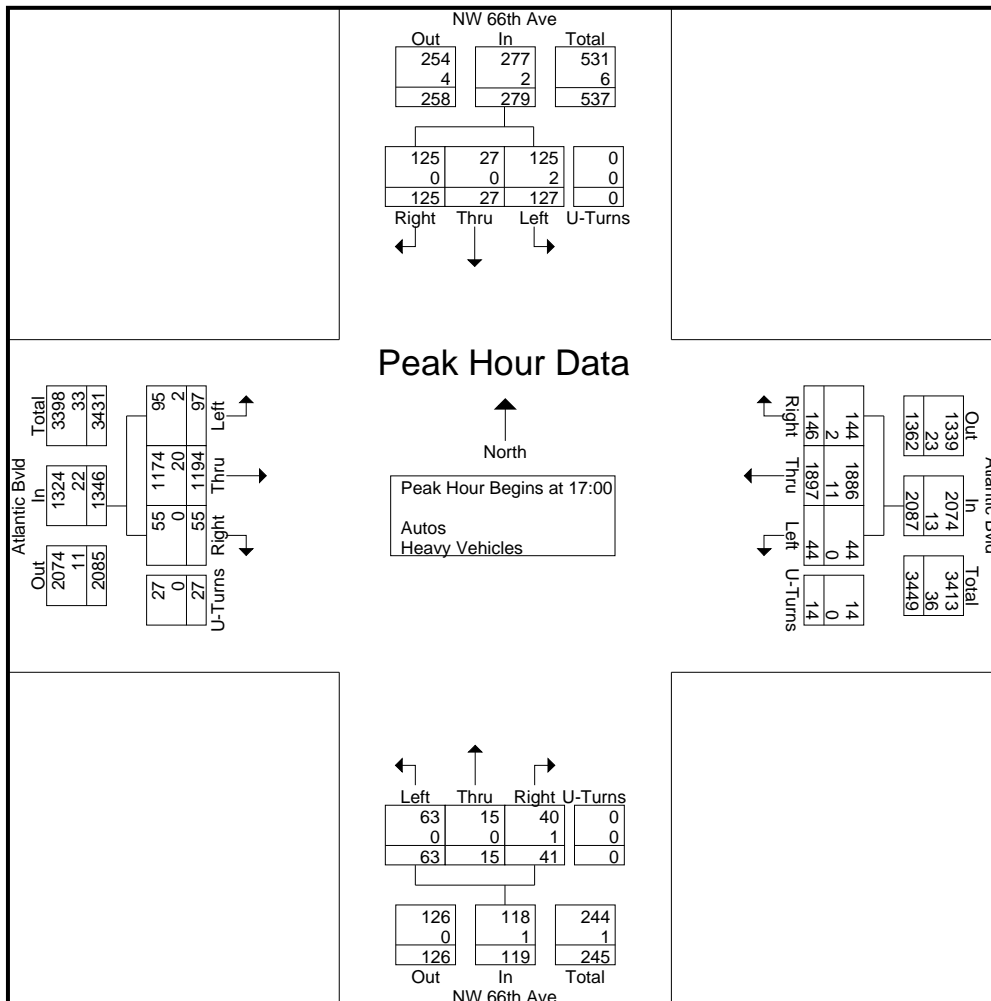

Traf Tech Engineering Inc.

File Name : 3-NW 66th Ave & Atlantic Blvd
 Site Code : 00000000
 Start Date : 4/26/2023
 Page No : 4

Start Time	NW 66th Ave Southbound					Atlantic Blvd Westbound					NW 66th Ave Northbound					Atlantic Blvd Eastbound					Int. Total
	Right	Thru	Left	U-Turns	App. Total	Right	Thru	Left	U-Turns	App. Total	Right	Thru	Left	U-Turns	App. Total	Right	Thru	Left	U-Turns	App. Total	
Peak Hour Analysis From 07:00 to 08:45 - Peak 1 of 1																					
Peak Hour for Entire Intersection Begins at 07:15																					
07:15	23	4	27	0	54	13	201	3	0	217	8	5	15	0	28	7	486	14	7	514	813
07:30	24	6	30	0	60	24	210	3	0	237	15	10	26	0	51	8	449	24	6	487	835
07:45	24	2	31	0	57	17	173	2	1	193	7	3	11	0	21	6	385	28	9	428	699
08:00	26	6	30	0	62	22	193	5	2	222	12	4	10	0	26	8	353	42	8	411	721
Total Volume	97	18	118	0	233	76	777	13	3	869	42	22	62	0	126	29	1673	108	30	1840	3068
% App. Total	41.6	7.7	50.6	0		8.7	89.4	1.5	0.3		33.3	17.5	49.2	0		1.6	90.9	5.9	1.6		
PHF	.933	.750	.952	.000	.940	.792	.925	.650	.375	.917	.700	.550	.596	.000	.618	.906	.861	.643	.833	.895	.919
Autos	97	18	118	0	233	76	760	13	3	852	42	21	62	0	125	29	1660				
% Autos	100	100	100	0	100	100	97.8	100	100	98.0	100	95.5	100	0	99.2	100	99.2	100	100	99.3	99.0
Heavy Vehicles	0	0	0	0	0	0	17	0	0	17	0	1	0	0	1	0	13	0	0	13	31
% Heavy Vehicles	0	0	0	0	0	0	2.2	0	0	2.0	0	4.5	0	0	0.8	0	0.8	0	0	0.7	1.0

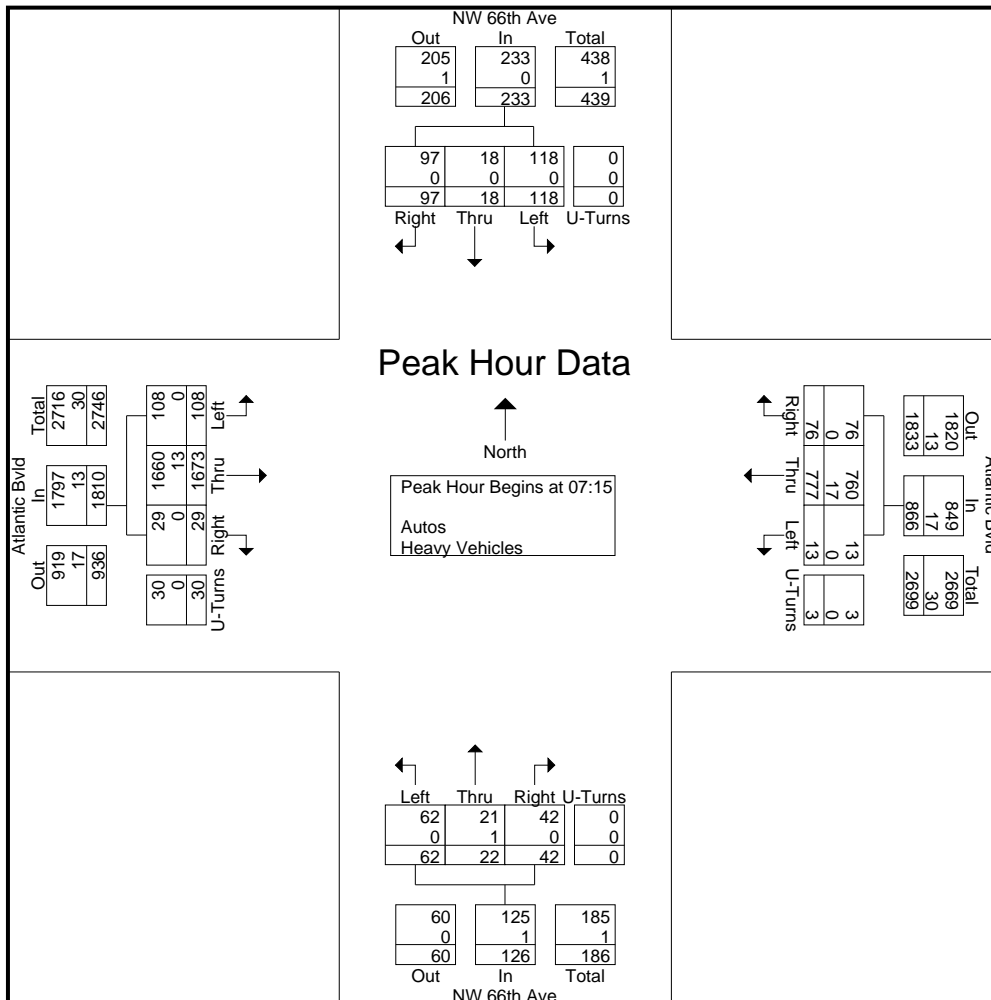

Traf Tech Engineering Inc.

File Name : 3-NW 66th Ave & Atlantic Blvd
 Site Code : 00000000
 Start Date : 4/26/2023
 Page No : 5

Start Time	NW 66th Ave Southbound					Atlantic Blvd Westbound					NW 66th Ave Northbound					Atlantic Blvd Eastbound					Int. Total
	Right	Thru	Left	U-Turns	App. Total	Right	Thru	Left	U-Turns	App. Total	Right	Thru	Left	U-Turns	App. Total	Right	Thru	Left	U-Turns	App. Total	
Peak Hour Analysis From 16:00 to 17:45 - Peak 1 of 1																					
Peak Hour for Entire Intersection Begins at 17:00																					
17:00	38	5	42	0	85	32	469	14	2	517	9	6	17	0	32	18	295	28	6	347	981
17:15	31	7	16	0	54	37	475	6	2	520	8	3	14	0	25	10	261	25	8	304	903
17:30	22	6	31	0	59	38	493	5	6	542	8	2	15	0	25	17	304	23	8	352	978
17:45	34	9	38	0	81	39	460	19	4	522	16	4	17	0	37	10	334	21	5	370	1010
Total Volume	125	27	127	0	279	146	1897	44	14	2101	41	15	63	0	119	55	1194	97	27	1373	3872
% App. Total	44.8	9.7	45.5	0		6.9	90.3	2.1	0.7		34.5	12.6	52.9	0		4	87	7.1	2		
PHF	.822	.750	.756	.000	.821	.936	.962	.579	.583	.969	.641	.625	.926	.000	.804	.764	.894	.866	.844	.928	.958
Autos	125	27	125	0	277	144	1886								1174						
% Autos	100	100	98.4	0	99.3	98.6	99.4	100	100	99.4	97.6	100	100	0	99.2	100	98.3	97.9	100	98.4	99.0
Heavy Vehicles																					
% Heavy Vehicles	0	0	1.6	0	0.7	1.4	0.6	0	0	0.6	2.4	0	0	0.8	0	1.7	2.1	0	1.6	1.0	

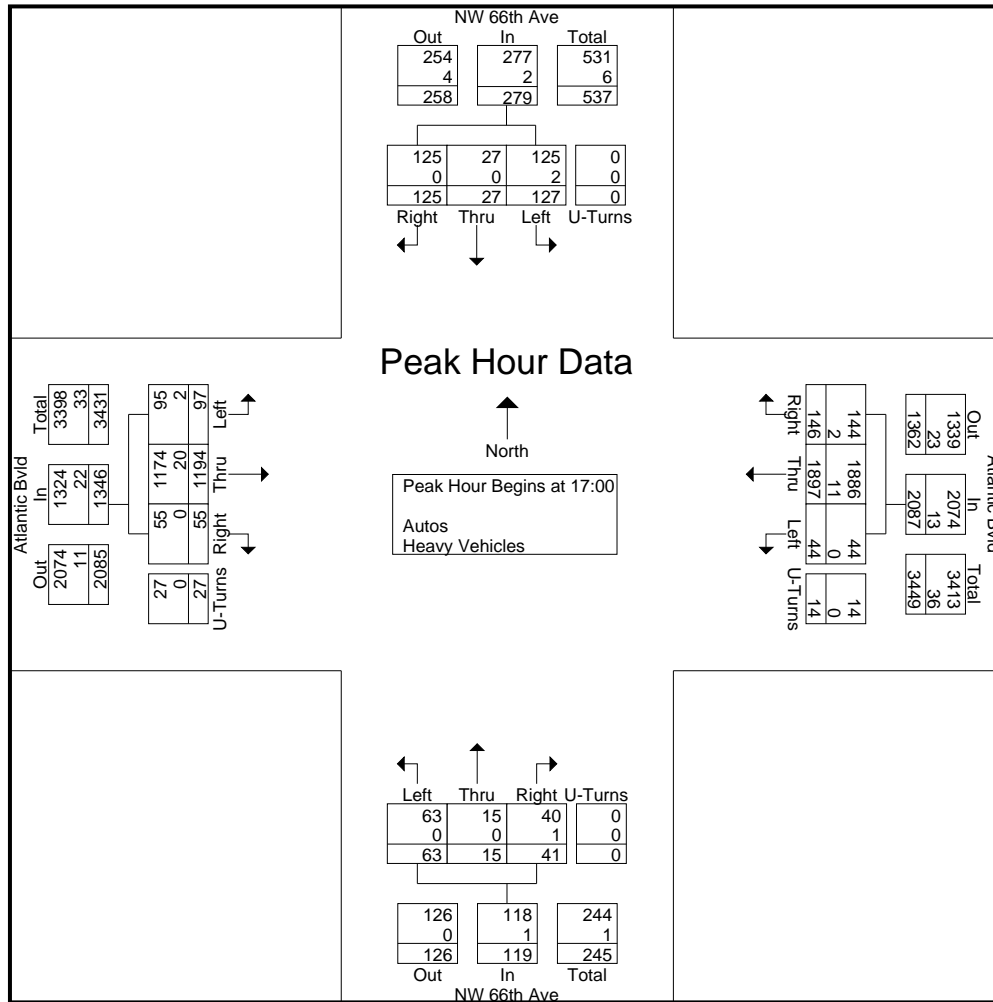

Station : 1056 - SR 7 & Atlantic Blvd (Standard File)

Phase	1 (SL)	2 (NT)	3 (WL)	4 (ET)	5 (NL)	6 (ST)	7 (EL)	8 (WT)	9	10	11	12	13	14	15	16
Walk		7		7		7		7								
Ped Clearance		36		33		36		30								
Min Green	5	8	4	6	5	8	4	6								
Gap Ext	1.5	3	1.5	2.5	1.5	3	1.5	2.5								
Max1	25	45	20	40	25	45	20	40								
Max2																
Yellow Clr	5	5	5	5	5	5	5	5	3.5	3.5	3.5	3.5	3.5	3.5	3.5	3.5
Red Clr	2	2	2	2	2	2	2	2	1.5	1.5	1.5	1.5	1.5	1.5	1.5	1.5
Red Revert																
Added Initial																
Max Initial																
Time Before Reduce																
Cars Before Reduce																
Time To Reduce																
Reduce By																
Min Gap																
Dynamic Max Limit																
Dynamic Max Step																
Enable	ON	ON	ON	ON	ON	ON	ON	ON								
Auto Flash Entry				ON				ON								
Auto Flash Exit		ON				ON										
Non-Actuated 1																
Non-Actuated 2																
Lock Call									ON	ON	ON	ON	ON	ON	ON	ON
Min Recall		ON				ON										
Max Recall																
Ped Recall																
Soft Recall																
Dual Entry				ON				ON								
Sim Gap Enable									ON	ON	ON	ON	ON	ON	ON	ON
Guar Passage																
Rest In Walk		ON				ON										
Cond Service																
Add Init Calc																

Preemption

Channel	1	2	3	4	5	6
Lock Input	ON	ON	ON	ON	ON	ON
Override Auto Flash				ON		
Override Higher Preempt				ON		
Flash in Dwell						
Link to Preempt						
Delay						
Min Duration						
Min Green	6	6	6	6	6	6
Min Walk						
Ped Clear						
Track Green						
Min Dwell	8	8	8	8	8	8
Max Presence	180	180	180	180	180	180
Track Veh 1						
Track Veh 2						
Track Veh 3						
Track Veh 4						
Dwell Cyc Veh 1	2	4	1	3	2	4
Dwell Cyc Veh 2	6	8	6	8	5	7
Dwell Cyc Veh 3						
Dwell Cyc Veh 4						
Dwell Cyc Veh 5						
Dwell Cyc Veh 6						

Preempt LP

Channel	1	2	3	4
Min				
Max				
Enable				
Lock Mode	MAX	MAX	MAX	MAX
Coord in Preempt				
No Skip				
Priority P1				
Priority P2				
Priority P3				
Priority P4				
Lock				
Headway				
Group Lock				
Queue Jump				
Free Mode				
Alt Table				

Station : 1159 - SR 7 & Margate Blvd (Standard File)

Phase	1 (SL)	2 (NT)	3 (WT)	4 (ET)	5 (NL)	6 (ST)	7	8	9	10	11	12	13	14	15	16
Walk		7		7		7										
Ped Clearance		30		31		26										
Min Green	4	12	5	7	4	12										
Gap Ext	1.5	3	2	2	1.5	3										
Max1	12	50	18	25	15	50										
Max2																
Yellow Clr	4	4	4	4	4	4	4	4	3.5	3.5	3.5	3.5	3.5	3.5	3.5	3.5
Red Clr	2	2	2.5	2.5	2	2			1.5	1.5	1.5	1.5	1.5	1.5	1.5	1.5
Red Revert																
Added Initial																
Max Initial																
Time Before Reduce																
Cars Before Reduce																
Time To Reduce																
Reduce By																
Min Gap																
Dynamic Max Limit																
Dynamic Max Step																
Enable	ON	ON	ON	ON	ON	ON										
Auto Flash Entry				ON												
Auto Flash Exit		ON				ON										
Non-Actuated 1																
Non-Actuated 2																
Lock Call									ON	ON	ON	ON	ON	ON	ON	ON
Min Recall		ON				ON										
Max Recall																
Ped Recall																
Soft Recall																
Dual Entry																
Sim Gap Enable									ON	ON	ON	ON	ON	ON	ON	ON
Guar Passage																
Rest In Walk		ON				ON										
Cond Service																
Add Init Calc																

Preemption

Channel	1	2	3	4	5	6
Lock Input	ON	ON	ON	ON	ON	ON
Override Auto Flash		ON		ON		
Override Higher Preempt		ON		ON		
Flash in Dwell		ON		ON		
Link to Preempt						
Delay						
Min Duration						
Min Green	6		6		6	6
Min Walk						
Ped Clear						
Track Green						
Min Dwell	8		8		8	8
Max Presence	180		180		180	180
Track Veh 1						
Track Veh 2						
Track Veh 3						
Track Veh 4						
Dwell Cyc Veh 1	2		1		2	4
Dwell Cyc Veh 2	6		6		5	
Dwell Cyc Veh 3						
Dwell Cyc Veh 4						
Dwell Cyc Veh 5						
Dwell Cyc Veh 6						

Preempt LP

Channel	1	2	3	4
Min				
Max				
Enable				
Lock Mode	MAX	MAX	MAX	MAX
Coord in Preempt				
No Skip				
Priority P1				
Priority P2				
Priority P3				
Priority P4				
Lock				
Headway				
Group Lock				
Queue Jump				
Free Mode				
Alt Table				

Sequence of Operation for (1177) Atlantic Blvd and Riverside Drive

Coral Springs

MOD 1 & Higher

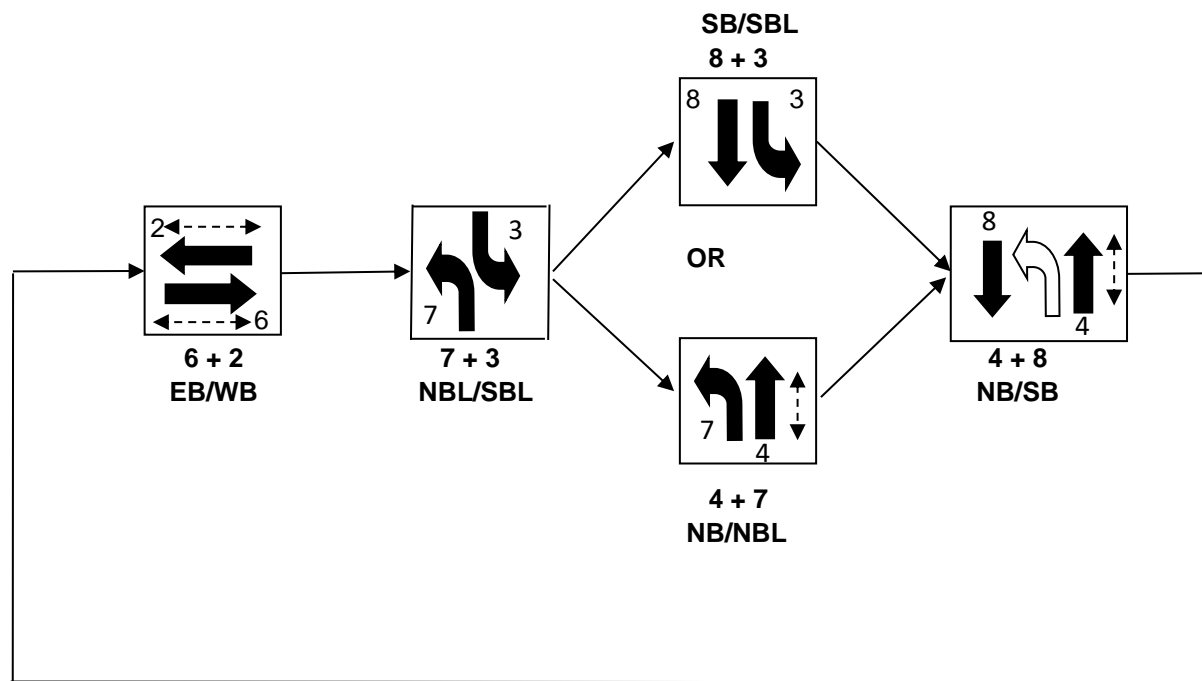

 Denotes permissive left turn

 Denotes pedestrian crosswalk signal

Station : 1177 - Atlantic Blvd & Riverside Dr West (Standard File)

Phase	1	2 (WT)	3 (SL)	4 (NT)	5	6 (ET)	7 (NL)	8 (ST)	9	10	11	12	13	14	15	16
Walk		7		7		7										
Ped Clearance		22		26		22										
Min Green		12	5	6		12	4	6								
Gap Ext		3	1.5	2		3	1.5	2								
Max1		50	18	20		50	30	20								
Max2																
Yellow Clr	4	5	4	4	4	5	4	4	3.5	3.5	3.5	3.5	3.5	3.5	3.5	3.5
Red Clr		2	2	2		2	2	2	1.5	1.5	1.5	1.5	1.5	1.5	1.5	1.5
Red Revert																
Added Initial																
Max Initial																
Time Before Reduce																
Cars Before Reduce																
Time To Reduce																
Reduce By																
Min Gap																
Dynamic Max Limit																
Dynamic Max Step																
Enable		ON	ON	ON		ON	ON	ON								
Auto Flash Entry				ON				ON								
Auto Flash Exit		ON				ON										
Non-Actuated 1																
Non-Actuated 2																
Lock Call																
Min Recall		ON				ON										
Max Recall																
Ped Recall																
Soft Recall																
Dual Entry				ON				ON	ON							
Sim Gap Enable																
Guar Passage																
Rest In Walk		ON				ON										
Cond Service																
Add Init Calc																

Preemption

Channel	1	2	3	4	5	6
Lock Input	ON	ON	ON	ON	ON	ON
Override Auto Flash	ON	ON	ON	ON	ON	ON
Override Higher Preempt	ON	ON	ON	ON	ON	ON
Flash in Dwell						
Link to Preempt						
Delay						
Min Duration						
Min Green						
Min Walk						
Ped Clear						
Track Green						
Min Dwell						
Max Presence						
Track Veh 1						
Track Veh 2						
Track Veh 3						
Track Veh 4						
Dwell Cyc Veh 1						
Dwell Cyc Veh 2						
Dwell Cyc Veh 3						
Dwell Cyc Veh 4						
Dwell Cyc Veh 5						
Dwell Cyc Veh 6						

Preempt LP

Channel	1	2	3	4
Min				
Max				
Enable				
Lock Mode	MAX	MAX	MAX	MAX
Coord in Preempt				
No Skip				
Priority P1				
Priority P2				
Priority P3				
Priority P4				
Lock				
Headway				
Group Lock				
Queue Jump				
Free Mode				
Alt Table				

Station : 1204 - Rock Island Rd & Southgate Blvd (Standard File)

Phase	1 (SL)	2 (NT)	3 (WL)	4 (ET)	5 (NL)	6 (ST)	7 (EL)	8 (WT)	9	10	11	12	13	14	15	16
Walk		7		7		7		7								
Ped Clearance		31		23		31		34								
Min Green	4	12	5	6	4	12	5	6								
Gap Ext	1.5	3	1.5	2	1.5	3	1.5	2								
Max1	15	45	20	30	15	45	20	30								
Max2																
Yellow Clr	4.5	4.5	4.5	4.5	4.5	4.5	4.5	4.5	3.5	3.5	3.5	3.5	3.5	3.5	3.5	3.5
Red Clr	2	2	2	2	2	2	2	2	1.5	1.5	1.5	1.5	1.5	1.5	1.5	1.5
Red Revert																
Added Initial																
Max Initial																
Time Before Reduce																
Cars Before Reduce																
Time To Reduce																
Reduce By																
Min Gap																
Dynamic Max Limit																
Dynamic Max Step																
Enable	ON	ON	ON	ON	ON	ON	ON	ON								
Auto Flash Entry				ON				ON								
Auto Flash Exit		ON				ON										
Non-Actuated 1																
Non-Actuated 2																
Lock Call			ON						ON	ON	ON	ON	ON	ON	ON	ON
Min Recall		ON				ON										
Max Recall																
Ped Recall																
Soft Recall																
Dual Entry				ON				ON								
Sim Gap Enable									ON	ON	ON	ON	ON	ON	ON	ON
Guar Passage																
Rest In Walk		ON				ON										
Cond Service																
Add Init Calc																

Preemption

Channel	1	2	3	4	5	6
Lock Input	ON	ON	ON	ON	ON	ON
Override Auto Flash						
Override Higher Preempt						
Flash in Dwell						
Link to Preempt						
Delay						
Min Duration						
Min Green	6	6	6	6	6	6
Min Walk						
Ped Clear						
Track Green			1		1	
Min Dwell	8	8	8	8	8	8
Max Presence	180	180	180	180	180	180
Track Veh 1			9		9	
Track Veh 2						
Track Veh 3						
Track Veh 4						
Dwell Cyc Veh 1	2	4	1	3	2	4
Dwell Cyc Veh 2	6	8	6	8	5	7
Dwell Cyc Veh 3						
Dwell Cyc Veh 4						
Dwell Cyc Veh 5						
Dwell Cyc Veh 6						

Preempt LP

Channel	1	2	3	4
Min				
Max				
Enable				
Lock Mode	MAX	MAX	MAX	MAX
Coord in Preempt				
No Skip				
Priority P1				
Priority P2				
Priority P3				
Priority P4				
Lock				
Headway				
Group Lock				
Queue Jump				
Free Mode				
Alt Table				

Station : 1221 - Atlantic Blvd & Rock Island Rd (Standard File)

Phase	1 (EL)	2 (WT)	3 (SL)	4 (NT)	5 (WL)	6 (ET)	7 (NL)	8 (ST)	9	10	11	12	13	14	15	16
Walk		7		7		7		7								
Ped Clearance		36		38		36		38								
Min Green	5	12	5	6	5	12	5	6								
Gap Ext	1.5	3	1.5	2	1.5	3	1.5	2								
Max1	20	40	20	35	25	40	20	35								
Max2																
Yellow Clr	4	4	4.5	4.5	4	4	4.5	4.5	3.5	3.5	3.5	3.5	3.5	3.5	3.5	3.5
Red Clr	2	2	2	2	2	2	2	2	1.5	1.5	1.5	1.5	1.5	1.5	1.5	1.5
Red Revert																
Added Initial																
Max Initial																
Time Before Reduce																
Cars Before Reduce																
Time To Reduce																
Reduce By																
Min Gap																
Dynamic Max Limit																
Dynamic Max Step																
Enable	ON	ON	ON	ON	ON	ON	ON	ON								
Auto Flash Entry				ON				ON								
Auto Flash Exit		ON				ON										
Non-Actuated 1																
Non-Actuated 2																
Lock Call	ON		ON		ON		ON		ON	ON	ON	ON	ON	ON	ON	ON
Min Recall		ON				ON										
Max Recall																
Ped Recall																
Soft Recall																
Dual Entry				ON				ON								
Sim Gap Enable									ON	ON	ON	ON	ON	ON	ON	ON
Guar Passage																
Rest In Walk		ON				ON										
Cond Service																
Add Init Calc																

Preemption

Channel	1	2	3	4	5	6
Lock Input	ON	ON	ON	ON	ON	ON
Override Auto Flash						
Override Higher Preempt						
Flash in Dwell						
Link to Preempt						
Delay						
Min Duration						
Min Green	6	6	6	6	6	6
Min Walk						
Ped Clear						
Track Green						
Min Dwell	8	8	8	8	8	8
Max Presence	180	180	180	180	180	180
Track Veh 1						
Track Veh 2						
Track Veh 3						
Track Veh 4						
Dwell Cyc Veh 1	4	2	3	2	4	1
Dwell Cyc Veh 2	8	6	8	5	7	6
Dwell Cyc Veh 3						
Dwell Cyc Veh 4						
Dwell Cyc Veh 5						
Dwell Cyc Veh 6						

Preempt LP

Channel	1	2	3	4
Min				
Max				
Enable				
Lock Mode	MAX	MAX	MAX	MAX
Coord in Preempt				
No Skip				
Priority P1				
Priority P2				
Priority P3				
Priority P4				
Lock				
Headway				
Group Lock				
Queue Jump				
Free Mode				
Alt Table				

Station : 1295 - Atlantic Blvd & NW 76 Ave (Standard File)

Phase	1 (EL)	2 (WT)	3	4 (NT)	5 (WL)	6 (ET)	7	8 (ST)	9	10	11	12	13	14	15	16
Walk		7		7		7		7								
Ped Clearance		15		30		15		30								
Min Green	4	12		6	4	12		6								
Gap Ext	1.5	3		2	1.5	3		2								
Max1	15	50		25	15	50		25								
Max2																
Yellow Clr	4	4	4	4	4	4	4	4	3.5	3.5	3.5	3.5	3.5	3.5	3.5	3.5
Red Clr	2	2		2	2	2		2	1.5	1.5	1.5	1.5	1.5	1.5	1.5	1.5
Red Revert																
Added Initial																
Max Initial																
Time Before Reduce																
Cars Before Reduce																
Time To Reduce																
Reduce By																
Min Gap																
Dynamic Max Limit																
Dynamic Max Step																
Enable	ON	ON		ON	ON	ON		ON								
Auto Flash Entry				ON				ON								
Auto Flash Exit		ON				ON										
Non-Actuated 1																
Non-Actuated 2																
Lock Call									ON	ON	ON	ON	ON	ON	ON	ON
Min Recall		ON						ON								
Max Recall																
Ped Recall																
Soft Recall																
Dual Entry				ON				ON								
Sim Gap Enable				ON				ON	ON	ON	ON	ON	ON	ON	ON	ON
Guar Passage																
Rest In Walk		ON				ON										
Cond Service																
Add Init Calc																

Preemption

Channel	1	2	3	4	5	6
Lock Input	ON	ON	ON	ON	ON	ON
Override Auto Flash						
Override Higher Preempt						
Flash in Dwell						
Link to Preempt						
Delay						
Min Duration						
Min Green	6	6	6	6	6	6
Min Walk						
Ped Clear						
Track Green						
Min Dwell	8	8	8	8	8	8
Max Presence	180	180	180	180	180	180
Track Veh 1						
Track Veh 2						
Track Veh 3						
Track Veh 4						
Dwell Cyc Veh 1	4	2	8	2	4	1
Dwell Cyc Veh 2	8	6		5		6
Dwell Cyc Veh 3						
Dwell Cyc Veh 4						
Dwell Cyc Veh 5						
Dwell Cyc Veh 6						

Preempt LP

Channel	1	2	3	4
Min				
Max				
Enable				
Lock Mode	MAX	MAX	MAX	MAX
Coord in Preempt				
No Skip				
Priority P1				
Priority P2				
Priority P3				
Priority P4				
Lock				
Headway				
Group Lock				
Queue Jump				
Free Mode				
Alt Table				

Station : 1297 - Royal Palm Blvd & Rock Island Rd (Standard File)

Phase	1 (EL)	2 (WT)	3 (SL)	4 (NT)	5 (WL)	6 (ET)	7 (NL)	8 (ST)	9	10	11	12	13	14	15	16
Walk		7		7		7		7								
Ped Clearance		30		30		30		30								
Min Green	5	10	4	6	5	10	4	6								
Gap Ext	1.5	3	1.5	2	1.5	3	1.5	2								
Max1	25	50	20	30	25	50	20	30								
Max2																
Yellow Clr	4.5	4.5	4.5	4.5	4.5	4.5	4.5	4.5	3.5	3.5	3.5	3.5	3.5	3.5	3.5	3.5
Red Clr	2	2	2	2	2	2	2	2	1.5	1.5	1.5	1.5	1.5	1.5	1.5	1.5
Red Revert																
Added Initial																
Max Initial																
Time Before Reduce																
Cars Before Reduce																
Time To Reduce																
Reduce By																
Min Gap																
Dynamic Max Limit																
Dynamic Max Step																
Enable	ON	ON	ON	ON	ON	ON	ON	ON								
Auto Flash Entry				ON				ON								
Auto Flash Exit		ON				ON										
Non-Actuated 1																
Non-Actuated 2																
Lock Call			ON		ON				ON	ON	ON	ON	ON	ON	ON	ON
Min Recall		ON				ON										
Max Recall	ON	ON	ON	ON	ON	ON	ON	ON								
Ped Recall		ON		ON		ON		ON								
Soft Recall																
Dual Entry				ON				ON								
Sim Gap Enable									ON	ON	ON	ON	ON	ON	ON	ON
Guar Passage																
Rest In Walk		ON				ON										
Cond Service																
Add Init Calc																

Preemption

Channel	1	2	3	4	5	6
Lock Input	ON	ON	ON	ON	ON	ON
Override Auto Flash						
Override Higher Preempt						
Flash in Dwell						
Link to Preempt						
Delay						
Min Duration						
Min Green	6	6	6	6	6	6
Min Walk						
Ped Clear						
Track Green			1		1	
Min Dwell	8	8	8	8	8	8
Max Presence	180	180	180	180	180	180
Track Veh 1			9		9	
Track Veh 2						
Track Veh 3						
Track Veh 4						
Dwell Cyc Veh 1	4	2	3	2	4	1
Dwell Cyc Veh 2	8	6	8	5	7	6
Dwell Cyc Veh 3						
Dwell Cyc Veh 4						
Dwell Cyc Veh 5						
Dwell Cyc Veh 6						

Preempt LP

Channel	1	2	3	4
Min				
Max				
Enable				
Lock Mode	MAX	MAX	MAX	MAX
Coord in Preempt				
No Skip				
Priority P1				
Priority P2				
Priority P3				
Priority P4				
Lock				
Headway				
Group Lock				
Queue Jump				
Free Mode				
Alt Table				

Station : 1298 - Rock Island Rd & Margate Blvd (Standard File)

Phase	1 (SL)	2 (NT)	3 (WL)	4 (ET)	5 (NL)	6 (ST)	7 (EL)	8 (WT)	9	10	11	12	13	14	15	16
Walk		7		7		7		7								
Ped Clearance		24		24		24		24								
Min Green	4	12	4	6	4	12	4	6								
Gap Ext	1.5	3	1.5	2	1.5	3	1.5	2								
Max1	12	45	12	25	12	45	12	25								
Max2																
Yellow Clr	4.5	4.5	4	4	4.5	4.5	4	4	3.5	3.5	3.5	3.5	3.5	3.5	3.5	3.5
Red Clr	2	2	2	2	2	2	2	2	1.5	1.5	1.5	1.5	1.5	1.5	1.5	1.5
Red Revert																
Added Initial																
Max Initial																
Time Before Reduce																
Cars Before Reduce																
Time To Reduce																
Reduce By																
Min Gap																
Dynamic Max Limit																
Dynamic Max Step																
Enable	ON	ON	ON	ON	ON	ON	ON	ON								
Auto Flash Entry				ON				ON								
Auto Flash Exit		ON					ON									
Non-Actuated 1																
Non-Actuated 2																
Lock Call							ON		ON	ON	ON	ON	ON	ON	ON	ON
Min Recall		ON					ON									
Max Recall																
Ped Recall																
Soft Recall																
Dual Entry		ON		ON		ON		ON								
Sim Gap Enable	ON	ON		ON	ON	ON		ON	ON	ON	ON	ON	ON	ON	ON	ON
Guar Passage																
Rest In Walk		ON					ON									
Cond Service																
Add Init Calc																

Preemption

Channel	1	2	3	4	5	6
Lock Input	ON	ON	ON	ON	ON	ON
Override Auto Flash						
Override Higher Preempt						
Flash in Dwell						
Link to Preempt						
Delay						
Min Duration						
Min Green	6	6	6	6	6	6
Min Walk						
Ped Clear						
Track Green			1		1	
Min Dwell	8	8	8	8	8	8
Max Presence	180	180	180	180	180	180
Track Veh 1			9		9	
Track Veh 2						
Track Veh 3						
Track Veh 4						
Dwell Cyc Veh 1	2	4	1	3	2	4
Dwell Cyc Veh 2	6	8	6	8	5	7
Dwell Cyc Veh 3						
Dwell Cyc Veh 4						
Dwell Cyc Veh 5						
Dwell Cyc Veh 6						

Preempt LP

Channel	1	2	3	4
Min				
Max				
Enable				
Lock Mode	MAX	MAX	MAX	MAX
Coord in Preempt				
No Skip				
Priority P1				
Priority P2				
Priority P3				
Priority P4				
Lock				
Headway				
Group Lock				
Queue Jump				
Free Mode				
Alt Table				

Station : 1309 - Atlantic Blvd & Ramblewood Dr (Standard File)

Phase	1 (EL)	2 (WT)	3	4 (NT)	5 (WL)	6 (ET)	7	8 (ST)	9	10	11	12	13	14	15	16
Walk		7		7		7		7								
Ped Clearance		31		23		31		23								
Min Green	4	12		6	4	12		6								
Gap Ext	1.5	3		3	1.5	3		3								
Max1	15	40		30	15	40		30								
Max2																
Yellow Clr	5	5	4	4	5	5	4	4	3.5	3.5	3.5	3.5	3.5	3.5	3.5	3.5
Red Clr	2	2	2	2	2	2	2	2	1.5	1.5	1.5	1.5	1.5	1.5	1.5	1.5
Red Revert																
Added Initial																
Max Initial																
Time Before Reduce																
Cars Before Reduce																
Time To Reduce																
Reduce By																
Min Gap																
Dynamic Max Limit																
Dynamic Max Step																
Enable	ON	ON		ON	ON	ON		ON								
Auto Flash Entry				ON				ON								
Auto Flash Exit		ON				ON										
Non-Actuated 1																
Non-Actuated 2																
Lock Call									ON	ON	ON	ON	ON	ON	ON	ON
Min Recall		ON				ON										
Max Recall																
Ped Recall																
Soft Recall																
Dual Entry				ON				ON								
Sim Gap Enable									ON	ON	ON	ON	ON	ON	ON	ON
Guar Passage																
Rest In Walk		ON				ON										
Cond Service																
Add Init Calc																

Preemption

Channel	1	2	3	4	5	6
Lock Input	ON	ON	ON	ON	ON	ON
Override Auto Flash			ON		ON	
Override Higher Preempt			ON		ON	
Flash in Dwell			ON		ON	
Link to Preempt						
Delay						
Min Duration						
Min Green	6	6		6		6
Min Walk						
Ped Clear						
Track Green				1		1
Min Dwell	8	8		8		8
Max Presence	180	180		180		180
Track Veh 1				9		9
Track Veh 2						
Track Veh 3						
Track Veh 4						
Dwell Cyc Veh 1	4	2		2		1
Dwell Cyc Veh 2	8	6		5		6
Dwell Cyc Veh 3						
Dwell Cyc Veh 4						
Dwell Cyc Veh 5						
Dwell Cyc Veh 6						

Preempt LP

Channel	1	2	3	4
Min				
Max				
Enable				
Lock Mode	MAX	MAX	MAX	MAX
Coord in Preempt				
No Skip				
Priority P1				
Priority P2				
Priority P3				
Priority P4				
Lock				
Headway				
Group Lock				
Queue Jump				
Free Mode				
Alt Table				

**Sequence of Operation for (1056) SR 7 (US 441) and Atlantic Blvd (SR 814)
Margate**

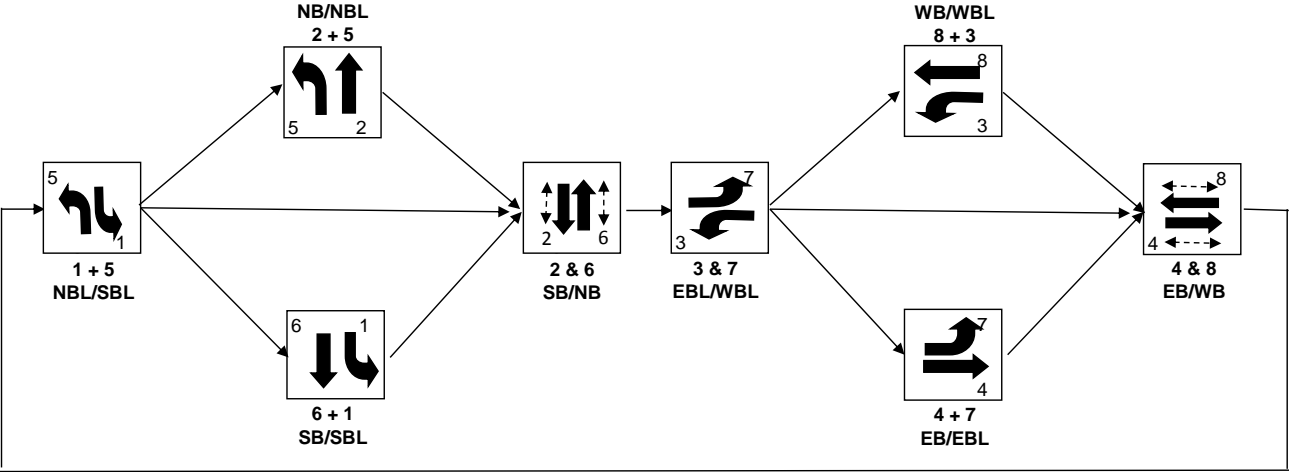

Sequence of Operation for (1159) SR 7 and Margate Boulevard

Margate

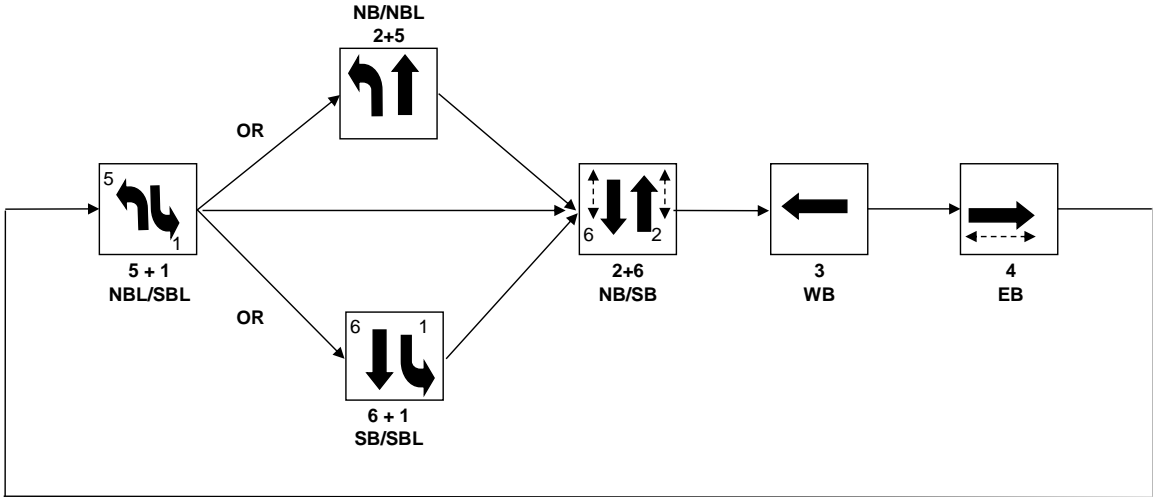

Sequence of Operation for (1204) Rock Island Road and Southgate Boulevard North Lauderdale

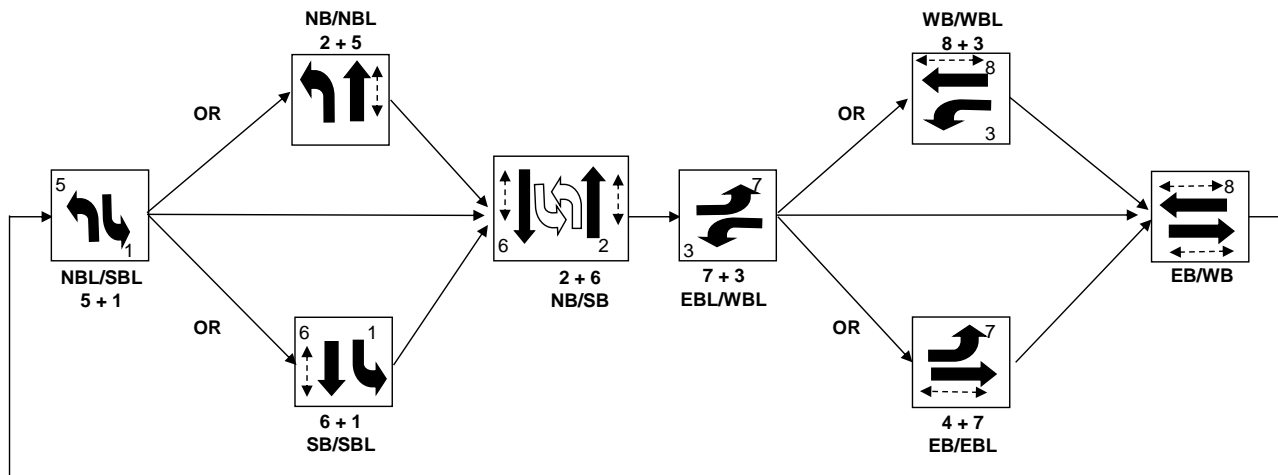

←-----→ Denotes pedestrian signal
 Denotes permissive left turn

Sequence of Operation for (A-221), Atlantic Blvd and Rock Island Rd Margate

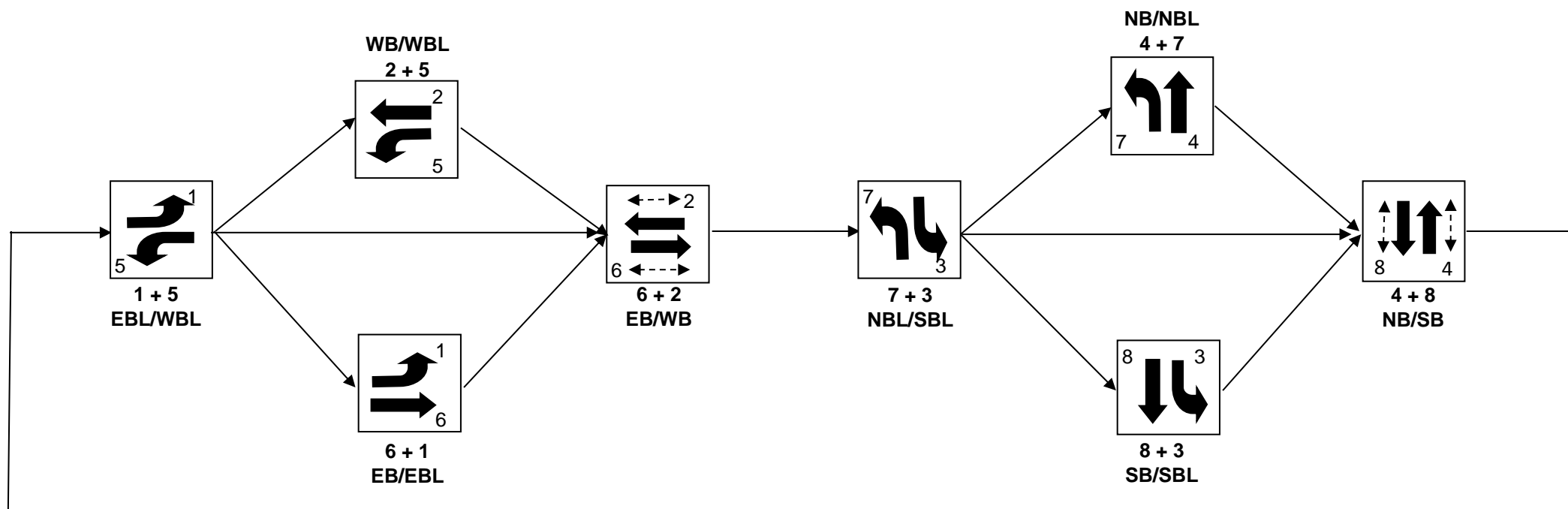

Sequence of Operation for (1295) ATLANTIC BOULEVARD AND NW 76 AVENUE

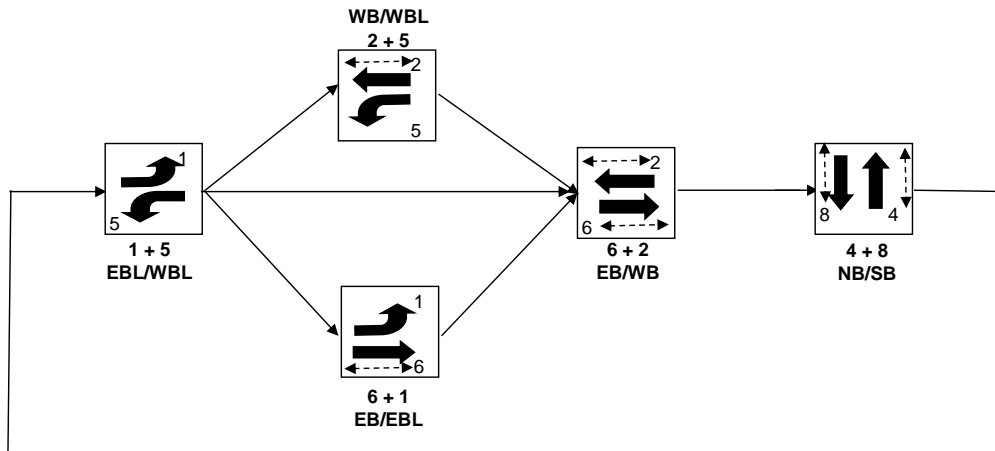

←-----→ Denotes pedestrian crosswalk signal

Sequence of Operation for (1297), ROYAL PALM BOULEVARD AND ROCK ISLAND ROAD

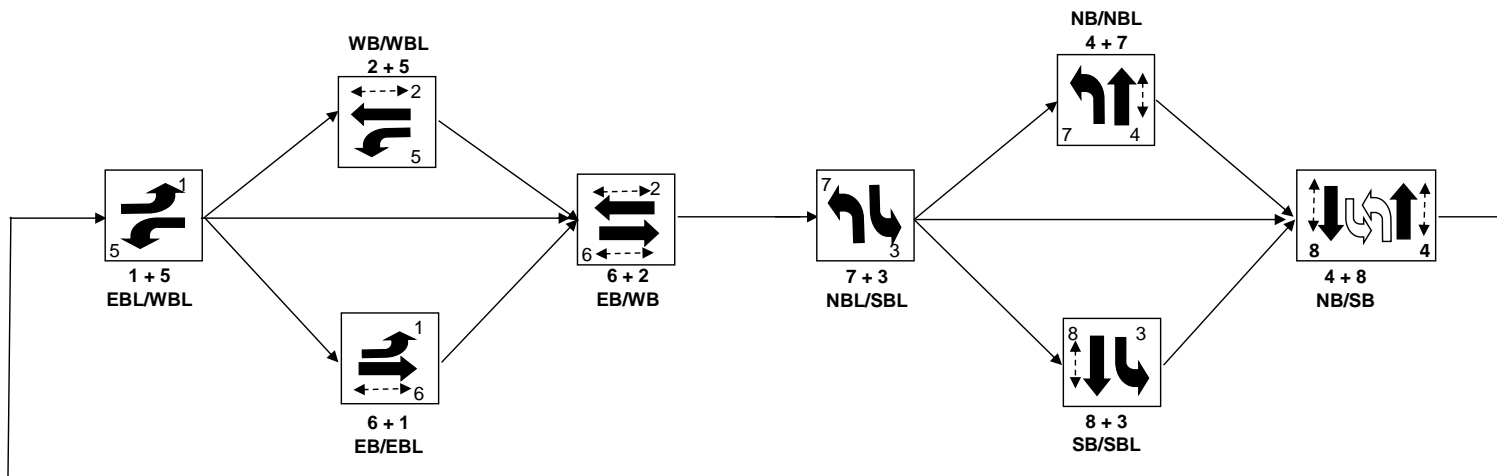

Denotes permissive left turns
 Denotes pedestrian crosswalk signal

Sequence of Operation for (1298) ROCK ISLAND ROAD AND MARGATE BOULEVARD

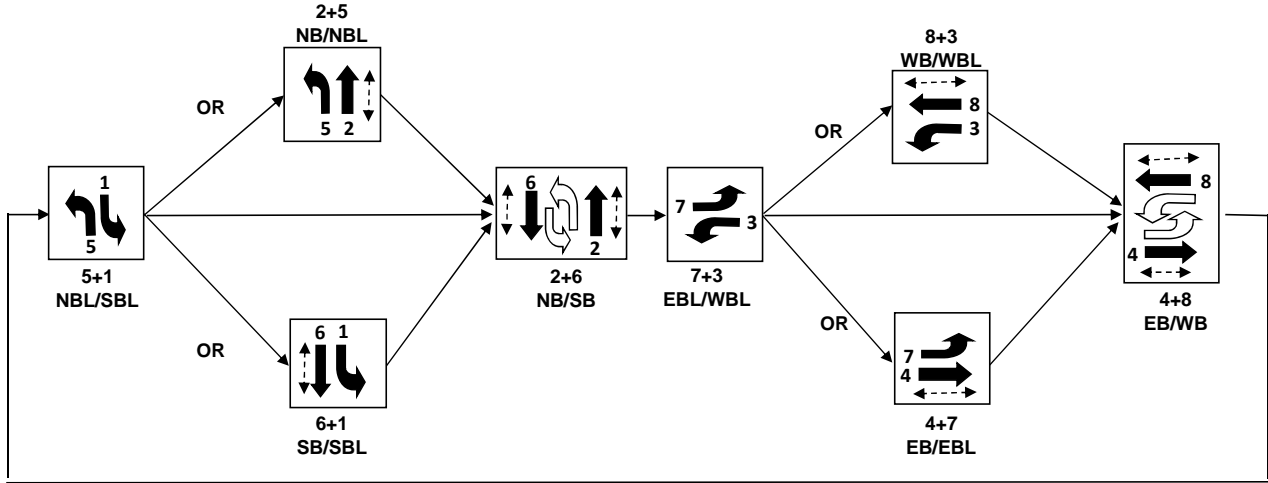

Sequence of Operation for (1309) ATLANTIC BOULEVARD AND RAMBLEWOOD DRIVE

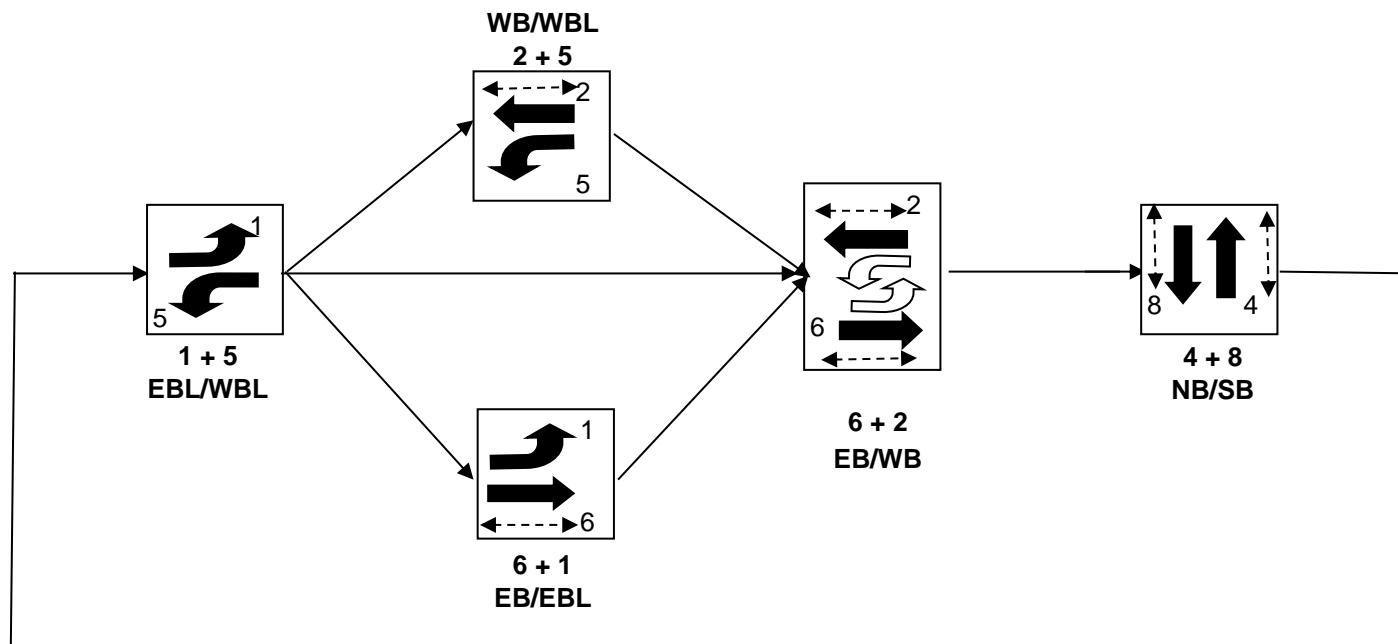

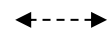
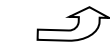
 Denotes pedestrian crosswalk signal
 Denotes permissive left turns

Sequence of Operation for Atlantic Blvd And NW 66 Avenue (1076)

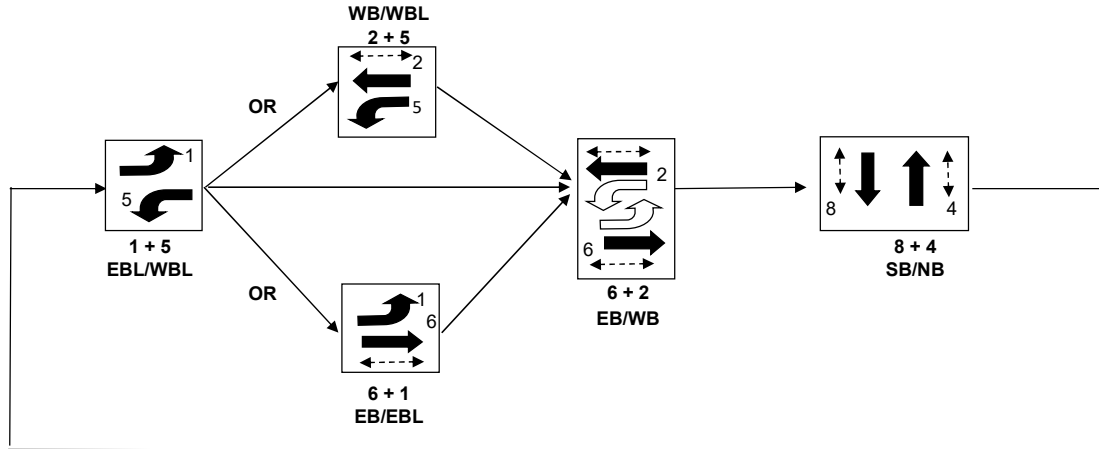

←-----→ Denotes pedestrian crosswalk signal

↪ Denotes permissive left turn



BROWARD COUNTY TRAFFIC ENGINEERING
ACTUATED TRAFFIC SIGNAL TIMING SHEET

Intersection Number	1056	Initial Operation Date	03/23/87
Controller Type	2070 LN	System Number	1056
Modification Number	17	Modification Date	07/08/2014
Drawing/Project No	416878-1-52-01	FPL Grid Number	87288274002
Intersection	SR 7 (US 441) and ATLANTIC BOULEVARD (SR 814)		
Municipality	MARGATE		

Controller Phase	1	2	3	4	5	6	7	8
Face Number	1	2	3	4	5	6	7	8
Direction	SBL	NB	WBL	EB	NBL	SB	EBL	WB
Initial Green(MIN)	5	8	4	6	5	8	4	6
Vehicle Ext.(GAP)	1.5	3.0	1.5	2.5	1.5	3.0	1.5	2.5
Maximum Green I	25	45	20	40	25	45	20	40
Maximum Green II								
Yellow Clearance	5.0	5.0	5.0	5.0	5.0	5.0	5.0	5.0
All Red Clearance	2.0	2.0	2.0	2.0	2.0	2.0	2.0	2.0
Phase Recall	OFF	MIN	OFF	OFF	OFF	MIN	OFF	OFF
Detector Delay								
Walk		7+A		7+A		7+A		7+A
Pedestrian Clearance		36		33		36		30
Permissive	NO		DUAL		NO		DUAL	
Flash Operation	RED	RED	RED	RED	RED	RED	RED	RED

Attachment

NOTES:

1. DUAL ENTRY HARDWIRED EAST/WEST.
2. PHOTO ENFORCEMENT, CITY OF MARGATE.
3. AUDIBLE PEDESTRIAN SIGNALS: E/W BEEP, N/S TONE.
4. MOD. 17 UPDATES YELLOW AND PEDESTRIAN CLEARANCES.

Submitted By _____

Approved By _____



BROWARD COUNTY TRAFFIC ENGINEERING
ACTUATED TRAFFIC SIGNAL TIMING SHEET

Intersection Number	1159	Initial Operation Date	1970
Controller Type	2070 LN	System Number	
Modification Number	15	Modification Date	03/23/2021
Drawing/Project No	DES. GRP. 6	FPL Grid Number	87288358109
Intersection	SR 7 (US 441) and MARGATE BOULEVARD		
Municipality	MARGATE		

Controller Phase	1	2	3	4	5	6	7	8
Face Number	1	2	3,8	4,7	5	6		
Direction	SBL	NB	WB	EB	NBL	SB		
Initial Green(MIN)	4	12	5	7	4	12		
Vehicle Ext.(GAP)	1.5	3.0	2.0	2.0	1.5	3.0		
Maximum Green I	12	50	18	25	15	50		
Maximum Green II								
Yellow Clearance	4.0	4.0	4.0	4.0	4.0	4.0		
All Red Clearance	2.0	2.0	2.5	2.5	2.0	2.0		
Phase Recall	OFF	MIN	OFF	OFF	OFF	MIN		
Detector Delay								
Walk		7		7		7		
Pedestrian Clearance		30		31		26		
Permissive	NO				NO			
Flash Operation	RED	YELLOW	RED	RED	RED	YELLOW		

Attachment

NOTES:

1. MOD. 15 UPDATES PEDESTRIAN CLEARANCES.

Submitted By _____

Approved By _____



BROWARD COUNTY TRAFFIC ENGINEERING
ACTUATED TRAFFIC SIGNAL TIMING SHEET

Intersection Number	1177	Initial Operation Date	06/08/07
Controller Type	2070	System Number	
Modification Number	4	Modification Date	11/10/2014
Drawing/Project No	2005120201	FPL Grid Number	
Intersection	ATLANTIC BOULEVARD and RIVERSIDE DRIVE WEST		
Municipality	CORAL SPRINGS		

Controller Phase	1	2	3	4	5	6	7	8
Face Number		2	3	4		6	7	8
Direction		WB	SBL	NB		EB	NBL	SB
Initial Green(MIN)		12	5	6		12	4	6
Vehicle Ext.(GAP)		3.0	1.5	2.0		3.0	1.5	2.0
Maximum Green I		50	18	20		50	20	20
Maximum Green II								
Yellow Clearance		5.0	4.0	4.0		5.0	4.0	4.0
All Red Clearance		2.0	2.0	2.0		2.0	2.0	2.0
Phase Recall		MIN	OFF	OFF		MIN	OFF	OFF
Detector Delay								
Walk		7		7		7		
Pedestrian Clearance		22		26		22		
Permissive			NO				YES	
Flash Operation		YELLOW	RED	RED		YELLOW		RED

Attachment

NOTES:

1. DUAL ENTRY HARDWIRED NORTH/SOUTH.
2. 60 FEET DETECTION ZONES UTILIZED PHASES 4, 7 AND 8.
3. MOD. 4 UPDATES MAXIMUM GREEN I, YELLOW CLEARANCE, ALL RED CLEARANCE AND PEDESTRIAN TIMING.

Submitted By _____

Approved By _____



BROWARD COUNTY TRAFFIC ENGINEERING
ACTUATED TRAFFIC SIGNAL TIMING SHEET

Intersection Number	1204	Initial Operation Date	12/11/78
Controller Type	2070 LN	System Number	
Modification Number	14	Modification Date	02/11/2019
Drawing/Project No	DES. GRP. 4	FPL Grid Number	87187228602
Intersection	ROCK ISLAND ROAD and SOUTHGATE BOULEVARD		
Municipality	NORTH LAUDERDALE		

Controller Phase	1	2	3	4	5	6	7	8
Face Number	1	2	3	4	5	6	7	8
Direction	SBL	NB	WBL	EB	NBL	SB	EBL	WB
Initial Green(MIN)	4	12	5	6	4	12	5	6
Vehicle Ext.(GAP)	1.5	3.0	1.5	2.0	1.5	3.0	1.5	2.0
Maximum Green I	15	45	20	30	15	45	20	30
Maximum Green II								
Yellow Clearance	4.5	4.5	4.5	4.5	4.5	4.5	4.5	4.5
All Red Clearance	2.0	2.0	2.0	2.0	2.0	2.0	2.0	2.0
Phase Recall	OFF	MIN	OFF	OFF	OFF	MIN	OFF	OFF
Detector Delay								
Walk		7		7		7		7
Pedestrian Clearance		31		23		31		34
Permissive	5 SECT		NO		5 SECT		DUAL	
Flash Operation		YELLOW	RED	RED		YELLOW	RED	RED

Attachment

NOTES:

1. ANTI-BACKDOWN NORTH/SOUTH: PHASES 2+6 ON--->OMIT PHASES 1+5.
2. DUAL ENTRY HARDWIRED EAST/WEST.
3. MOD. 14 UPDATES PHASE 2 & 8 PEDESTRIAN CLEARANCES.

Submitted By _____

Approved By _____



BROWARD COUNTY TRAFFIC ENGINEERING
ACTUATED TRAFFIC SIGNAL TIMING SHEET

Intersection Number	1221	Initial Operation Date	6/23/82
Controller Type	2070	System Number	1221
Modification Number	14	Modification Date	04/04/2019
Drawing/Project No	78421	FPL Grid Number	87188123901
Intersection	ATLANTIC BOULEVARD and ROCK ISLAND ROAD		
Municipality	MARGATE		

Controller Phase	1	2	3	4	5	6	7	8
Face Number	1	2	3	4	5	6	7	8
Direction	EBL	WB	SBL	NB	WBL	EB	NBL	SB
Initial Green(MIN)	5	12	5	6	5	12	5	6
Vehicle Ext.(GAP)	1.5	3.0	1.5	2.0	1.5	3.0	1.5	2.0
Maximum Green I	20	40	20	35	25	40	20	35
Maximum Green II								
Yellow Clearance	4.0	4.0	4.5	4.5	4.0	4.0	4.5	4.5
All Red Clearance	2.0	2.0	2.0	2.0	2.0	2.0	2.0	2.0
Phase Recall	OFF	MIN	OFF	OFF	OFF	MIN	OFF	OFF
Detector Delay								
Walk		7+A		7+A		7+A		7+A
Pedestrian Clearance		36		38		36		38
Permissive	DUAL		DUAL		DUAL		DUAL	
Flash Operation	RED	RED	RED	RED	RED	RED	RED	RED

Attachment

NOTES:

1. DUAL ENTRY HARDWIRED NORTH/SOUTH.
2. AUDIBLE PEDESTRIAN SIGNALS: EAST/WEST BEEP, NORTH/SOUTH TONE.
3. MOD. 14 UPDATES YELLOW CLEARANCE VALUES.

Submitted By _____

Approved By _____



BROWARD COUNTY TRAFFIC ENGINEERING
ACTUATED TRAFFIC SIGNAL TIMING SHEET

Intersection Number	1295	Initial Operation Date	8/24/82
Controller Type	2070 LN	System Number	1295
Modification Number	12	Modification Date	08/05/2019
Drawing/Project No	BOND 004101	FPL Grid Number	87088794000
Intersection	ATLANTIC BOULEVARD and NW 76 AVENUE		
Municipality	MARGATE		

Controller Phase	1	2	3	4	5	6	7	8
Face Number	1	2		4	5	6		8
Direction	EBL	WB		NB	WBL	EB		SB
Initial Green(MIN)	4	12		6	4	12		6
Vehicle Ext.(GAP)	1.5	3.0		2.0	1.5	3.0		2.0
Maximum Green I	15	50		25	15	50		25
Maximum Green II								
Yellow Clearance	4.0	4.0		4.0	4.0	4.0		4.0
All Red Clearance	2.0	2.0		2.0	2.0	2.0		2.0
Phase Recall	OFF	MIN		OFF	OFF	MIN		OFF
Detector Delay								
Walk		7		7		7		7
Pedestrian Clearance		15		30		15		30
Permissive	NO				NO			
Flash Operation	RED	YELLOW		RED	RED	YELLOW		RED

Attachment

NOTES:

1. DUAL ENTRY HARDWIRED NORTH/SOUTH.
2. MOD. 12 UPDATES PHASES 2 & 6 ALL RED CLEARANCE VALUES.

Submitted By _____

Approved By _____



BROWARD COUNTY TRAFFIC ENGINEERING
ACTUATED TRAFFIC SIGNAL TIMING SHEET

Intersection Number	1297	Initial Operation Date	9/15/84
Controller Type	2070 LN	System Number	
Modification Number	20	Modification Date	03/05/2020
Drawing/Project No	GRP 4	FPL Grid Number	87189166701
Intersection	ROYAL PALM BOULEVARD and ROCK ISLAND ROAD		
Municipality	MARGATE		

Controller Phase	1	2	3	4	5	6	7	8
Face Number	1	2	3	4	5	6	7	8
Direction	EBL	WB	SBL	NB	WBL	EB	NBL	SB
Initial Green(MIN)	5	10	4	6	5	10	4	6
Vehicle Ext.(GAP)	1.5	3.0	1.5	2.0	1.5	3.0	1.5	2.0
Maximum Green I	25	50	20	30	25	50	20	30
Maximum Green II								
Yellow Clearance	4.5	4.5	4.5	4.5	4.5	4.5	4.5	4.5
All Red Clearance	2.0	2.0	2.0	2.0	2.0	2.0	2.0	2.0
Phase Recall	OFF	MIN	OFF	OFF	OFF	MIN	OFF	OFF
Detector Delay				20-RT				20-RT
Walk		7		7		7		7
Pedestrian Clearance		30		30		30		30
Permissive	NO		5 SECT		NO		5 SECT	
Flash Operation	RED	YELLOW		RED	RED	YELLOW		RED

Attachment

NOTES:

1. DUAL ENTRY HARDWIRED NORTH/SOUTH.
2. MOD. 20 UPDATES ALL YELLOW CLEARANCE VALUES.

Submitted By _____

Approved By _____



BROWARD COUNTY TRAFFIC ENGINEERING
ACTUATED TRAFFIC SIGNAL TIMING SHEET

Intersection Number	1298	Initial Operation Date	7/11/83
Controller Type	2070 LN	System Number	
Modification Number	9	Modification Date	08/05/2019
Drawing/Project No	GRP 4	FPL Grid Number	87189161407
Intersection	ROCK ISLAND ROAD and MARGATE BOULEVARD		
Municipality	MARGATE		

Controller Phase	1	2	3	4	5	6	7	8
Face Number	1	2	3	4	5	6	7	8
Direction	SBL	NB	WBL	EB	NBL	SB	EBL	WB
Initial Green(MIN)	4	12	4	6	4	12	4	6
Vehicle Ext.(GAP)	1.5	3.0	1.5	2.0	1.5	3.0	1.5	2.0
Maximum Green I	12	45	12	25	12	45	12	25
Maximum Green II								
Yellow Clearance	4.5	4.5	4.0	4.0	4.5	4.5	4.0	4.0
All Red Clearance	2.0	2.0	2.0	2.0	2.0	2.0	2.0	2.0
Phase Recall	OFF	MIN	OFF	OFF	OFF	MIN	OFF	OFF
Detector Delay			5.0				5.0	
Walk		7		7		7		7
Pedestrian Clearance		24		24		24		24
Permissive	5 SECT		5 SECT		5 SECT		5 SECT	
Flash Operation		YELLOW		RED		YELLOW		RED

Attachment

NOTES:

1. FLASH OPERATION: 0000-0600, 7 DAYS.
2. ANTI-BACKDOWN NORTH/SOUTH: PHASES 2+6 ON--->OMIT PHASES 1+5.
3. DUAL ENTRY HARDWIRED EAST/WEST.
4. MOD. 9 UPDATES YELLOW CLEARANCE VALUES.

Submitted By _____

Approved By _____



BROWARD COUNTY TRAFFIC ENGINEERING
ACTUATED TRAFFIC SIGNAL TIMING SHEET

Intersection Number	1309	Initial Operation Date	9/21/83
Controller Type	2070 LN	System Number	1309
Modification Number	7	Modification Date	12/03/2019
Drawing/Project No	DSN.GRP. 2	FPL Grid Number	87088114408
Intersection	ATLANTIC BOULEVARD and RAMBLEWOOD DRIVE		
Municipality	CORAL SPRINGS		

Controller Phase	1	2	3	4	5	6	7	8
Face Number	1	2		4	5	6		8
Direction	EBL	WB		NB	WBL	EB		SB
Initial Green(MIN)	4	12		6	4	12		6
Vehicle Ext.(GAP)	1.5	3.0		3.0	1.5	3.0		3.0
Maximum Green I	15	40		30	15	40		30
Maximum Green II								
Yellow Clearance	5.0	5.0		4.0	5.0	5.0		4.0
All Red Clearance	2.0	2.0		2.0	2.0	2.0		2.0
Phase Recall	OFF	MIN		OFF	OFF	MIN		OFF
Detector Delay				10				
Walk		7		7+E		7		7+E
Pedestrian Clearance		31		23		31		23
Permissive	5 SECT				5 SECT			
Flash Operation		YELLOW		RED		YELLOW		RED

Attachment

NOTES:

- DUAL ENTRY HARDWIRED NORTH/SOUTH
- ANTI-BACKDOWN EAST/WEST: PHASES 2+6 ON-->OMIT PHASES 1+5.
- LEAD PEDESTRIAN INTERVAL (EARLY WALK): 5 SECONDS PHASES 4 AND 8.
- MOD. 7 PROGRAMS LPI PH.4 & 8, AND UPDATES EAST/WEST PEDESTRIAN AND EW/EWL YELLOW CLEARANCE VALUES.

Submitted By _____

Approved By _____



BROWARD COUNTY TRAFFIC ENGINEERING
ACTUATED TRAFFIC SIGNAL TIMING SHEET

Intersection Number	1076	Initial Operation Date	2/14/72
Controller Type	2070 LN	System Number	1076
Modification Number	12	Modification Date	03/17/2020
Drawing/Project No	DES. GRP. 2	FPL Grid Number	87188704009
Intersection	ATLANTIC BOULEVARD and NW 66 AVENUE		
Municipality	MARGATE		

Controller Phase	1	2	3	4	5	6	7	8
Face Number	1	2		4	5	6		8
Direction	EBL	WB		NB	WBL	EB		SB
Initial Green(MIN)	4	10		6	4	10		6
Vehicle Ext.(GAP)	1.5	3.0		2.0	1.5	3.0		2.0
Maximum Green I	12	55		35	12	55		35
Maximum Green II								
Yellow Clearance	4.0	4.0		4.0	4.0	4.0		4.0
All Red Clearance	2.0	2.0		2.0	2.0	2.0		2.0
Phase Recall	OFF	MIN		OFF	OFF	MIN		OFF
Detector Delay								
Walk		7		7+E		7		7+E
Pedestrian Clearance		19		32		19		32
Permissive	5-SECT			5-SECT				
Flash Operation		YELLOW		RED		YELLOW		RED

Attachment

NOTES:

1. ANTI-BACKDOWN EAST/WEST: PHASES 2+6 ON---> OMIT PHASES 1+5.
2. DUAL ENTRY HARDWIRED NORTH/SOUTH.
3. MOD.12 UPDATES PEDESTRIAN CLEARANCE VALUES AND PROGRAMS LEAD-PEDESTRIAN-INTERVAL P4 & P8.

Submitted By _____

Approved By _____

Station : 1076 - Atlantic Blvd & NW 66 Ave (Standard File)

Phase	1 (EL)	2 (WT)	3	4 (NT)	5 (WL)	6 (ET)	7	8 (ST)	9	10	11	12	13	14	15	16
Walk		7		7		7		7								
Ped Clearance		19		32		19		32								
Min Green	4	10		6	4	10		6								
Gap Ext	1.5	3		2	1.5	3		2								
Max1	12	55		35	12	55		35								
Max2																
Yellow Clr	4	4	4	4	4	4	4	4	3.5	3.5	3.5	3.5	3.5	3.5	3.5	3.5
Red Clr	2	2	2	2	2	2	2	2	1.5	1.5	1.5	1.5	1.5	1.5	1.5	1.5
Red Revert																
Added Initial																
Max Initial																
Time Before Reduce																
Cars Before Reduce																
Time To Reduce																
Reduce By																
Min Gap																
Dynamic Max Limit																
Dynamic Max Step																
Enable	ON	ON		ON	ON	ON		ON								
Auto Flash Entry				ON				ON								
Auto Flash Exit		ON				ON										
Non-Actuated 1																
Non-Actuated 2																
Lock Call									ON	ON	ON	ON	ON	ON	ON	ON
Min Recall		ON				ON										
Max Recall																
Ped Recall																
Soft Recall																
Dual Entry				ON				ON								
Sim Gap Enable									ON	ON	ON	ON	ON	ON	ON	ON
Guar Passage																
Rest In Walk		ON				ON										
Cond Service																
Add Init Calc																

Preemption

Channel	1	2	3	4	5	6
Lock Input	ON	ON	ON	ON	ON	ON
Override Auto Flash			ON	ON	ON	
Override Higher Preempt			ON	ON	ON	
Flash in Dwell			ON	ON	ON	
Link to Preempt						
Delay						
Min Duration						
Min Green	6	6				6
Min Walk						
Ped Clear						
Track Green						1
Min Dwell	8	8				8
Max Presence	180	180				180
Track Veh 1						9
Track Veh 2						
Track Veh 3						
Track Veh 4						
Dwell Cyc Veh 1	4	2				1
Dwell Cyc Veh 2	8	6				6
Dwell Cyc Veh 3						
Dwell Cyc Veh 4						
Dwell Cyc Veh 5						
Dwell Cyc Veh 6						

Preempt LP

Channel	1	2	3	4
Min				
Max				
Enable				
Lock Mode	MAX	MAX	MAX	MAX
Coord in Preempt				
No Skip				
Priority P1				
Priority P2				
Priority P3				
Priority P4				
Lock				
Headway				
Group Lock				
Queue Jump				
Free Mode				
Alt Table				

APPENDIX C
PSCF and Historical Data

2019 PEAK SEASON FACTOR CATEGORY REPORT - REPORT TYPE: ALL
 CATEGORY: 8630 WEST-W OF US441

WEEK	DATES	SF	MOCF: 0.97 PSCF
1	01/01/2019 - 01/05/2019	1.01	1.04
2	01/06/2019 - 01/12/2019	1.01	1.04
3	01/13/2019 - 01/19/2019	1.02	1.05
4	01/20/2019 - 01/26/2019	1.00	1.03
5	01/27/2019 - 02/02/2019	0.99	1.02
* 6	02/03/2019 - 02/09/2019	0.98	1.01
* 7	02/10/2019 - 02/16/2019	0.97	1.00
* 8	02/17/2019 - 02/23/2019	0.97	1.00
* 9	02/24/2019 - 03/02/2019	0.97	1.00
*10	03/03/2019 - 03/09/2019	0.97	1.00
*11	03/10/2019 - 03/16/2019	0.97	1.00
*12	03/17/2019 - 03/23/2019	0.97	1.00
*13	03/24/2019 - 03/30/2019	0.97	1.00
*14	03/31/2019 - 04/06/2019	0.97	1.00
*15	04/07/2019 - 04/13/2019	0.97	1.00
*16	04/14/2019 - 04/20/2019	0.97	1.00
*17	04/21/2019 - 04/27/2019	0.97	1.00
*18	04/28/2019 - 05/04/2019	0.98	1.01
19	05/05/2019 - 05/11/2019	0.99	1.02
20	05/12/2019 - 05/18/2019	1.00	1.03
21	05/19/2019 - 05/25/2019	1.01	1.04
22	05/26/2019 - 06/01/2019	1.02	1.05
23	06/02/2019 - 06/08/2019	1.02	1.05
24	06/09/2019 - 06/15/2019	1.03	1.06
25	06/16/2019 - 06/22/2019	1.04	1.07
26	06/23/2019 - 06/29/2019	1.04	1.07
27	06/30/2019 - 07/06/2019	1.05	1.08
28	07/07/2019 - 07/13/2019	1.05	1.08
29	07/14/2019 - 07/20/2019	1.06	1.09
30	07/21/2019 - 07/27/2019	1.05	1.08
31	07/28/2019 - 08/03/2019	1.04	1.07
32	08/04/2019 - 08/10/2019	1.02	1.05
33	08/11/2019 - 08/17/2019	1.01	1.04
34	08/18/2019 - 08/24/2019	1.01	1.04
35	08/25/2019 - 08/31/2019	1.02	1.05
36	09/01/2019 - 09/07/2019	1.02	1.05
37	09/08/2019 - 09/14/2019	1.03	1.06
38	09/15/2019 - 09/21/2019	1.03	1.06
39	09/22/2019 - 09/28/2019	1.02	1.05
40	09/29/2019 - 10/05/2019	1.01	1.04
41	10/06/2019 - 10/12/2019	1.00	1.03
42	10/13/2019 - 10/19/2019	0.98	1.01
43	10/20/2019 - 10/26/2019	0.99	1.02
44	10/27/2019 - 11/02/2019	0.99	1.02
45	11/03/2019 - 11/09/2019	0.99	1.02
46	11/10/2019 - 11/16/2019	0.99	1.02
47	11/17/2019 - 11/23/2019	1.00	1.03
48	11/24/2019 - 11/30/2019	1.00	1.03
49	12/01/2019 - 12/07/2019	1.00	1.03
50	12/08/2019 - 12/14/2019	1.00	1.03
51	12/15/2019 - 12/21/2019	1.01	1.04
52	12/22/2019 - 12/28/2019	1.01	1.04
53	12/29/2019 - 12/31/2019	1.02	1.05

* PEAK SEASON

2022 PEAK SEASON FACTOR CATEGORY REPORT - REPORT TYPE: ALL
 CATEGORY: 8630 WEST-W OF US441

WEEK	DATES	SF	MOCF: 0.97 PSCF
1	01/01/2022 - 01/01/2022	0.99	1.02
2	01/02/2022 - 01/08/2022	1.01	1.04
3	01/09/2022 - 01/15/2022	1.02	1.05
4	01/16/2022 - 01/22/2022	1.01	1.04
5	01/23/2022 - 01/29/2022	1.00	1.03
6	01/30/2022 - 02/05/2022	0.98	1.01
* 7	02/06/2022 - 02/12/2022	0.97	1.00
* 8	02/13/2022 - 02/19/2022	0.96	0.99
* 9	02/20/2022 - 02/26/2022	0.96	0.99
*10	02/27/2022 - 03/05/2022	0.96	0.99
*11	03/06/2022 - 03/12/2022	0.96	0.99
*12	03/13/2022 - 03/19/2022	0.96	0.99
*13	03/20/2022 - 03/26/2022	0.96	0.99
*14	03/27/2022 - 04/02/2022	0.97	1.00
*15	04/03/2022 - 04/09/2022	0.97	1.00
*16	04/10/2022 - 04/16/2022	0.97	1.00
*17	04/17/2022 - 04/23/2022	0.97	1.00
*18	04/24/2022 - 04/30/2022	0.98	1.01
*19	05/01/2022 - 05/07/2022	0.98	1.01
20	05/08/2022 - 05/14/2022	0.99	1.02
21	05/15/2022 - 05/21/2022	1.00	1.03
22	05/22/2022 - 05/28/2022	1.01	1.04
23	05/29/2022 - 06/04/2022	1.02	1.05
24	06/05/2022 - 06/11/2022	1.03	1.06
25	06/12/2022 - 06/18/2022	1.04	1.07
26	06/19/2022 - 06/25/2022	1.04	1.07
27	06/26/2022 - 07/02/2022	1.05	1.08
28	07/03/2022 - 07/09/2022	1.05	1.08
29	07/10/2022 - 07/16/2022	1.06	1.09
30	07/17/2022 - 07/23/2022	1.05	1.08
31	07/24/2022 - 07/30/2022	1.04	1.07
32	07/31/2022 - 08/06/2022	1.03	1.06
33	08/07/2022 - 08/13/2022	1.02	1.05
34	08/14/2022 - 08/20/2022	1.01	1.04
35	08/21/2022 - 08/27/2022	1.02	1.05
36	08/28/2022 - 09/03/2022	1.02	1.05
37	09/04/2022 - 09/10/2022	1.03	1.06
38	09/11/2022 - 09/17/2022	1.03	1.06
39	09/18/2022 - 09/24/2022	1.02	1.05
40	09/25/2022 - 10/01/2022	1.01	1.04
41	10/02/2022 - 10/08/2022	0.99	1.02
42	10/09/2022 - 10/15/2022	0.98	1.01
43	10/16/2022 - 10/22/2022	0.99	1.02
44	10/23/2022 - 10/29/2022	1.00	1.03
45	10/30/2022 - 11/05/2022	1.00	1.03
46	11/06/2022 - 11/12/2022	1.01	1.04
47	11/13/2022 - 11/19/2022	1.02	1.05
48	11/20/2022 - 11/26/2022	1.01	1.04
49	11/27/2022 - 12/03/2022	1.01	1.04
50	12/04/2022 - 12/10/2022	1.00	1.03
51	12/11/2022 - 12/17/2022	0.99	1.02
52	12/18/2022 - 12/24/2022	1.01	1.04
53	12/25/2022 - 12/31/2022	1.02	1.05

* PEAK SEASON

23-FEB-2023 09:11:21

830UPD

4_8630_PKSEASON.TXT

FLORIDA DEPARTMENT OF TRANSPORTATION
 TRANSPORTATION STATISTICS OFFICE
 2020 HISTORICAL AADT REPORT

COUNTY: 86 - BROWARD

SITE: 7593 - ROCK ISLAND RD, S OF ROYAL PALM BLVD

YEAR	AADT		DIRECTION 1		DIRECTION 2	*K FACTOR	D FACTOR	T FACTOR
2020	25000	C	N 12500		S 12500	9.00	55.10	8.80
2019	31500	R	N 16000		S 15500	9.00	56.00	5.50
2018	31500	T	N 16000		S 15500	9.00	56.30	6.00
2017	31500	S	N 16000		S 15500	9.00	57.10	6.20
2016	30500	F	N 15500		S 15000	9.00	56.10	2.90
2015	29500	C	N 15000		S 14500	9.00	56.20	3.40
2014	28500	X				9.00	56.80	7.40
2013	28000	X	0		0	9.00	56.20	7.60
2012	27500	T	0		0	9.00	57.00	5.90
2011	27000	S	0		0	9.00	59.10	6.30
2010	26000	F	N 13000		S 13000	9.60	57.92	9.30
2009	25000	C	N 12500		S 12500	9.71	58.42	5.30
2008	27000	F	N 13500		S 13500	9.67	56.67	6.50
2007	27000	C	N 13500		S 13500	10.19	60.63	4.80
2006	30000	C	N 15000		S 15000	9.61	59.08	2.90
2005	28000	C	N 14000		S 14000	10.00	58.10	0.00

AADT FLAGS: C = COMPUTED; E = MANUAL ESTIMATE; F = FIRST YEAR ESTIMATE
 S = SECOND YEAR ESTIMATE; T = THIRD YEAR ESTIMATE; R = FOURTH YEAR ESTIMATE
 V = FIFTH YEAR ESTIMATE; 6 = SIXTH YEAR ESTIMATE; X = UNKNOWN

*K FACTOR: STARTING WITH YEAR 2011 IS STANDARDK, PRIOR YEARS ARE K30 VALUES

FLORIDA DEPARTMENT OF TRANSPORTATION
TRANSPORTATION STATISTICS OFFICE
2020 HISTORICAL AADT REPORT

COUNTY: 86 - BROWARD

SITE: 7621 - ATLANTIC BLVD, W OF ROCK ISLAND RD

YEAR	AADT		DIRECTION 1		DIRECTION 2	*K FACTOR	D FACTOR	T FACTOR
2020	32500	C	E 17000		W 15500	9.00	55.10	8.80
2019	41500	R	E 20000		W 21500	9.00	56.00	5.50
2018	41500	T	E 20000		W 21500	9.00	56.30	6.00
2017	40500	S	E 19500		W 21000	9.00	57.10	4.90
2016	39500	F	E 19000		W 20500	9.00	56.10	4.90
2015	38500	C	E 18500		W 20000	9.00	56.20	4.90
2014	41000	X				9.00	56.80	7.40
2013	40000	X	0		0	9.00	56.20	7.60
2012	39500	T	0		0	9.00	57.00	5.90
2011	39000	S	0		0	9.00	59.10	6.30
2010	38000	F	E 20000		W 18000	9.60	57.92	9.30
2009	37000	C	E 19500		W 17500	9.71	58.42	5.30
2008	40500	C	E 19500		W 21000	9.67	56.67	6.50
2007	42000	C	E 20000		W 22000	10.19	60.63	4.80
2006	43000	C	E 21500		W 21500	9.61	59.08	2.90
2005	44000	C	E 21500		W 22500	10.00	58.10	0.00

AADT FLAGS: C = COMPUTED; E = MANUAL ESTIMATE; F = FIRST YEAR ESTIMATE
S = SECOND YEAR ESTIMATE; T = THIRD YEAR ESTIMATE; R = FOURTH YEAR ESTIMATE
V = FIFTH YEAR ESTIMATE; 6 = SIXTH YEAR ESTIMATE; X = UNKNOWN

*K FACTOR: STARTING WITH YEAR 2011 IS STANDARDK, PRIOR YEARS ARE K30 VALUES

FLORIDA DEPARTMENT OF TRANSPORTATION
 TRANSPORTATION STATISTICS OFFICE
 2020 HISTORICAL AADT REPORT

COUNTY: 86 - BROWARD

SITE: 9199 - ATLANTIC BLVD., E OF RIVERSIDE DR.

YEAR	AADT		DIRECTION 1		DIRECTION 2	*K FACTOR	D FACTOR	T FACTOR
2020	30500	C	E 16000		W 14500	9.00	55.10	8.80
2019	41500	T	E 21000		W 20500	9.00	56.00	5.50
2018	41500	S	E 21000		W 20500	9.00	56.30	4.90
2017	40500	F	E 20500		W 20000	9.00	57.10	4.90
2016	39500	C	E 20000		W 19500	9.00	56.10	4.90
2015	39000	V	0		0	9.00	56.20	3.40
2014	38000	R				9.00	56.80	7.40
2013	37000	T	0		0	9.00	56.20	7.60
2012	36500	S	0		0	9.00	57.00	5.90
2011	36000	F	0		0	9.00	59.10	6.30
2010	35000	C	E 17500		W 17500	9.60	57.92	9.30
2009	38000	F	E 19000		W 19000	9.71	58.42	5.30
2008	38000	C	E 19000		W 19000	9.67	56.67	6.50
2007	39500	C	E 19500		W 20000	10.19	60.63	4.80
2006	48500	C	E 23000		W 25500	9.61	59.08	2.90
2005	38000	C	E 18500		W 19500	10.00	58.10	0.00

AADT FLAGS: C = COMPUTED; E = MANUAL ESTIMATE; F = FIRST YEAR ESTIMATE
 S = SECOND YEAR ESTIMATE; T = THIRD YEAR ESTIMATE; R = FOURTH YEAR ESTIMATE
 V = FIFTH YEAR ESTIMATE; 6 = SIXTH YEAR ESTIMATE; X = UNKNOWN

*K FACTOR: STARTING WITH YEAR 2011 IS STANDARDK, PRIOR YEARS ARE K30 VALUES

FLORIDA DEPARTMENT OF TRANSPORTATION
 TRANSPORTATION STATISTICS OFFICE
 2020 HISTORICAL AADT REPORT

COUNTY: 86 - BROWARD

SITE: 9200 - MARDGATE BLVD., W OF SR 7

YEAR	AADT		DIRECTION 1		DIRECTION 2	*K FACTOR	D FACTOR	T FACTOR	
2020	5500	C	E	2600	W	2900	9.00	55.10	8.80
2019	8200	R	E	4100	W	4100	9.00	56.00	5.50
2018	8200	T	E	4100	W	4100	9.00	56.30	6.00
2017	8000	S	E	4000	W	4000	9.00	57.10	6.20
2016	7800	F	E	3900	W	3900	9.00	56.10	2.90
2015	7600	C	E	3800	W	3800	9.00	56.20	3.40
2014	8500	T	E	5100	W	3400	9.00	56.80	7.40
2013	8300	S	E	5000	W	3300	9.00	56.20	7.60
2012	8200	F	E	4900	W	3300	9.00	57.00	5.90
2011	8100	C	E	4800	W	3300	9.00	59.10	6.30
2010	8100	F	E	4700	W	3400	9.60	57.92	9.30
2009	7900	C	E	4600	W	3300	9.71	58.42	5.30
2008	6600	C	E	4100	W	2500	9.67	56.67	6.50
2007	8900	C	E	4400	W	4500	10.19	60.63	4.80
2006	10900	C	E	7200	W	3700	9.61	59.08	2.90
2005	9400	C	E	5000	W	4400	10.00	58.10	0.00

AADT FLAGS: C = COMPUTED; E = MANUAL ESTIMATE; F = FIRST YEAR ESTIMATE
 S = SECOND YEAR ESTIMATE; T = THIRD YEAR ESTIMATE; R = FOURTH YEAR ESTIMATE
 V = FIFTH YEAR ESTIMATE; 6 = SIXTH YEAR ESTIMATE; X = UNKNOWN

*K FACTOR: STARTING WITH YEAR 2011 IS STANDARDK, PRIOR YEARS ARE K30 VALUES

FLORIDA DEPARTMENT OF TRANSPORTATION
TRANSPORTATION STATISTICS OFFICE
2020 HISTORICAL AADT REPORT

COUNTY: 86 - BROWARD

SITE: 9343 - RAMBLEWOOD DRIVE, N OF ATLANTIC BLVD.

YEAR	AADT		DIRECTION 1		DIRECTION 2		*K FACTOR	D FACTOR	T FACTOR
2020	4300	C	N	2400	S	1900	9.00	55.10	8.80
2019	8300	R	N	4900	S	3400	9.00	56.00	5.50
2018	8300	T	N	4900	S	3400	9.00	56.30	6.00
2017	8100	S	N	4800	S	3300	9.00	57.10	6.20
2016	7900	F	N	4700	S	3200	9.00	56.10	2.90
2015	7700	C	N	4600	S	3100	9.00	56.20	3.40
2014	6100	X					9.00	56.80	7.40
2013	6000	X		0		0	9.00	56.20	7.60
2012	5900	T		0		0	9.00	57.00	5.90
2011	5800	S		0		0	9.00	59.10	6.30
2010	5700	F		0		0	9.60	57.92	9.30
2009	5600	C	N	0	S	0	9.71	58.42	5.30
2008	5500	C	N	0	S	0	9.67	56.67	6.50
2007	5200	C	N	0	S	0	10.19	60.63	4.80
2006	5700	C	N	0	S	0	9.61	59.08	2.90
2005	5000	C	N		S		10.00	58.10	0.00

AADT FLAGS: C = COMPUTED; E = MANUAL ESTIMATE; F = FIRST YEAR ESTIMATE
S = SECOND YEAR ESTIMATE; T = THIRD YEAR ESTIMATE; R = FOURTH YEAR ESTIMATE
V = FIFTH YEAR ESTIMATE; 6 = SIXTH YEAR ESTIMATE; X = UNKNOWN

*K FACTOR: STARTING WITH YEAR 2011 IS STANDARDK, PRIOR YEARS ARE K30 VALUES

FLORIDA DEPARTMENT OF TRANSPORTATION
TRANSPORTATION STATISTICS OFFICE
2020 HISTORICAL AADT REPORT

COUNTY: 86 - BROWARD

SITE: 9595 - MARGATE BLVD, W OF ROCK ISLAND RD

YEAR	AADT		DIRECTION 1		DIRECTION 2		*K FACTOR	D FACTOR	T FACTOR
2020	3100	C	E	1500	W	1600	9.00	55.10	8.80
2019	4400	T	E	2100	W	2300	9.00	56.00	5.50
2018	4400	S	E	2100	W	2300	9.00	56.30	6.00
2017	4400	F	E	2100	W	2300	9.00	57.10	6.20
2016	4200	C	E	2000	W	2200	9.00	56.10	2.90
2015	5600	V		0		0	9.00	56.20	3.40
2014	5500	R					9.00	56.80	7.40
2013	5400	T		0		0	9.00	56.20	7.60
2012	5300	S		0		0	9.00	57.00	5.90
2011	5200	F		0		0	9.00	59.10	6.30
2010	5000	C	E	2500	W	2500	9.60	57.92	9.30
2009	5000	F	E	2500	W	2500	9.71	58.42	5.30
2008	5000	C	E	2500	W	2500	9.67	56.67	6.50
2007	4600	C	E	2300	W	2300	10.19	60.63	4.80
2006	4900	C	E	2600	W	2300	9.61	59.08	2.90
2005	4800	C	E	2400	W	2400	10.00	58.10	0.00

AADT FLAGS: C = COMPUTED; E = MANUAL ESTIMATE; F = FIRST YEAR ESTIMATE
S = SECOND YEAR ESTIMATE; T = THIRD YEAR ESTIMATE; R = FOURTH YEAR ESTIMATE
V = FIFTH YEAR ESTIMATE; 6 = SIXTH YEAR ESTIMATE; X = UNKNOWN

*K FACTOR: STARTING WITH YEAR 2011 IS STANDARDK, PRIOR YEARS ARE K30 VALUES

APPENDIX D

Growth Rate Analysis

Traffic Trends - V03.a

SR7/US441 -- 0.1 MI S OF COCONUT CREEK PKWY

FIN#	0
Location	1

County:	BROWARD
Station #:	0298
Highway:	SR7/US441

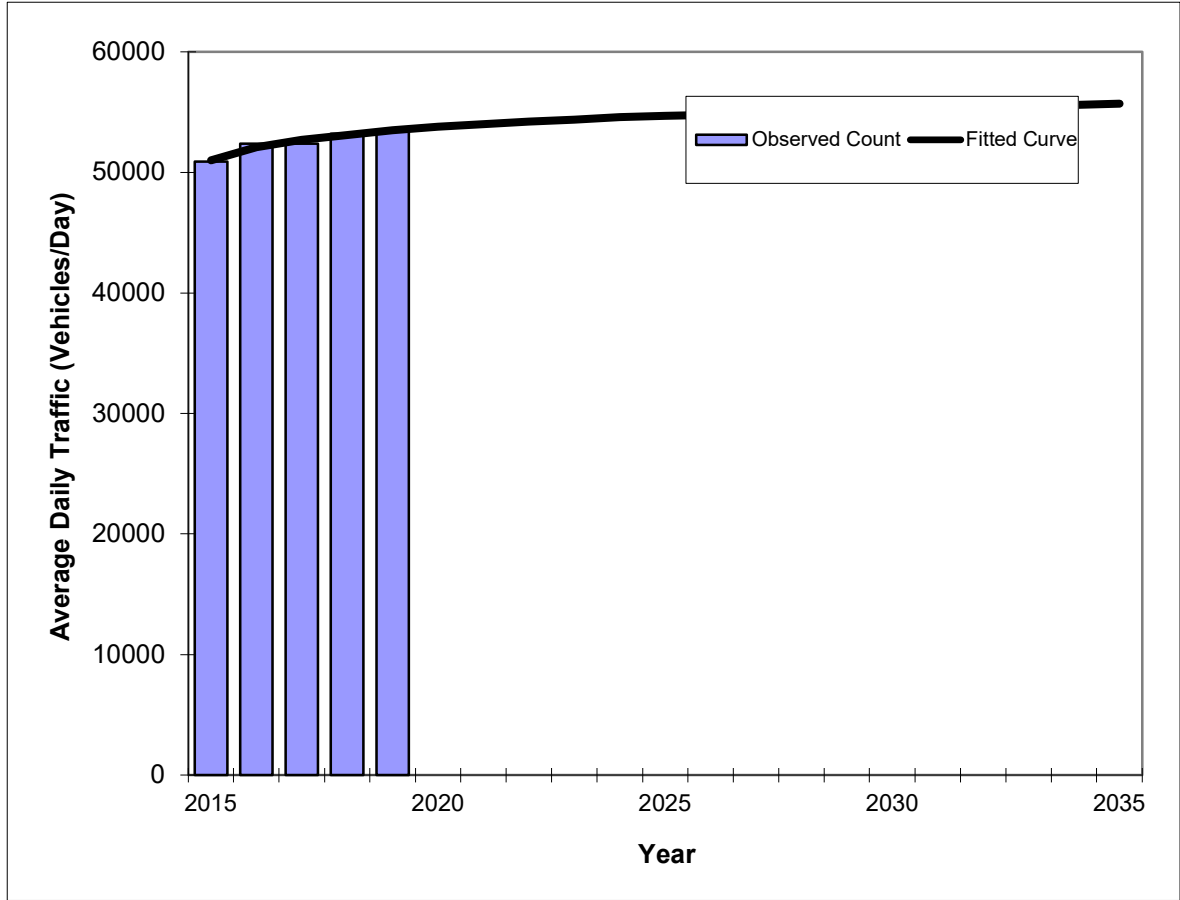

Year	Traffic (ADT/AADT)	
	Count*	Trend**
2015	50900	51000
2016	52400	52100
2017	52400	52700
2018	53200	53100
2019	53500	53500
2022 Opening Year Trend		
2022	N/A	54200
2023 Mid-Year Trend		
2023	N/A	54400
2025 Design Year Trend		
2025	N/A	54700
TRANPLAN Forecasts/Trends		

Trend R-squared:	94.83%
Compounded Annual Historic Growth Rate:	1.20%
Compounded Growth Rate (2019 to Design Year):	0.37%
Printed:	11-May-22
Decaying Exponential Growth Option	

*Axle-Adjusted

Traffic Trends - V03.a

SR7/US441 -- 0.1 MI S OF COCONUT CREEK PKWY

FIN#	0
Location	1

County:	BROWARD
Station #:	0298
Highway:	SR7/US441

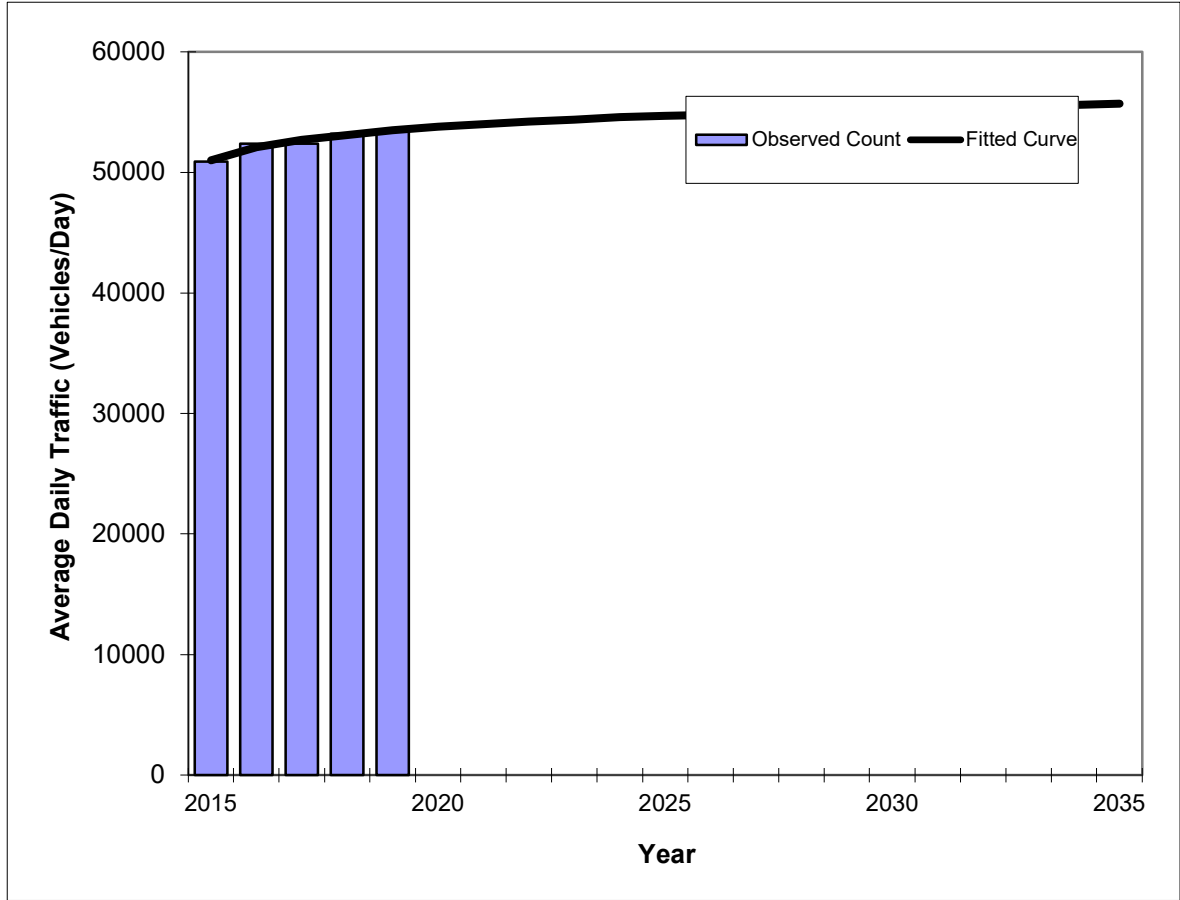

Year	Traffic (ADT/AADT)	
	Count*	Trend**
2015	50900	51000
2016	52400	52100
2017	52400	52700
2018	53200	53100
2019	53500	53500
2022 Opening Year Trend		
2022	N/A	54200
2023 Mid-Year Trend		
2023	N/A	54400
2025 Design Year Trend		
2025	N/A	54700
TRANPLAN Forecasts/Trends		

Trend R-squared:	88.12%
Compounded Annual Historic Growth Rate:	1.20%
Compounded Growth Rate (2019 to Design Year):	0.37%
Printed:	11-May-22
Exponential Growth Option	

*Axle-Adjusted

Traffic Trends - V03.a

SR7/US441 -- 0.1 MI S OF COCONUT CREEK PKWY

FIN#	0
Location	1

County:	BROWARD
Station #:	0298
Highway:	SR7/US441

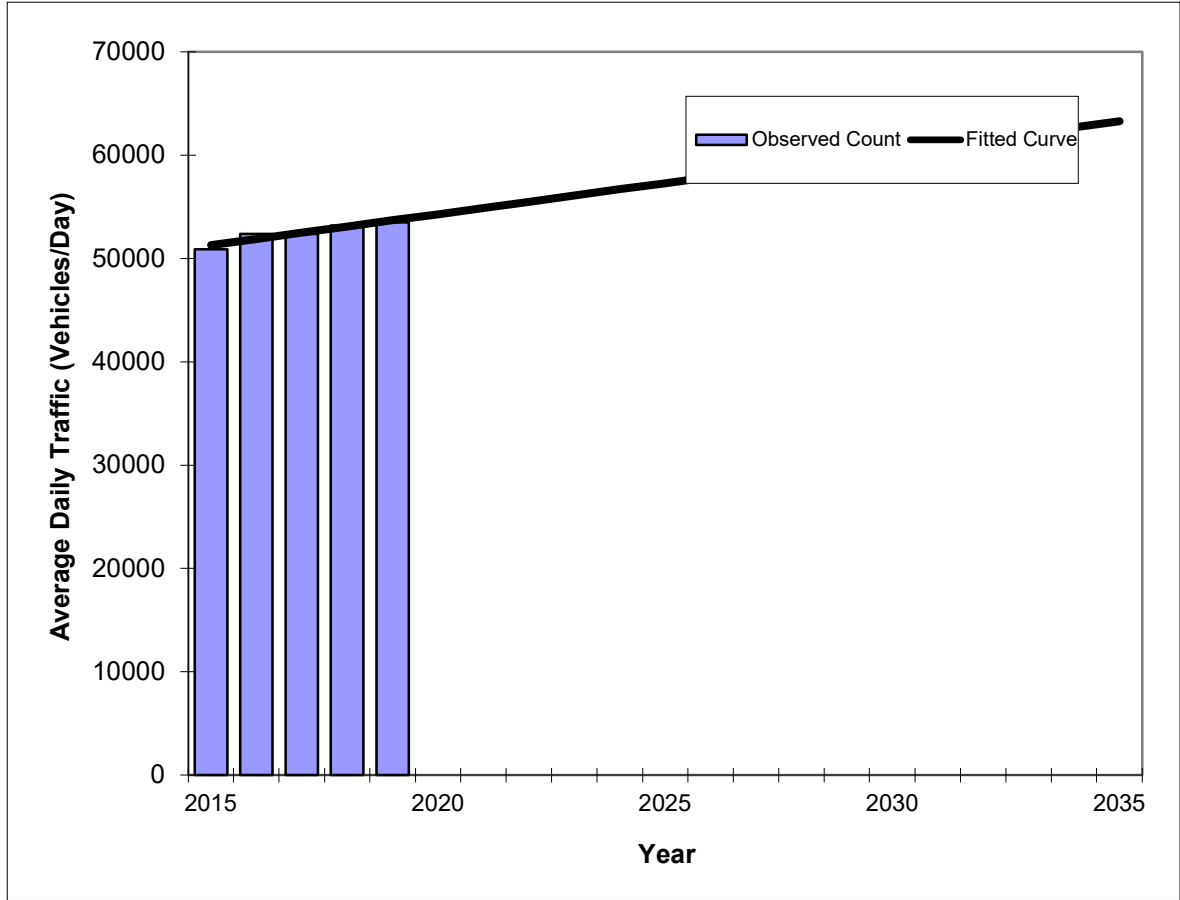

Year	Traffic (ADT/AADT)	
	Count*	Trend**
2015	50900	51300
2016	52400	51900
2017	52400	52500
2018	53200	53100
2019	53500	53700
2022 Opening Year Trend		
2022	N/A	55500
2023 Mid-Year Trend		
2023	N/A	56100
2025 Design Year Trend		
2025	N/A	57300
TRANPLAN Forecasts/Trends		

** Annual Trend Increase:	600
Trend R-squared:	88.50%
Trend Annual Historic Growth Rate:	1.17%
Trend Growth Rate (2019 to Design Year):	1.12%
Printed:	11-May-22

Straight Line Growth Option

*Axle-Adjusted

Traffic Trends - V03.a
CR 814 - ATLANTIC BLVD -- W OF SR 7/US 441

FIN#	0
Location	2

County:	BROWARD
Station #:	5238
Highway:	CR 814 - ATLANTIC BLVD

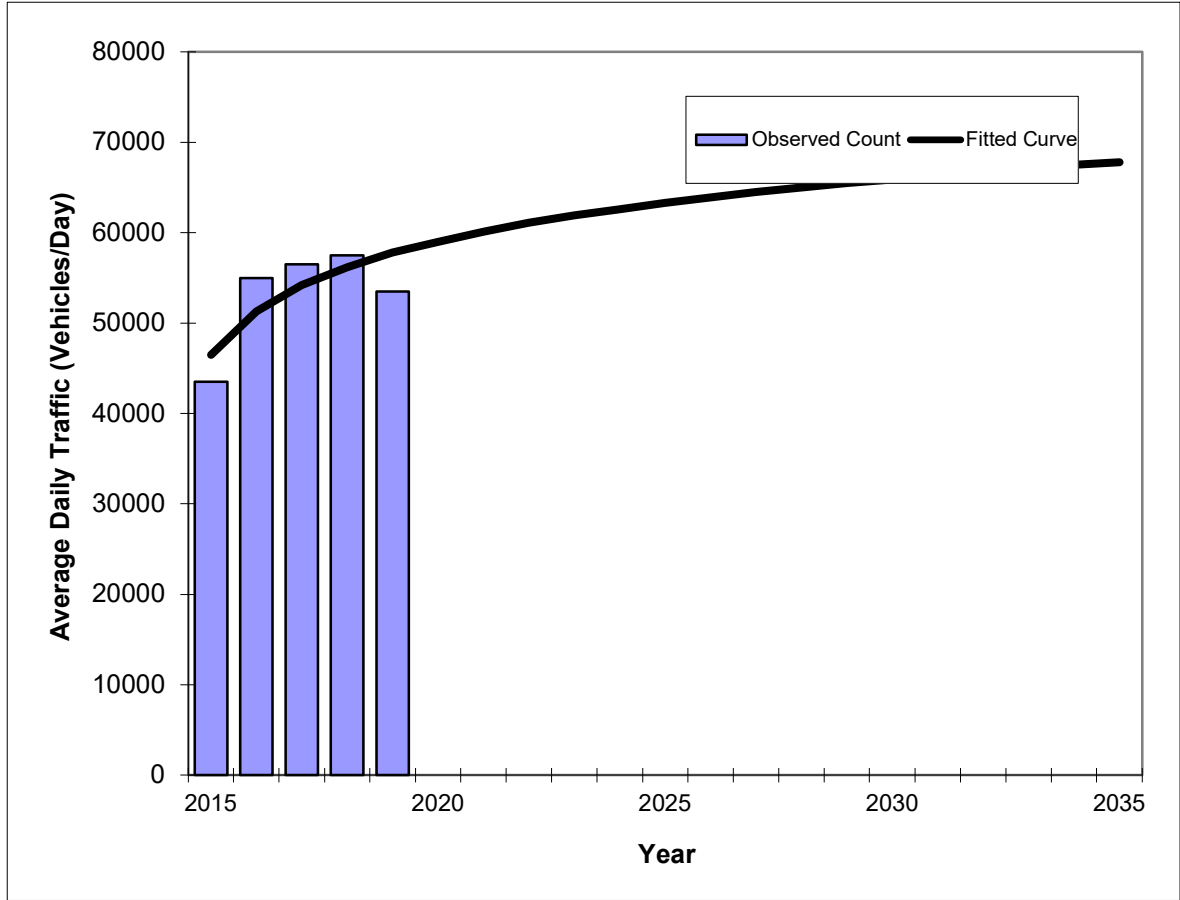

Year	Traffic (ADT/AADT)	
	Count*	Trend**
2015	43500	46500
2016	55000	51300
2017	56500	54200
2018	57500	56200
2019	53500	57800
2022 Opening Year Trend		
2022	N/A	61100
2023 Mid-Year Trend		
2023	N/A	61900
2025 Design Year Trend		
2025	N/A	63300
TRANPLAN Forecasts/Trends		

Trend R-squared:	62.52%
Compounded Annual Historic Growth Rate:	5.59%
Compounded Growth Rate (2019 to Design Year):	1.53%
Printed:	11-May-22
Decaying Exponential Growth Option	

*Axle-Adjusted

Traffic Trends - V03.a

CR 814 - ATLANTIC BLVD -- W OF SR 7/US 441

FIN#	0
Location	2

County:	BROWARD
Station #:	5238
Highway:	CR 814 - ATLANTIC BLVD

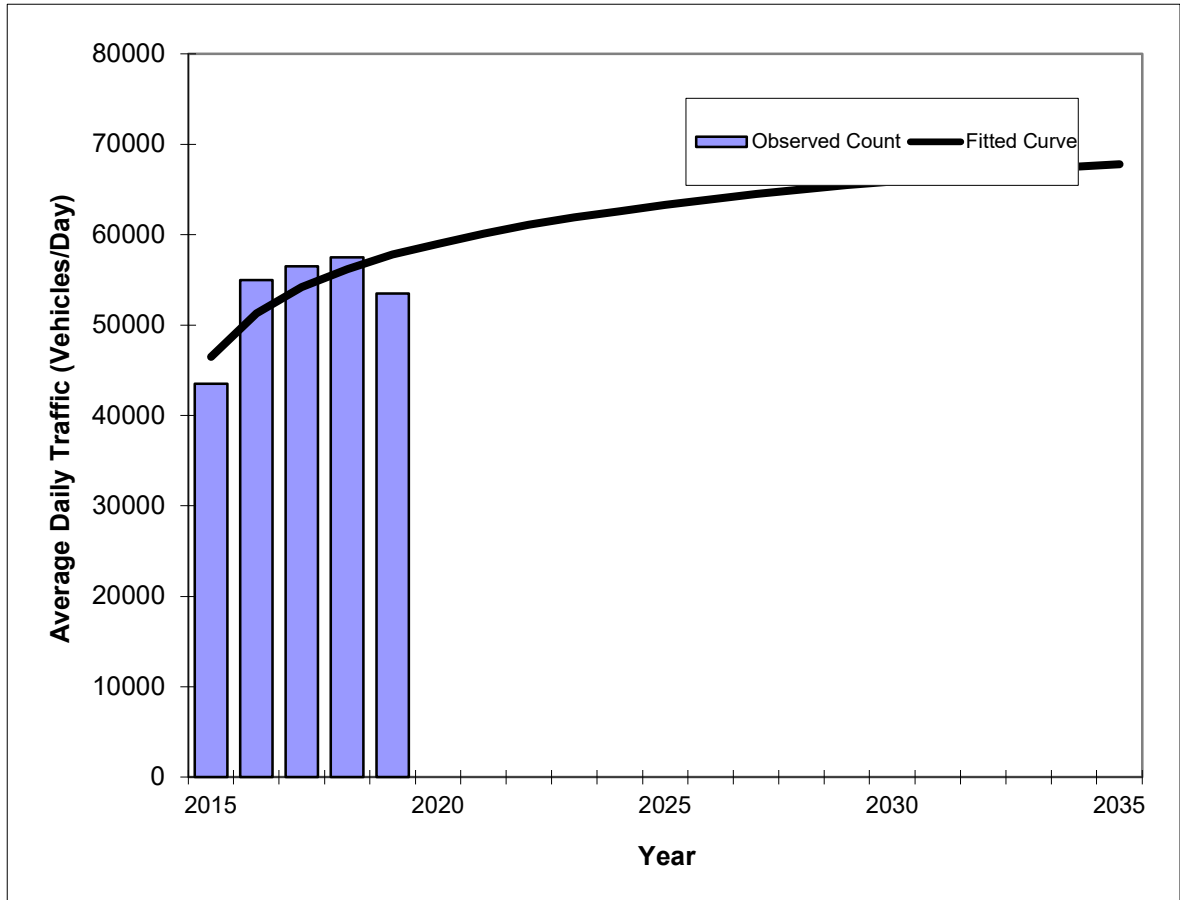

Year	Traffic (ADT/AADT)	
	Count*	Trend**
2015	43500	46500
2016	55000	51300
2017	56500	54200
2018	57500	56200
2019	53500	57800
2022 Opening Year Trend		
2022	N/A	61100
2023 Mid-Year Trend		
2023	N/A	61900
2025 Design Year Trend		
2025	N/A	63300
TRANPLAN Forecasts/Trends		

Trend R-squared:	41.02%
Compounded Annual Historic Growth Rate:	5.59%
Compounded Growth Rate (2019 to Design Year):	1.53%
Printed:	11-May-22
Exponential Growth Option	

*Axle-Adjusted

Traffic Trends - V03.a
CR 814 - ATLANTIC BLVD -- W OF SR 7/US 441

FIN#	0
Location	2

County:	BROWARD
Station #:	5238
Highway:	CR 814 - ATLANTIC BLVD

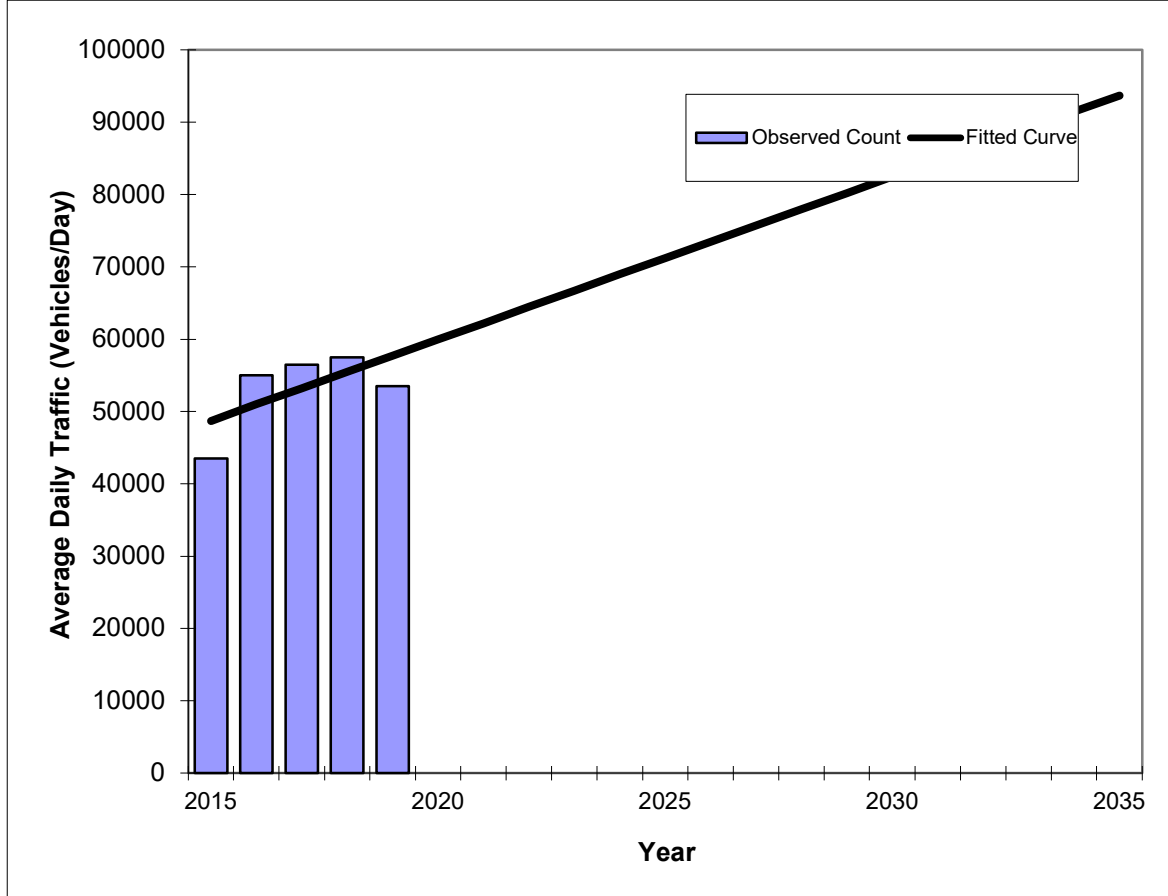

Year	Traffic (ADT/AADT)	
	Count*	Trend**
2015	43500	48700
2016	55000	51000
2017	56500	53200
2018	57500	55500
2019	53500	57700
2022 Opening Year Trend		
2022	N/A	64500
2023 Mid-Year Trend		
2023	N/A	66700
2025 Design Year Trend		
2025	N/A	71200
TRANPLAN Forecasts/Trends		

**** Annual Trend Increase:** 2,250
Trend R-squared: 39.93%
Trend Annual Historic Growth Rate: 4.62%
Trend Growth Rate (2019 to Design Year): 3.90%
Printed: 11-May-22

Straight Line Growth Option

*Axle-Adjusted

Traffic Trends - V03.a

ROYAL PALM BLVD -- E OF RIVERSIDE DR

FIN#	0
Location	3

County:	BROWARD
Station #:	7164
Highway:	ROYAL PALM BLVD

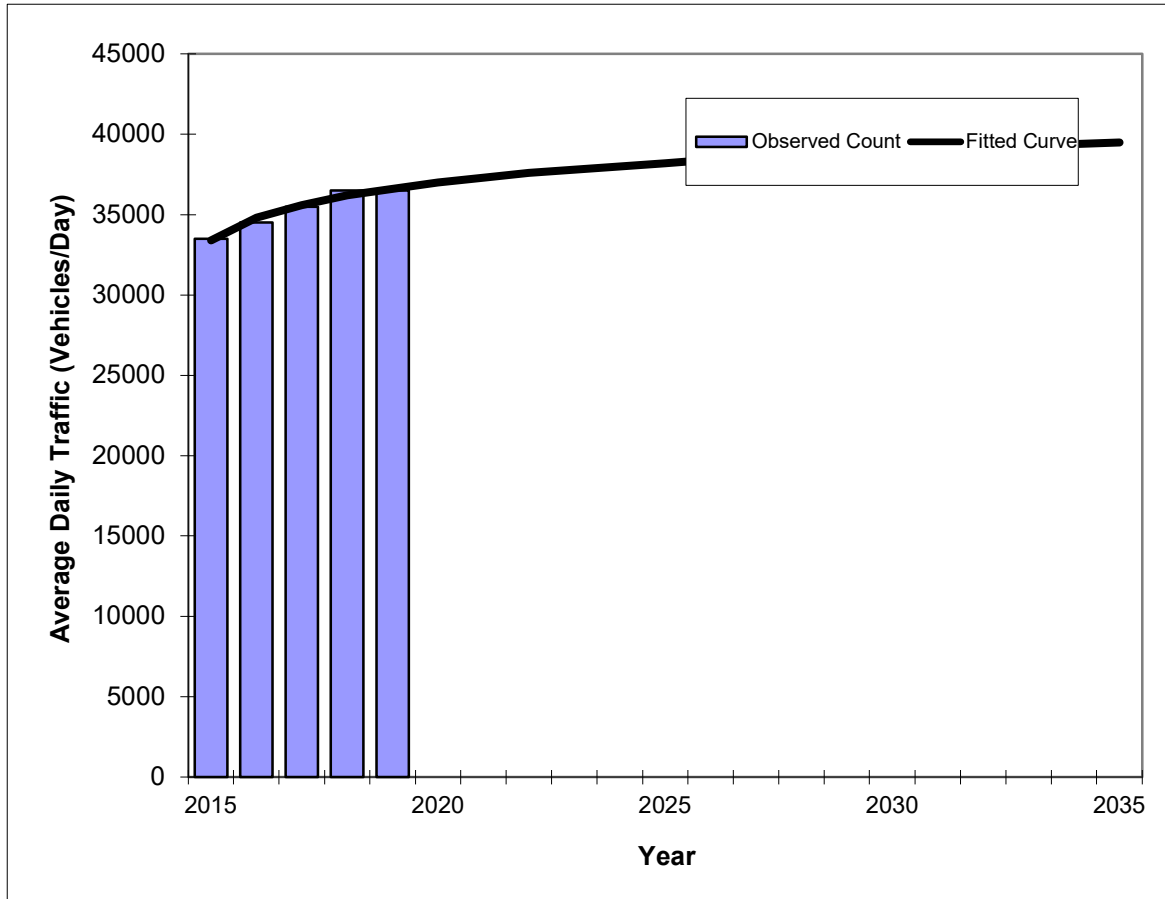

Year	Traffic (ADT/AADT)	
	Count*	Trend**
2015	33500	33400
2016	34500	34800
2017	35500	35600
2018	36500	36200
2019	36500	36600
2022 Opening Year Trend		
2022	N/A	37600
2023 Mid-Year Trend		
2023	N/A	37800
2025 Design Year Trend		
2025	N/A	38200
TRANPLAN Forecasts/Trends		

Trend R-squared:	96.75%
Compounded Annual Historic Growth Rate:	2.31%
Compounded Growth Rate (2019 to Design Year):	0.72%
Printed:	11-May-22
Decaying Exponential Growth Option	

*Axle-Adjusted

Traffic Trends - V03.a

ROYAL PALM BLVD -- E OF RIVERSIDE DR

FIN#	0
Location	3

County:	BROWARD
Station #:	7164
Highway:	ROYAL PALM BLVD

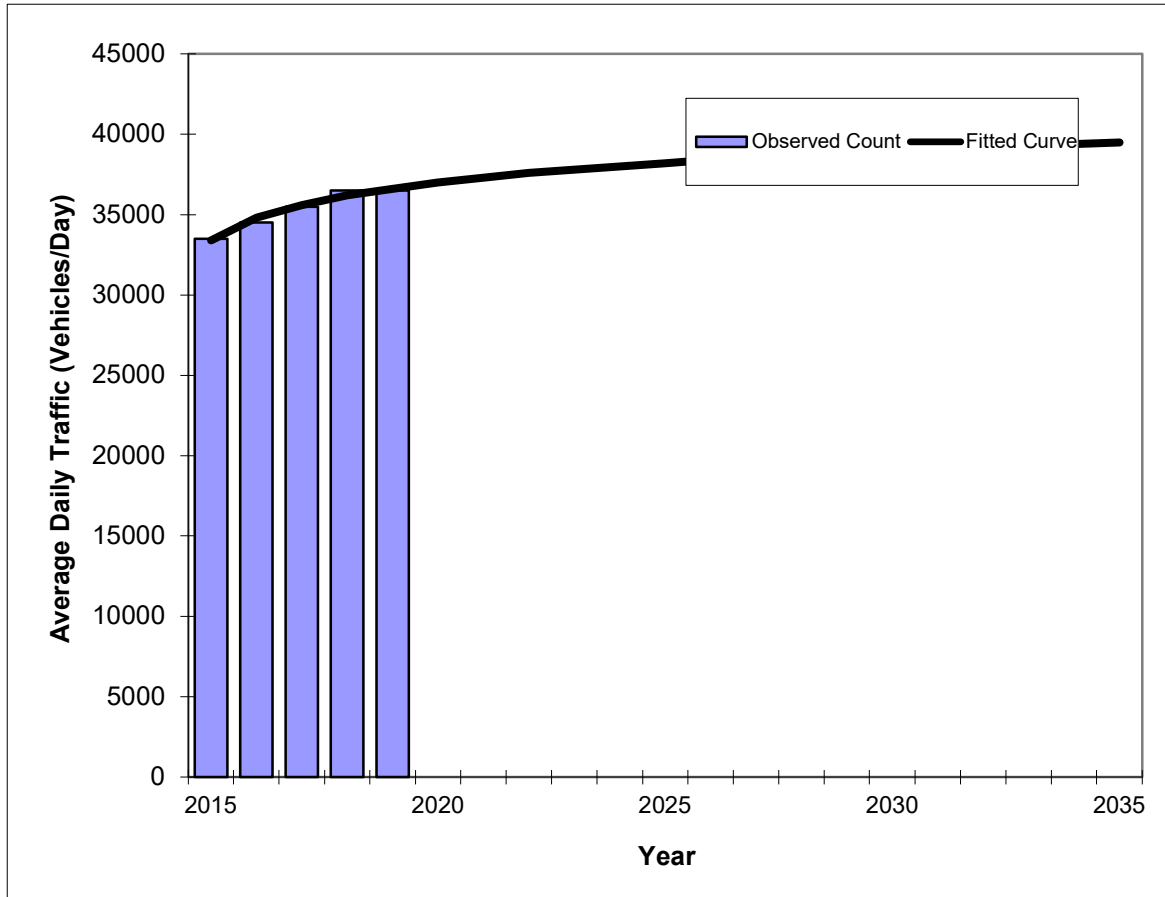

Year	Traffic (ADT/AADT)	
	Count*	Trend**
2015	33500	33400
2016	34500	34800
2017	35500	35600
2018	36500	36200
2019	36500	36600
2022 Opening Year Trend		
2022	N/A	37600
2023 Mid-Year Trend		
2023	N/A	37800
2025 Design Year Trend		
2025	N/A	38200
TRANPLAN Forecasts/Trends		

Trend R-squared:	93.91%
Compounded Annual Historic Growth Rate:	2.31%
Compounded Growth Rate (2019 to Design Year):	0.72%
Printed:	11-May-22
Exponential Growth Option	

*Axle-Adjusted

Traffic Trends - V03.a

ROYAL PALM BLVD -- E OF RIVERSIDE DR

FIN#	0
Location	3

County:	BROWARD
Station #:	7164
Highway:	ROYAL PALM BLVD

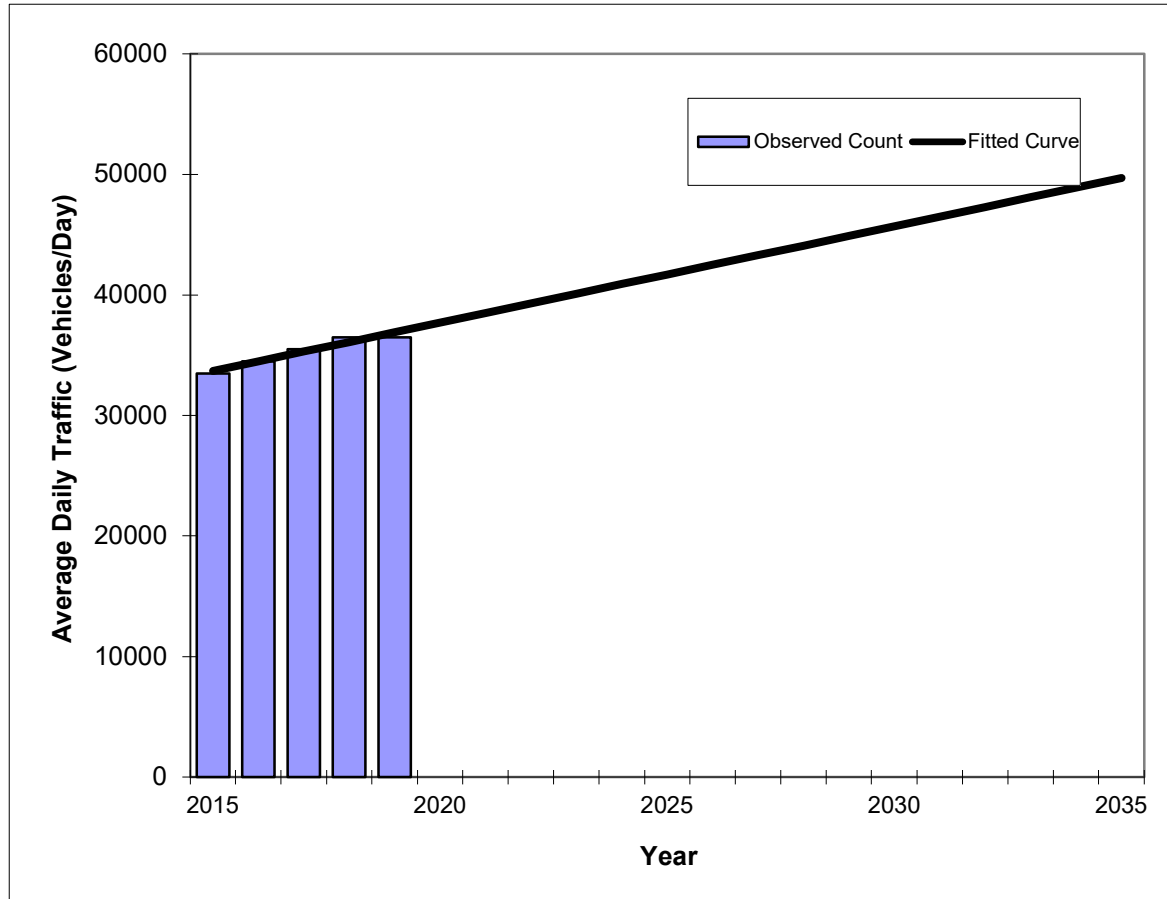

Year	Traffic (ADT/AADT)	
	Count*	Trend**
2015	33500	33700
2016	34500	34500
2017	35500	35300
2018	36500	36100
2019	36500	36900
2022 Opening Year Trend		
2022	N/A	39300
2023 Mid-Year Trend		
2023	N/A	40100
2025 Design Year Trend		
2025	N/A	41700
TRANPLAN Forecasts/Trends		

** Annual Trend Increase:	800
Trend R-squared:	94.12%
Trend Annual Historic Growth Rate:	2.37%
Trend Growth Rate (2019 to Design Year):	2.17%
Printed:	11-May-22
Straight Line Growth Option	

*Axle-Adjusted

Traffic Trends - V03.a ROYAL PALM BLVD -- W OF SR 7

FIN#	0
Location	4

County:	BROWARD
Station #:	7473
Highway:	ROYAL PALM BLVD

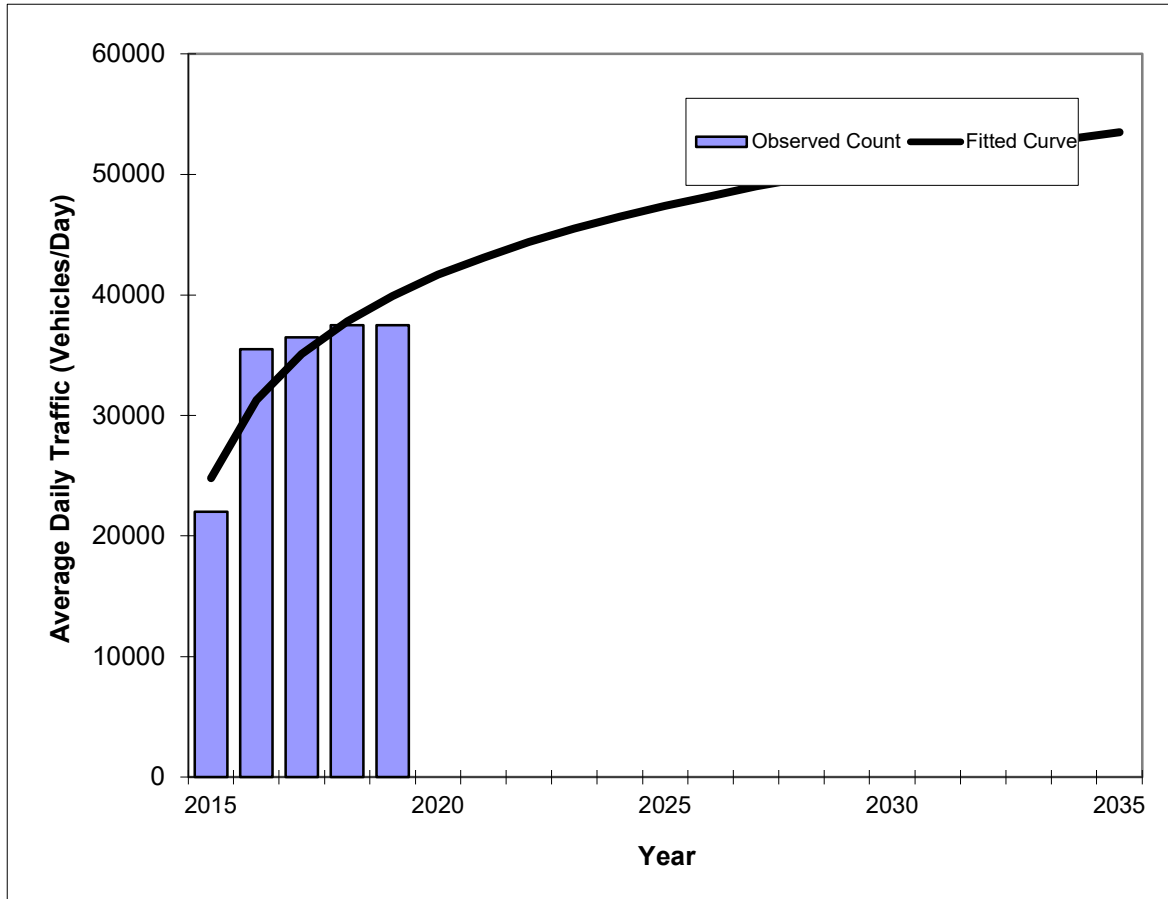

Year	Traffic (ADT/AADT)	
	Count*	Trend**
2015	22000	24800
2016	35500	31300
2017	36500	35100
2018	37500	37800
2019	37500	39900
2022 Opening Year Trend		
2022	N/A	44400
2023 Mid-Year Trend		
2023	N/A	45500
2025 Design Year Trend		
2025	N/A	47400
TRANPLAN Forecasts/Trends		

Trend R-squared:	81.20%
Compounded Annual Historic Growth Rate:	12.62%
Compounded Growth Rate (2019 to Design Year):	2.91%
Printed:	11-May-22
Decaying Exponential Growth Option	

*Axle-Adjusted

Traffic Trends - V03.a

ROYAL PALM BLVD -- W OF SR 7

FIN#	0
Location	4

County:	BROWARD
Station #:	7473
Highway:	ROYAL PALM BLVD

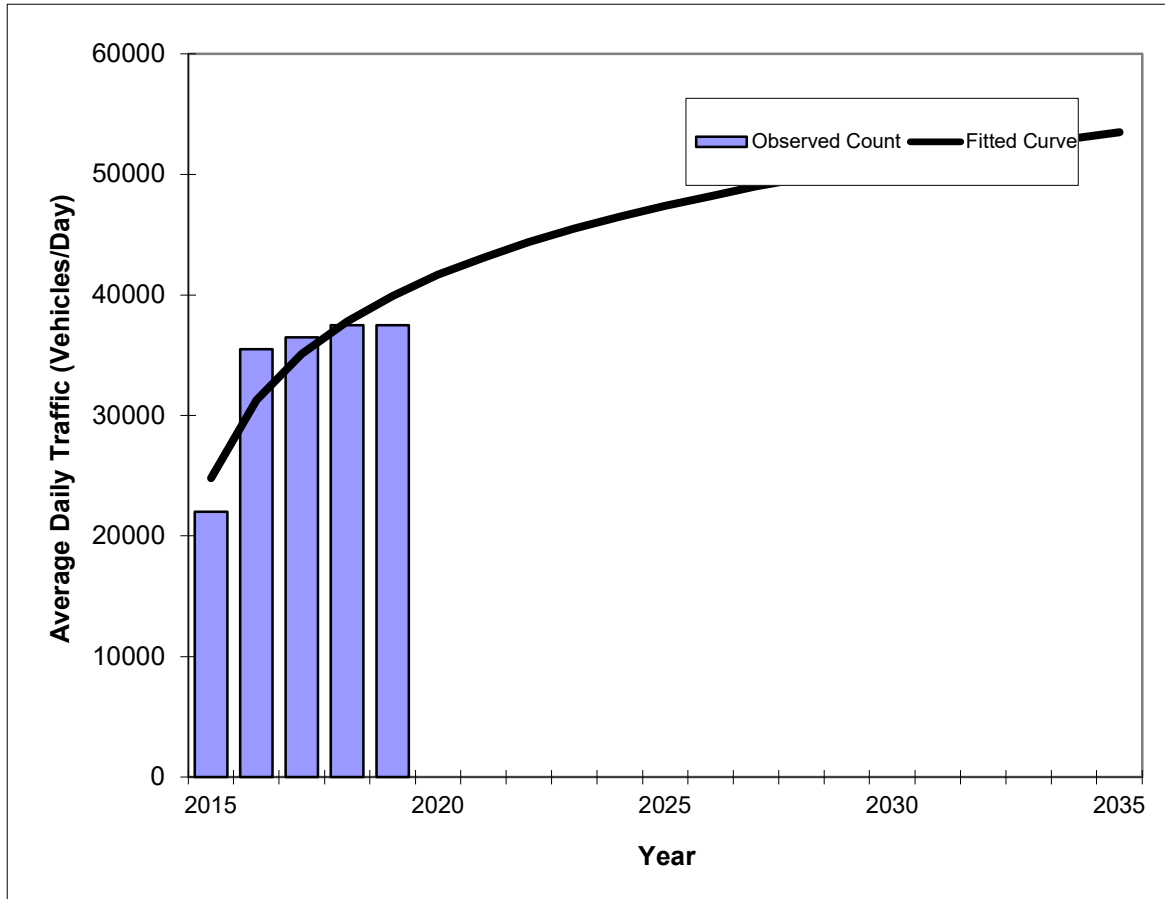

Year	Traffic (ADT/AADT)	
	Count*	Trend**
2015	22000	24800
2016	35500	31300
2017	36500	35100
2018	37500	37800
2019	37500	39900
2022 Opening Year Trend		
2022	N/A	44400
2023 Mid-Year Trend		
2023	N/A	45500
2025 Design Year Trend		
2025	N/A	47400
TRANPLAN Forecasts/Trends		

Trend R-squared:	59.19%
Compounded Annual Historic Growth Rate:	12.62%
Compounded Growth Rate (2019 to Design Year):	2.91%
Printed:	11-May-22
Exponential Growth Option	

*Axle-Adjusted

Traffic Trends - V03.a ROYAL PALM BLVD -- W OF SR 7

FIN#	0
Location	4

County:	BROWARD
Station #:	7473
Highway:	ROYAL PALM BLVD

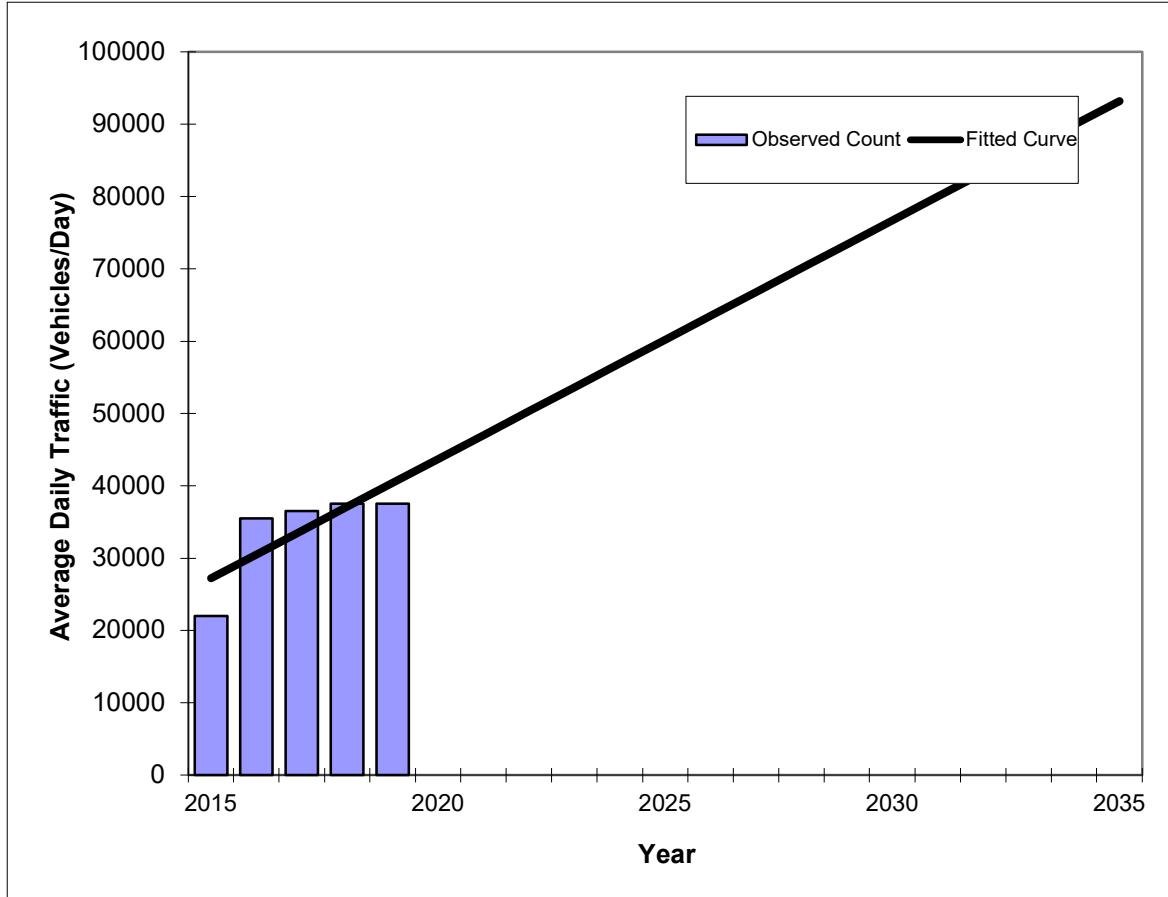

Year	Traffic (ADT/AADT)	
	Count*	Trend**
2015	22000	27200
2016	35500	30500
2017	36500	33800
2018	37500	37100
2019	37500	40400
2022 Opening Year Trend		
2022	N/A	50300
2023 Mid-Year Trend		
2023	N/A	53600
2025 Design Year Trend		
2025	N/A	60200
TRANPLAN Forecasts/Trends		

** Annual Trend Increase:	3,300
Trend R-squared:	61.60%
Trend Annual Historic Growth Rate:	12.13%
Trend Growth Rate (2019 to Design Year):	8.17%
Printed:	11-May-22
Straight Line Growth Option	

*Axle-Adjusted

Traffic Trends - V03.a

RIVERSIDE DR -- S OF ROYAL PALM BLVD

FIN#	0
Location	5

County:	BROWARD
Station #:	7475
Highway:	RIVERSIDE DR

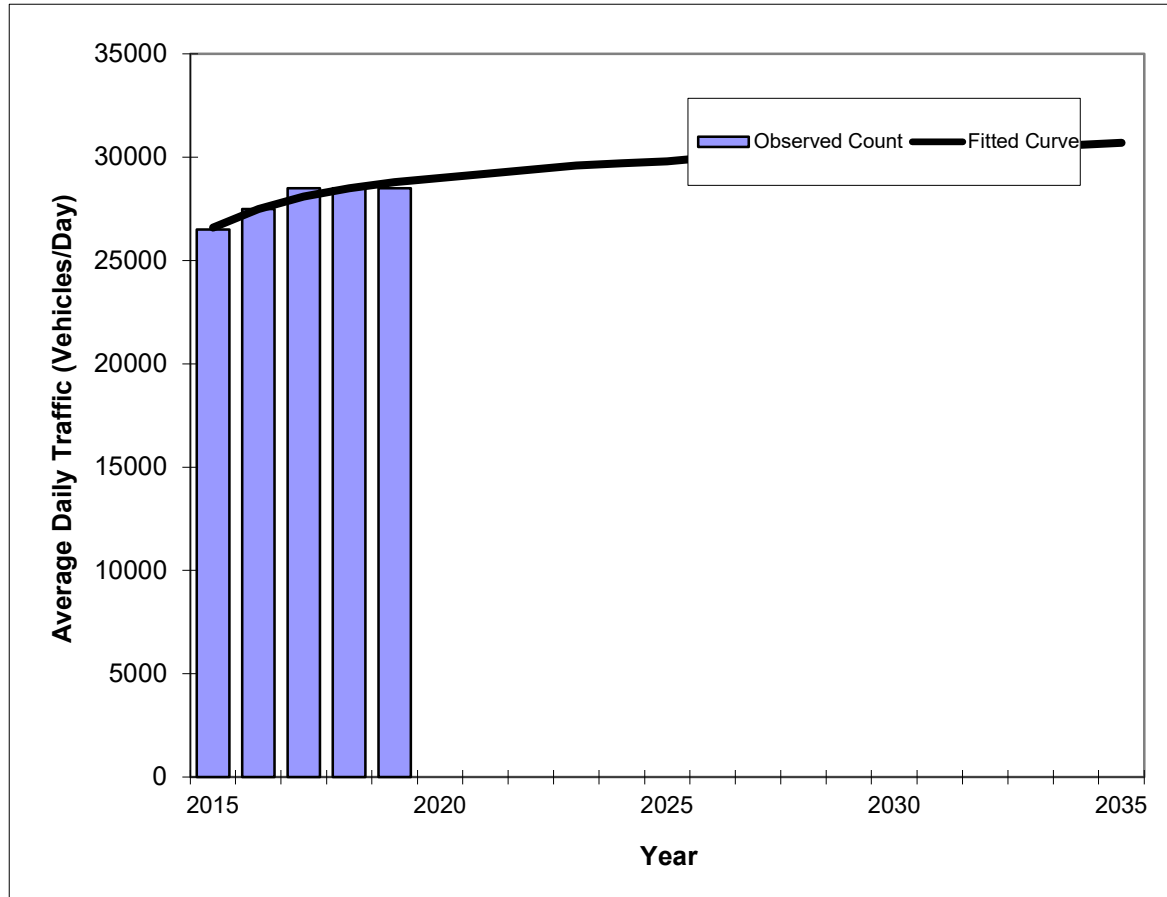

Year	Traffic (ADT/AADT)	
	Count*	Trend**
2015	26500	26600
2016	27500	27500
2017	28500	28100
2018	28500	28500
2019	28500	28800
2022 Opening Year Trend		
2022	N/A	29400
2023 Mid-Year Trend		
2023	N/A	29600
2025 Design Year Trend		
2025	N/A	29800
TRANPLAN Forecasts/Trends		

Trend R-squared:	91.88%
Compounded Annual Historic Growth Rate:	2.01%
Compounded Growth Rate (2019 to Design Year):	0.57%
Printed:	11-May-22
Decaying Exponential Growth Option	

*Axle-Adjusted

Traffic Trends - V03.a
RIVERSIDE DR -- S OF ROYAL PALM BLVD

FIN#	0
Location	5

County:	BROWARD
Station #:	7475
Highway:	RIVERSIDE DR

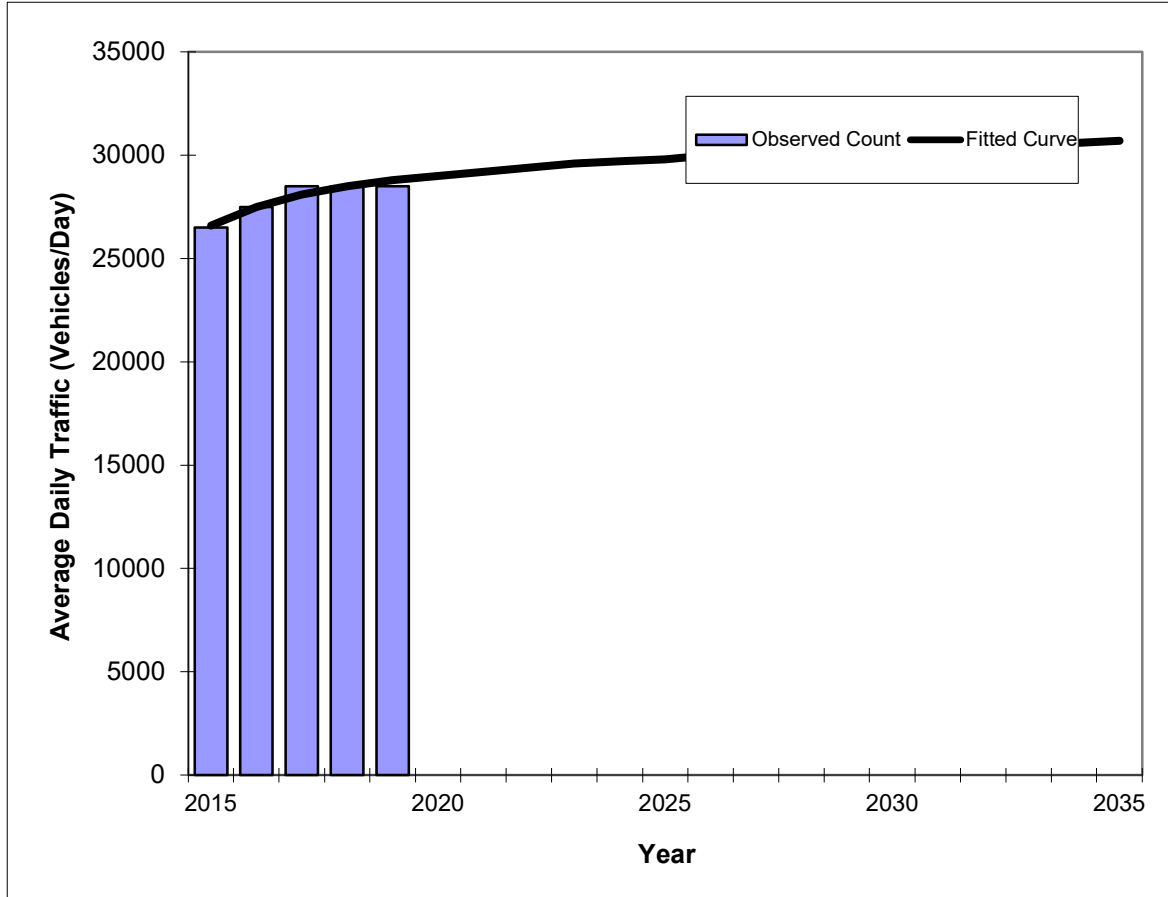

Year	Traffic (ADT/AADT)	
	Count*	Trend**
2015	26500	26600
2016	27500	27500
2017	28500	28100
2018	28500	28500
2019	28500	28800
2022 Opening Year Trend		
2022	N/A	29400
2023 Mid-Year Trend		
2023	N/A	29600
2025 Design Year Trend		
2025	N/A	29800
TRANPLAN Forecasts/Trends		

Trend R-squared:	77.91%
Compounded Annual Historic Growth Rate:	2.01%
Compounded Growth Rate (2019 to Design Year):	0.57%
Printed:	11-May-22
Exponential Growth Option	

*Axle-Adjusted

Traffic Trends - V03.a
RIVERSIDE DR -- S OF ROYAL PALM BLVD

FIN#	0
Location	5

County:	BROWARD
Station #:	7475
Highway:	RIVERSIDE DR

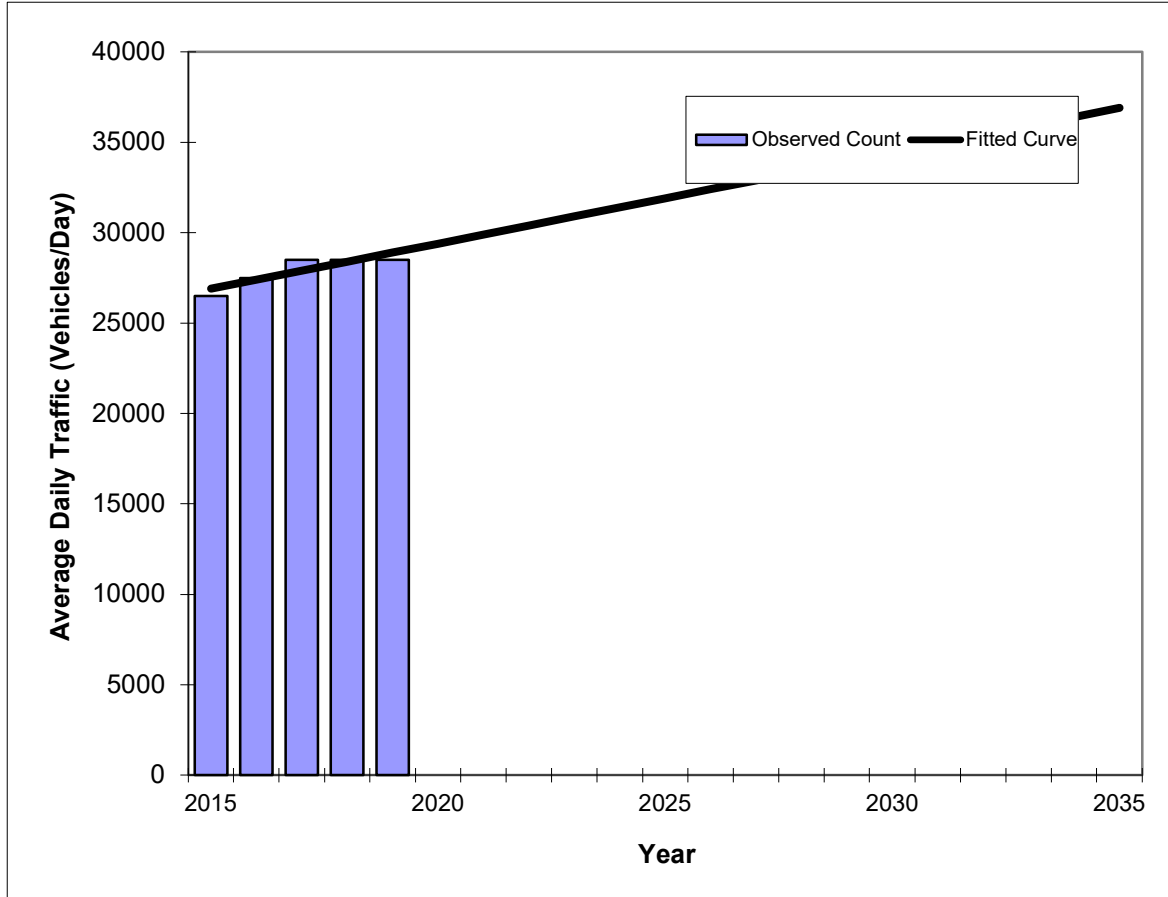

Year	Traffic (ADT/AADT)	
	Count*	Trend**
2015	26500	26900
2016	27500	27400
2017	28500	27900
2018	28500	28400
2019	28500	28900
2022 Opening Year Trend		
2022	N/A	30400
2023 Mid-Year Trend		
2023	N/A	30900
2025 Design Year Trend		
2025	N/A	31900
TRANPLAN Forecasts/Trends		

** Annual Trend Increase:	500
Trend R-squared:	78.13%
Trend Annual Historic Growth Rate:	1.86%
Trend Growth Rate (2019 to Design Year):	1.73%
Printed:	11-May-22
Straight Line Growth Option	

*Axle-Adjusted

Traffic Trends - V03.a

RIVERSIDE DR -- N OF ATLANTIC BLVD

FIN#	0
Location	6

County:	BROWARD
Station #:	7507
Highway:	RIVERSIDE DR

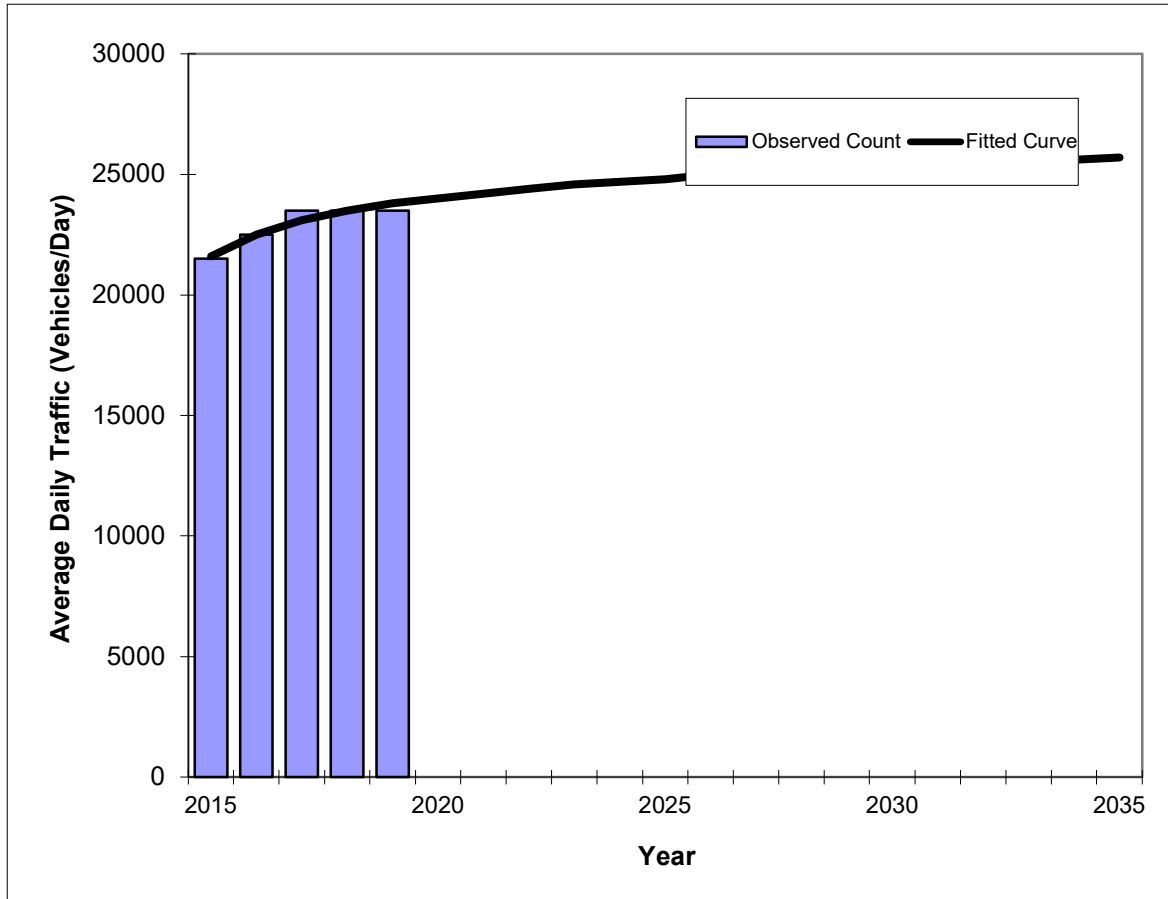

Year	Traffic (ADT/AADT)	
	Count*	Trend**
2015	21500	21600
2016	22500	22500
2017	23500	23100
2018	23500	23500
2019	23500	23800
2022 Opening Year Trend		
2022	N/A	24400
2023 Mid-Year Trend		
2023	N/A	24600
2025 Design Year Trend		
2025	N/A	24800
TRANPLAN Forecasts/Trends		

Trend R-squared:	91.88%
Compounded Annual Historic Growth Rate:	2.45%
Compounded Growth Rate (2019 to Design Year):	0.69%
Printed:	11-May-22
Decaying Exponential Growth Option	

*Axle-Adjusted

Traffic Trends - V03.a

RIVERSIDE DR -- N OF ATLANTIC BLVD

FIN#	0
Location	6

County:	BROWARD
Station #:	7507
Highway:	RIVERSIDE DR

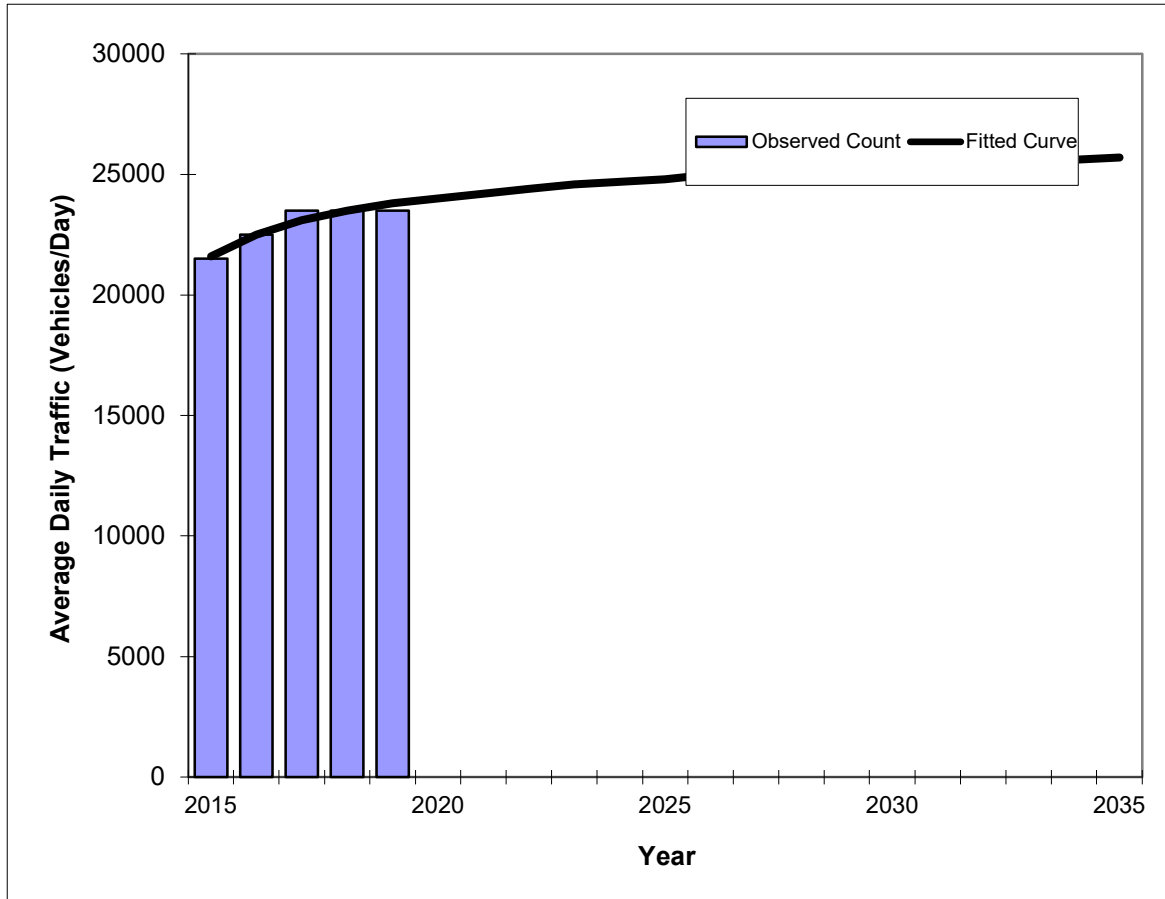

Year	Traffic (ADT/AADT)	
	Count*	Trend**
2015	21500	21600
2016	22500	22500
2017	23500	23100
2018	23500	23500
2019	23500	23800
2022 Opening Year Trend		
2022	N/A	24400
2023 Mid-Year Trend		
2023	N/A	24600
2025 Design Year Trend		
2025	N/A	24800
TRANPLAN Forecasts/Trends		

Trend R-squared:	77.85%
Compounded Annual Historic Growth Rate:	2.45%
Compounded Growth Rate (2019 to Design Year):	0.69%
Printed:	11-May-22
Exponential Growth Option	

*Axle-Adjusted

Traffic Trends - V03.a
RIVERSIDE DR -- N OF ATLANTIC BLVD

FIN#	0
Location	6

County:	BROWARD
Station #:	7507
Highway:	RIVERSIDE DR

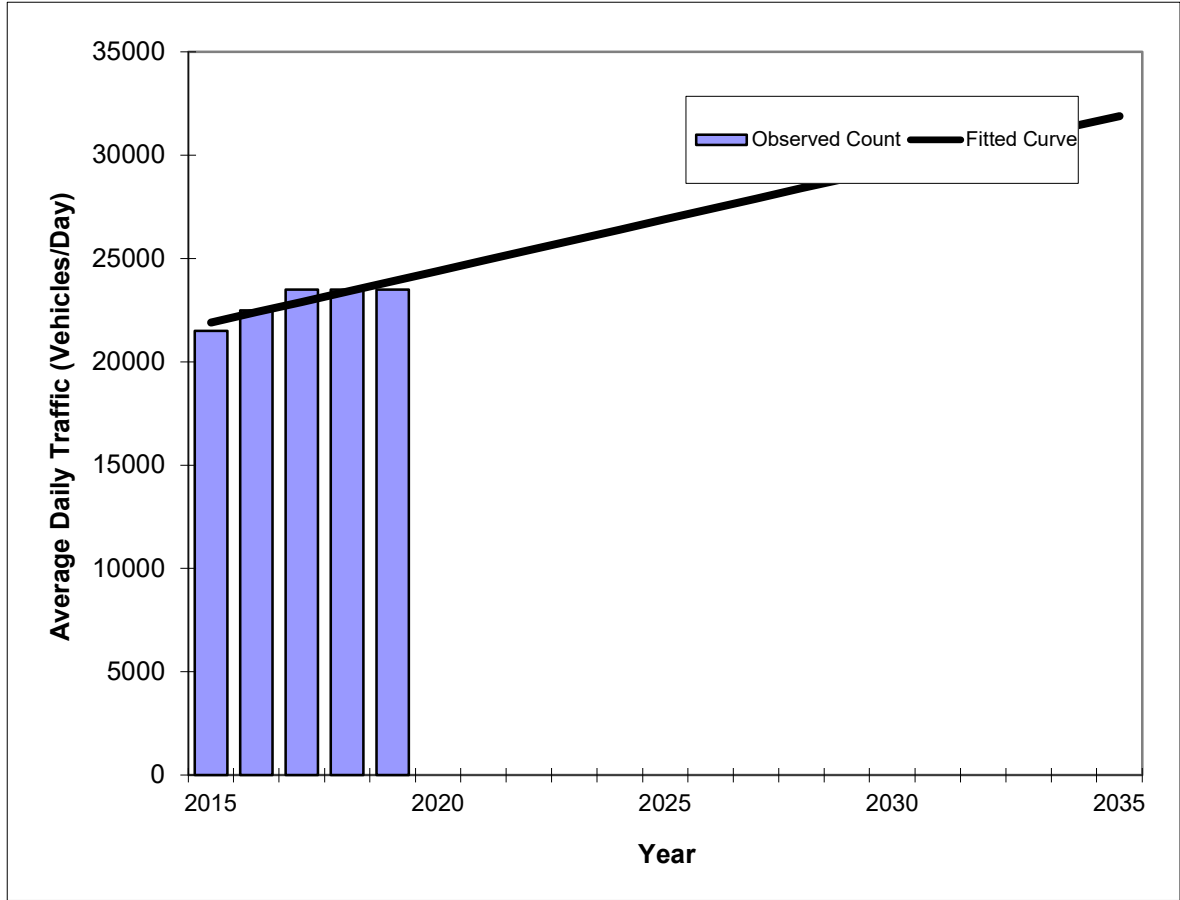

Year	Traffic (ADT/AADT)	
	Count*	Trend**
2015	21500	21900
2016	22500	22400
2017	23500	22900
2018	23500	23400
2019	23500	23900
2022 Opening Year Trend		
2022	N/A	25400
2023 Mid-Year Trend		
2023	N/A	25900
2025 Design Year Trend		
2025	N/A	26900
TRANPLAN Forecasts/Trends		

** Annual Trend Increase:	500
Trend R-squared:	78.13%
Trend Annual Historic Growth Rate:	2.28%
Trend Growth Rate (2019 to Design Year):	2.09%
Printed:	11-May-22

Straight Line Growth Option

*Axle-Adjusted

Traffic Trends - V03.a

ROCK ISLAND RD -- S OF ROYAL PALM BLVD

FIN#	0
Location	7

County:	BROWARD
Station #:	7593
Highway:	ROCK ISLAND RD

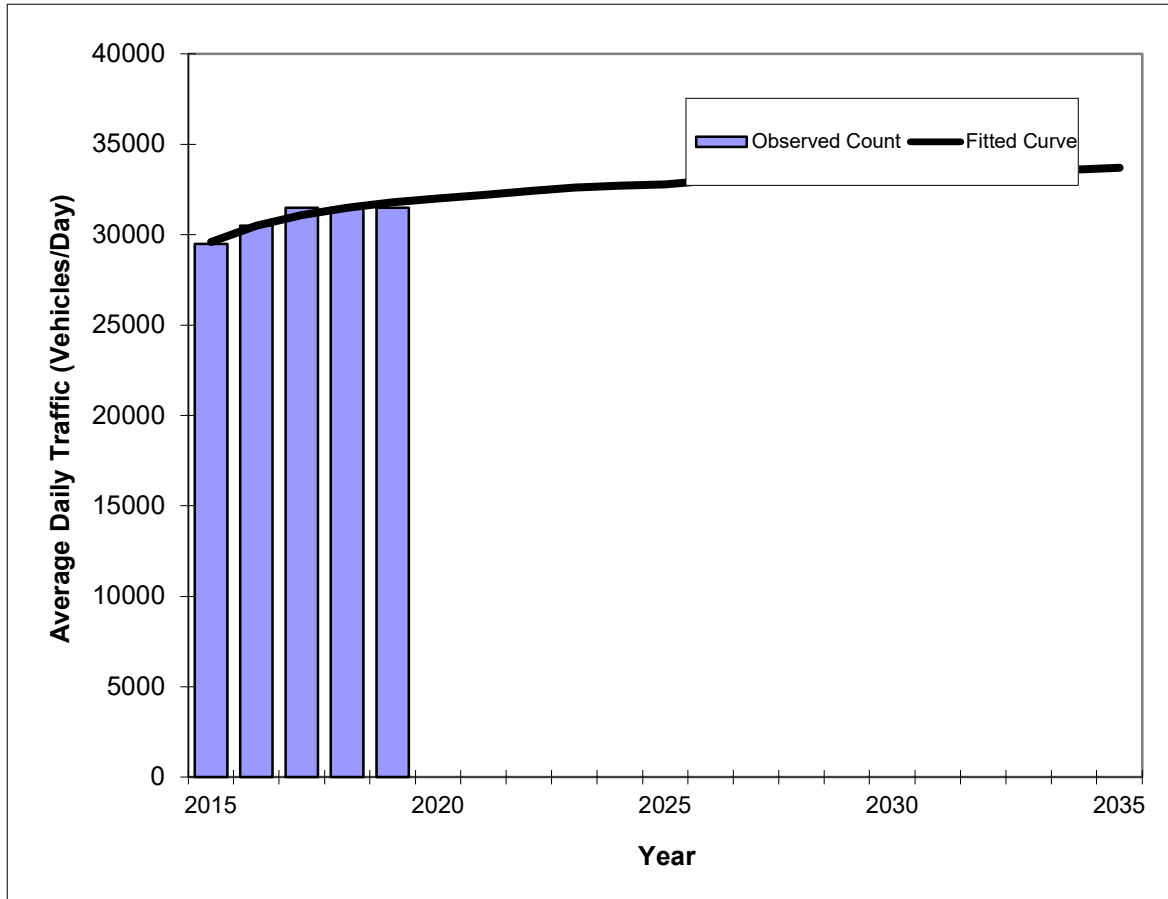

Year	Traffic (ADT/AADT)	
	Count*	Trend**
2015	29500	29600
2016	30500	30500
2017	31500	31100
2018	31500	31500
2019	31500	31800
2022 Opening Year Trend		
2022	N/A	32400
2023 Mid-Year Trend		
2023	N/A	32600
2025 Design Year Trend		
2025	N/A	32800
TRANPLAN Forecasts/Trends		

Trend R-squared:	91.88%
Compounded Annual Historic Growth Rate:	1.81%
Compounded Growth Rate (2019 to Design Year):	0.52%
Printed:	11-May-22
Decaying Exponential Growth Option	

*Axle-Adjusted

Traffic Trends - V03.a

ROCK ISLAND RD -- S OF ROYAL PALM BLVD

FIN#	0
Location	7

County:	BROWARD
Station #:	7593
Highway:	ROCK ISLAND RD

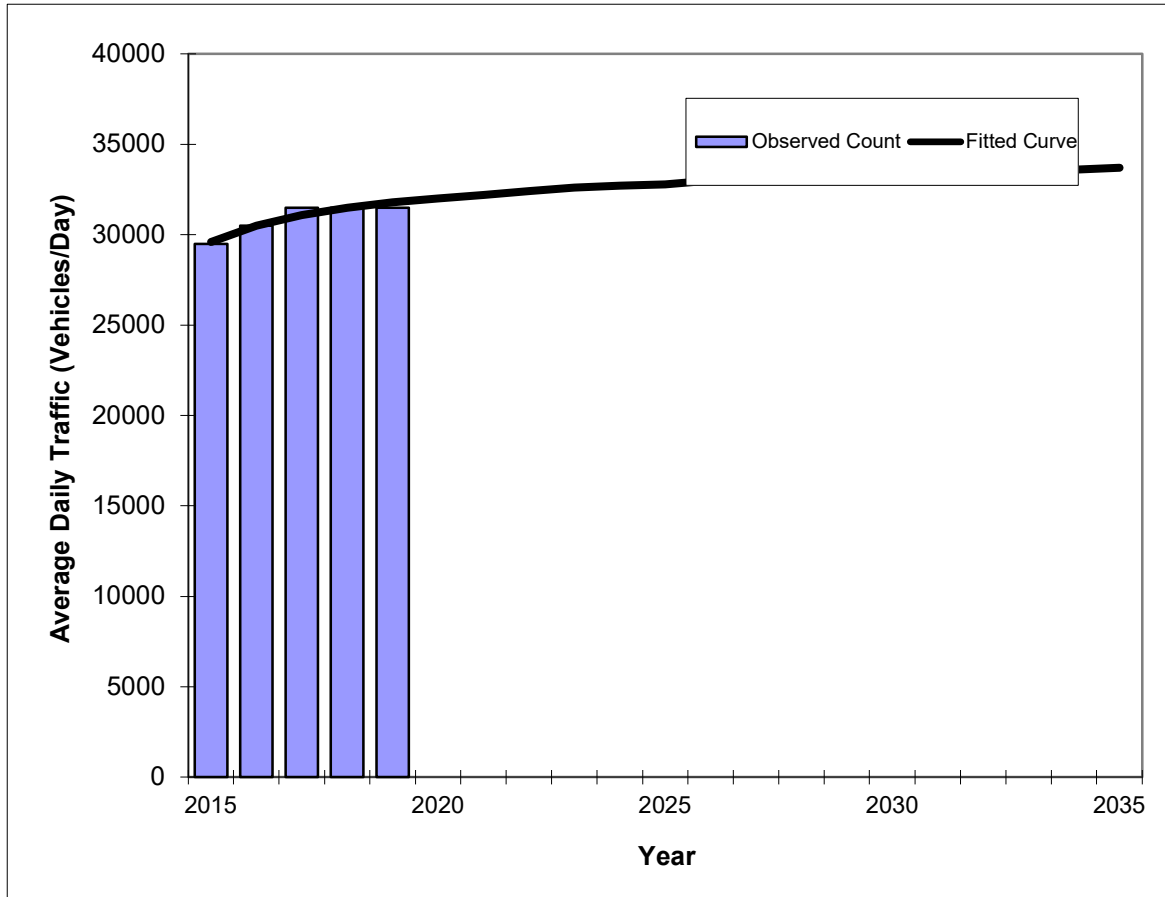

Year	Traffic (ADT/AADT)	
	Count*	Trend**
2015	29500	29600
2016	30500	30500
2017	31500	31100
2018	31500	31500
2019	31500	31800
2022 Opening Year Trend		
2022	N/A	32400
2023 Mid-Year Trend		
2023	N/A	32600
2025 Design Year Trend		
2025	N/A	32800
TRANPLAN Forecasts/Trends		

Trend R-squared:	77.93%
Compounded Annual Historic Growth Rate:	1.81%
Compounded Growth Rate (2019 to Design Year):	0.52%
Printed:	11-May-22
Exponential Growth Option	

*Axle-Adjusted

Traffic Trends - V03.a

ROCK ISLAND RD -- S OF ROYAL PALM BLVD

FIN#	0
Location	7

County:	BROWARD
Station #:	7593
Highway:	ROCK ISLAND RD

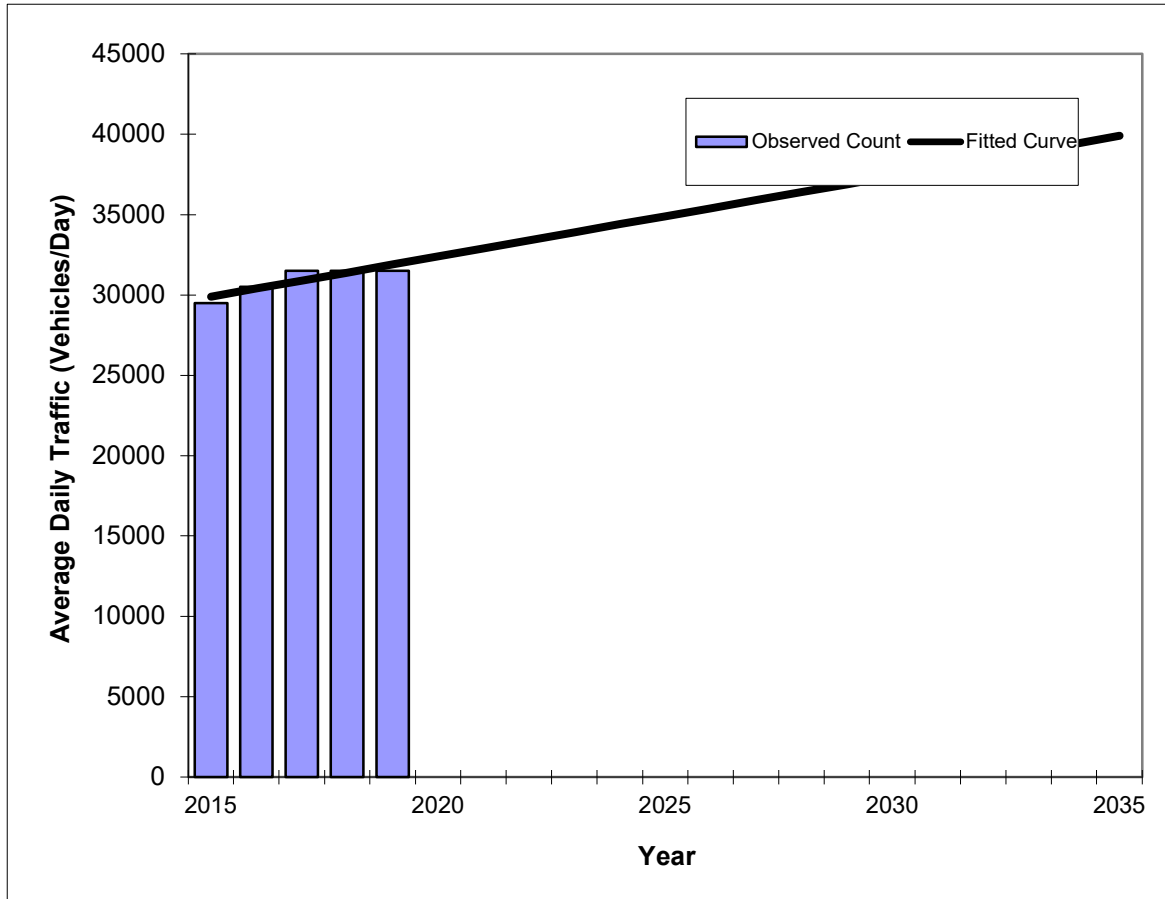

Year	Traffic (ADT/AADT)	
	Count*	Trend**
2015	29500	29900
2016	30500	30400
2017	31500	30900
2018	31500	31400
2019	31500	31900
2022 Opening Year Trend		
2022	N/A	33400
2023 Mid-Year Trend		
2023	N/A	33900
2025 Design Year Trend		
2025	N/A	34900
TRANPLAN Forecasts/Trends		

** Annual Trend Increase:	500
Trend R-squared:	78.13%
Trend Annual Historic Growth Rate:	1.67%
Trend Growth Rate (2019 to Design Year):	1.57%
Printed:	11-May-22
Straight Line Growth Option	

*Axle-Adjusted

Traffic Trends - V03.a

ATLANTIC BLVD -- W OF ROCK ISLAND RD

FIN#	0
Location	8

County:	BROWARD
Station #:	7621
Highway:	ATLANTIC BLVD

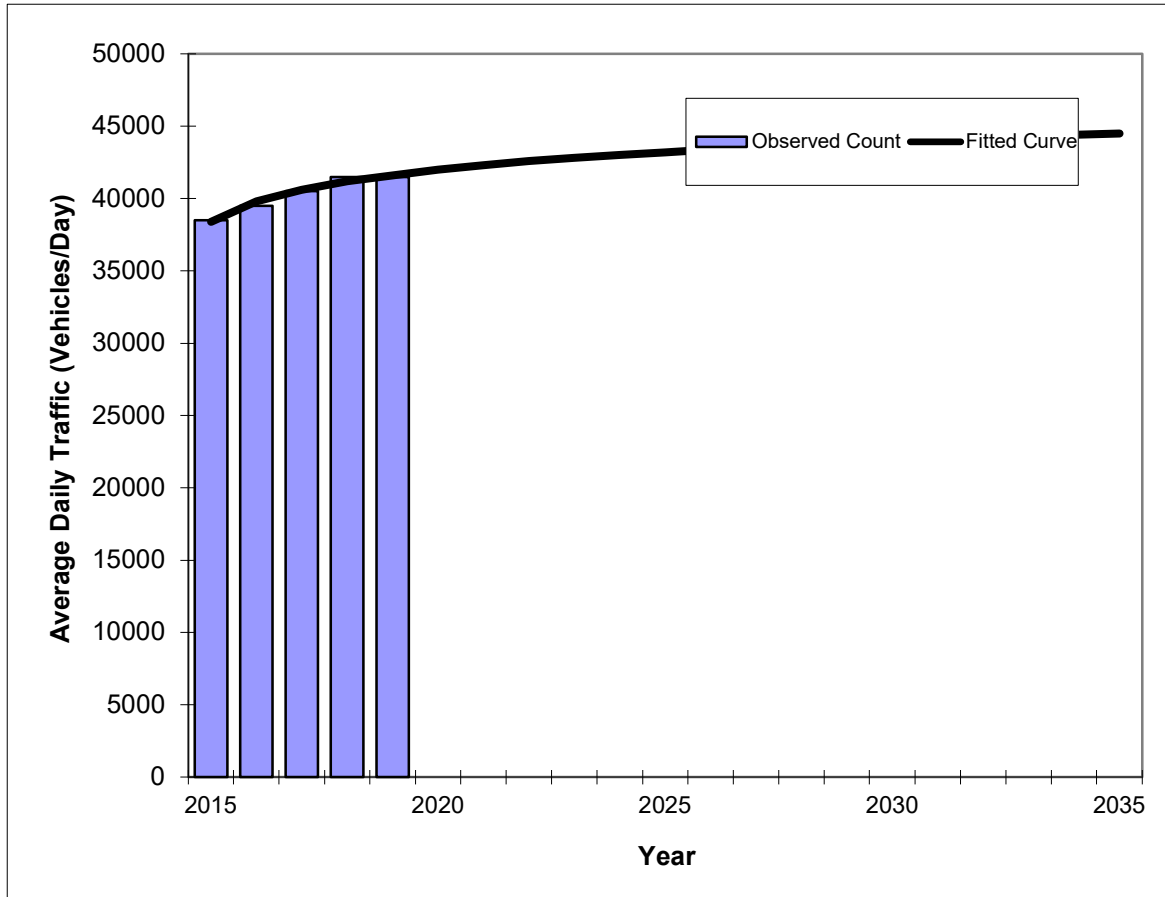

Year	Traffic (ADT/AADT)	
	Count*	Trend**
2015	38500	38400
2016	39500	39800
2017	40500	40600
2018	41500	41200
2019	41500	41600
2022 Opening Year Trend		
2022	N/A	42600
2023 Mid-Year Trend		
2023	N/A	42800
2025 Design Year Trend		
2025	N/A	43200
TRANPLAN Forecasts/Trends		

Trend R-squared:	96.75%
Compounded Annual Historic Growth Rate:	2.02%
Compounded Growth Rate (2019 to Design Year):	0.63%
Printed:	11-May-22
Decaying Exponential Growth Option	

*Axle-Adjusted

Traffic Trends - V03.a

ATLANTIC BLVD -- W OF ROCK ISLAND RD

FIN#	0
Location	8

County:	BROWARD
Station #:	7621
Highway:	ATLANTIC BLVD

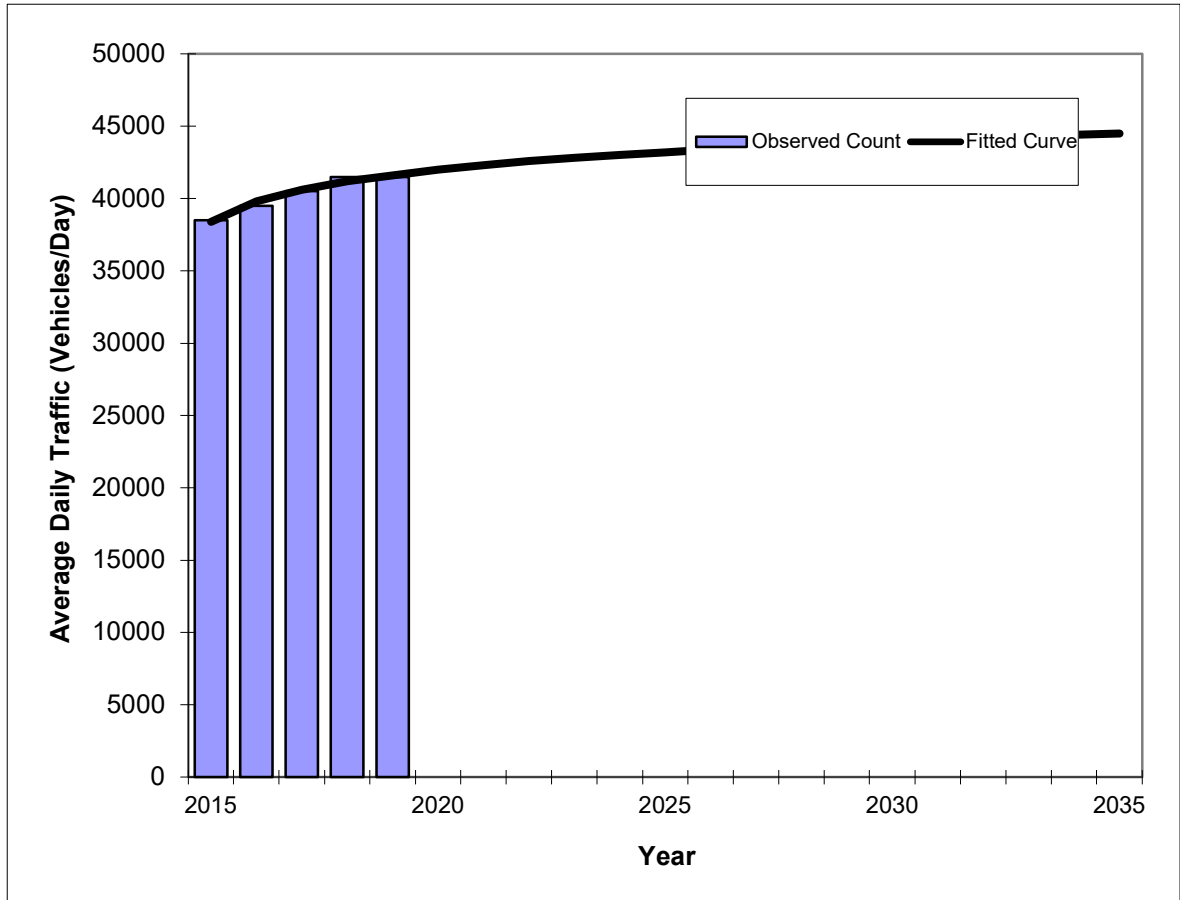

Year	Traffic (ADT/AADT)	
	Count*	Trend**
2015	38500	38400
2016	39500	39800
2017	40500	40600
2018	41500	41200
2019	41500	41600
2022 Opening Year Trend		
2022	N/A	42600
2023 Mid-Year Trend		
2023	N/A	42800
2025 Design Year Trend		
2025	N/A	43200
TRANPLAN Forecasts/Trends		

Trend R-squared:	93.94%
Compounded Annual Historic Growth Rate:	2.02%
Compounded Growth Rate (2019 to Design Year):	0.63%
Printed:	11-May-22
Exponential Growth Option	

*Axle-Adjusted

Traffic Trends - V03.a

ATLANTIC BLVD -- W OF ROCK ISLAND RD

FIN#	0
Location	8

County:	BROWARD
Station #:	7621
Highway:	ATLANTIC BLVD

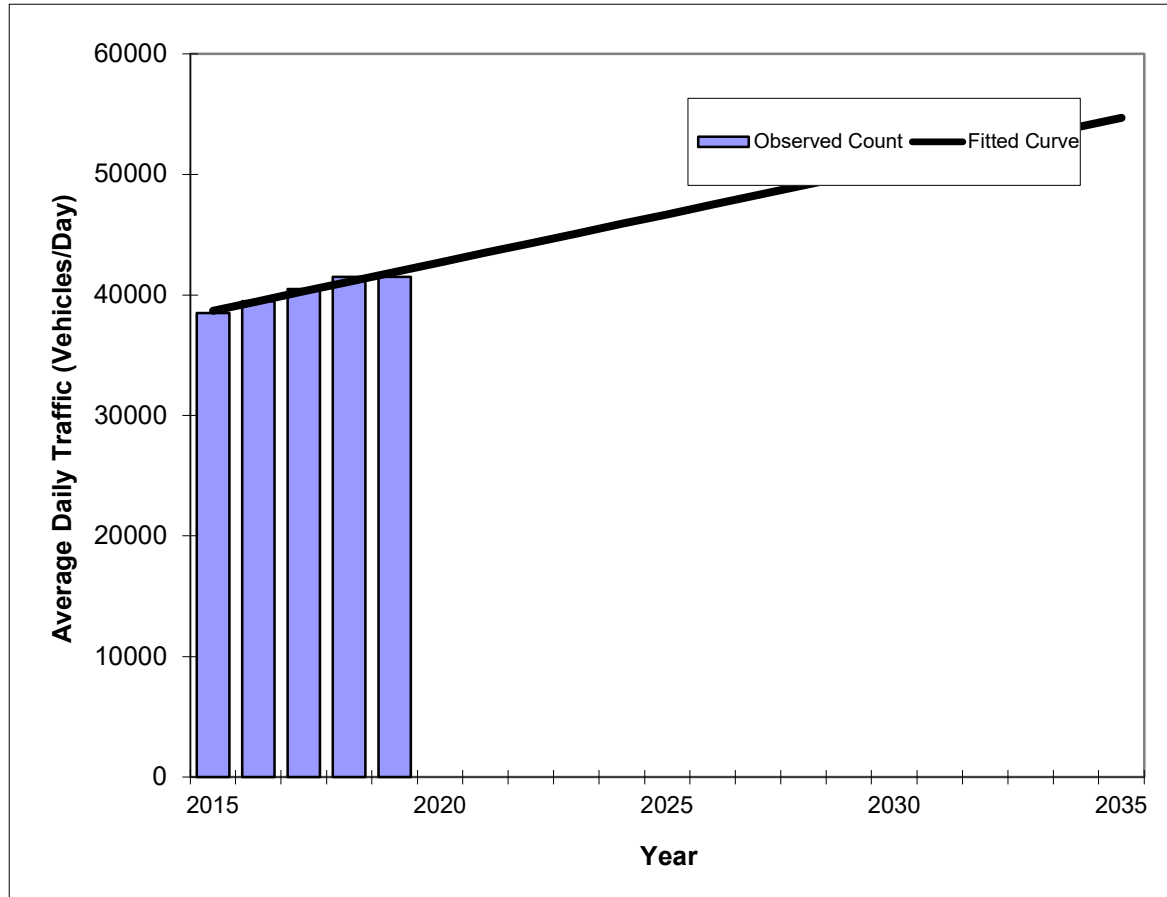

Year	Traffic (ADT/AADT)	
	Count*	Trend**
2015	38500	38700
2016	39500	39500
2017	40500	40300
2018	41500	41100
2019	41500	41900
2022 Opening Year Trend		
2022	N/A	44300
2023 Mid-Year Trend		
2023	N/A	45100
2025 Design Year Trend		
2025	N/A	46700
TRANPLAN Forecasts/Trends		

** Annual Trend Increase:	800
Trend R-squared:	94.12%
Trend Annual Historic Growth Rate:	2.07%
Trend Growth Rate (2019 to Design Year):	1.91%
Printed:	11-May-22
Straight Line Growth Option	

*Axle-Adjusted

Traffic Trends - V03.a

ATLANTIC BLVD -- E OF RIVERSIDE DR

FIN#	0
Location	9

County:	BROWARD
Station #:	9199
Highway:	ATLANTIC BLVD

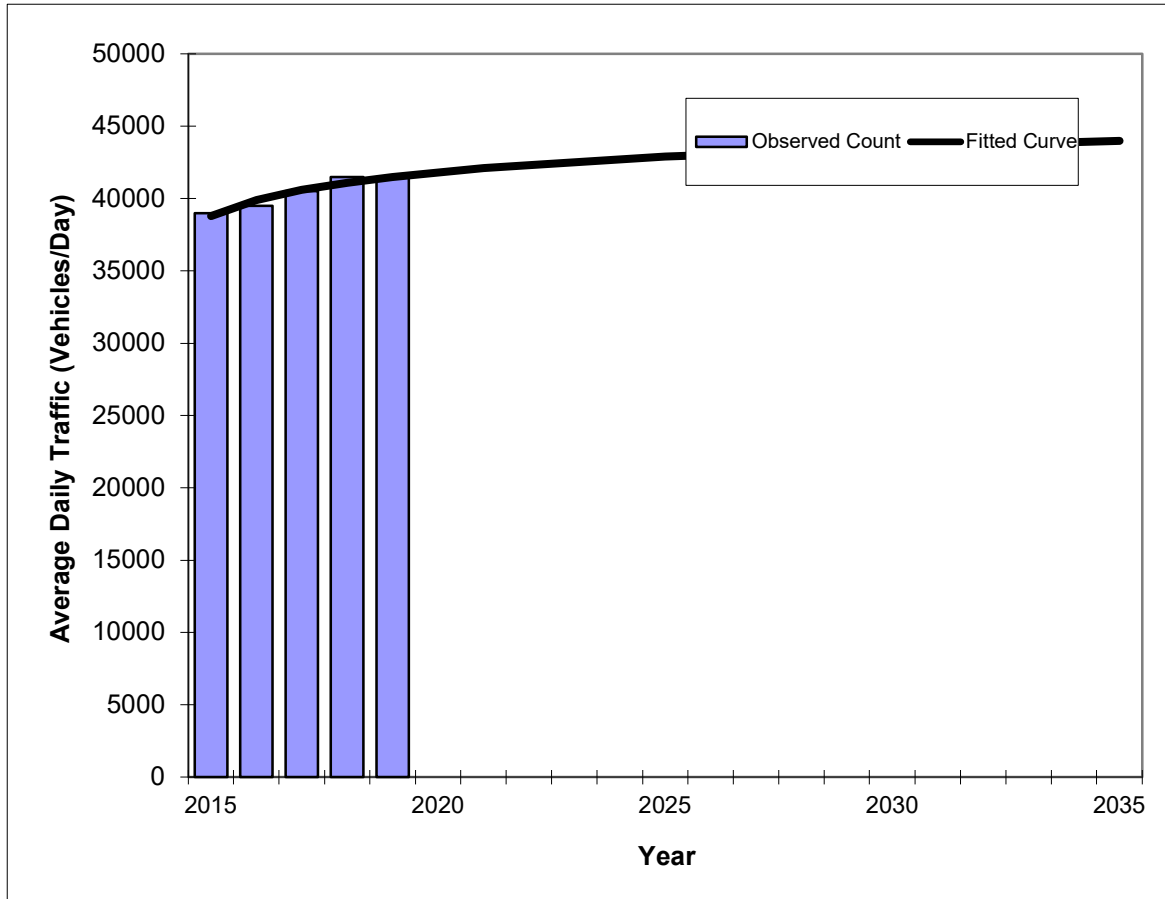

Year	Traffic (ADT/AADT)	
	Count*	Trend**
2015	39000	38800
2016	39500	39900
2017	40500	40600
2018	41500	41100
2019	41500	41500
2022 Opening Year Trend		
2022	N/A	42300
2023 Mid-Year Trend		
2023	N/A	42500
2025 Design Year Trend		
2025	N/A	42900
TRANPLAN Forecasts/Trends		

Trend R-squared:	92.09%
Compounded Annual Historic Growth Rate:	1.70%
Compounded Growth Rate (2019 to Design Year):	0.55%
Printed:	11-May-22
Decaying Exponential Growth Option	

*Axle-Adjusted

Traffic Trends - V03.a

ATLANTIC BLVD -- E OF RIVERSIDE DR

FIN#	0
Location	9

County:	BROWARD
Station #:	9199
Highway:	ATLANTIC BLVD

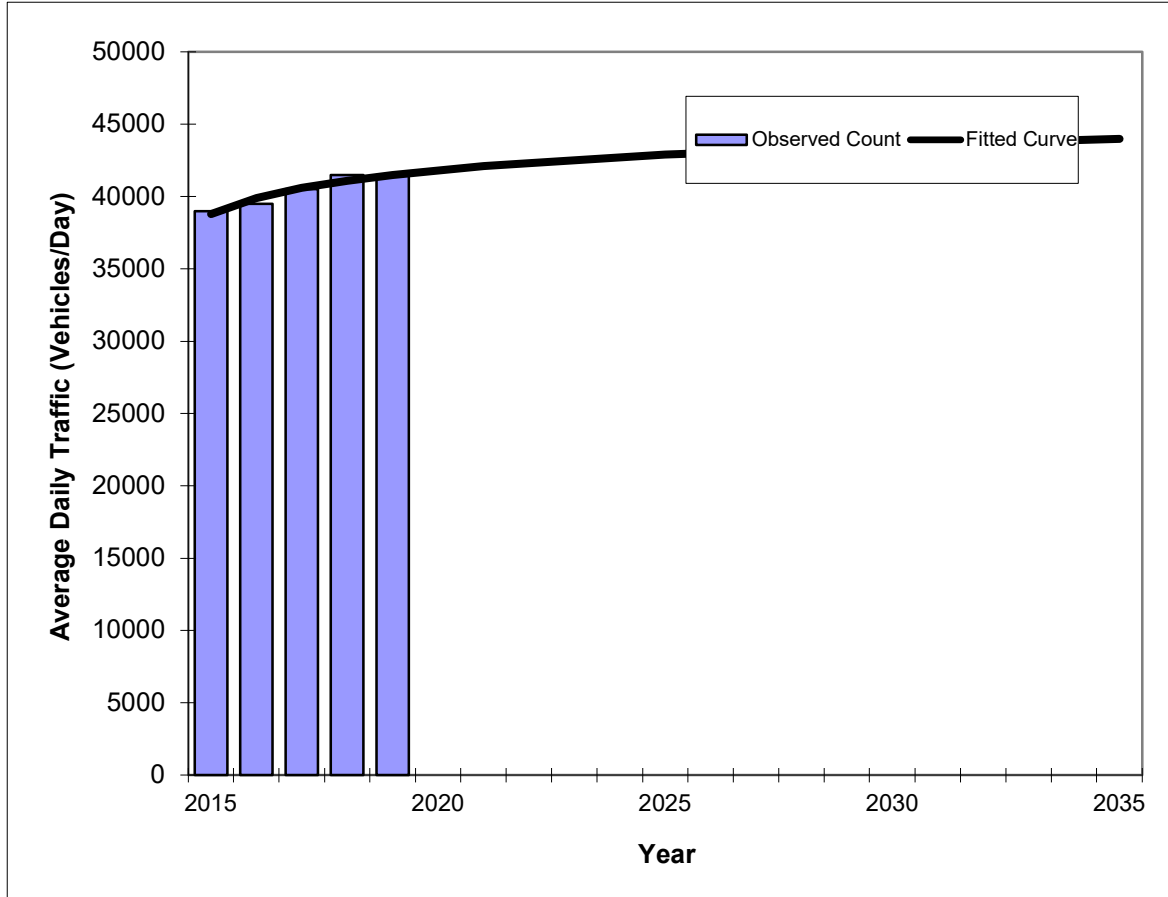

Year	Traffic (ADT/AADT)	
	Count*	Trend**
2015	39000	38800
2016	39500	39900
2017	40500	40600
2018	41500	41100
2019	41500	41500
2022 Opening Year Trend		
2022	N/A	42300
2023 Mid-Year Trend		
2023	N/A	42500
2025 Design Year Trend		
2025	N/A	42900
TRANPLAN Forecasts/Trends		

Trend R-squared:	94.23%
Compounded Annual Historic Growth Rate:	1.70%
Compounded Growth Rate (2019 to Design Year):	0.55%
Printed:	11-May-22
Exponential Growth Option	

*Axle-Adjusted

Traffic Trends - V03.a
ATLANTIC BLVD -- E OF RIVERSIDE DR

FIN#	0
Location	9

County:	BROWARD
Station #:	9199
Highway:	ATLANTIC BLVD

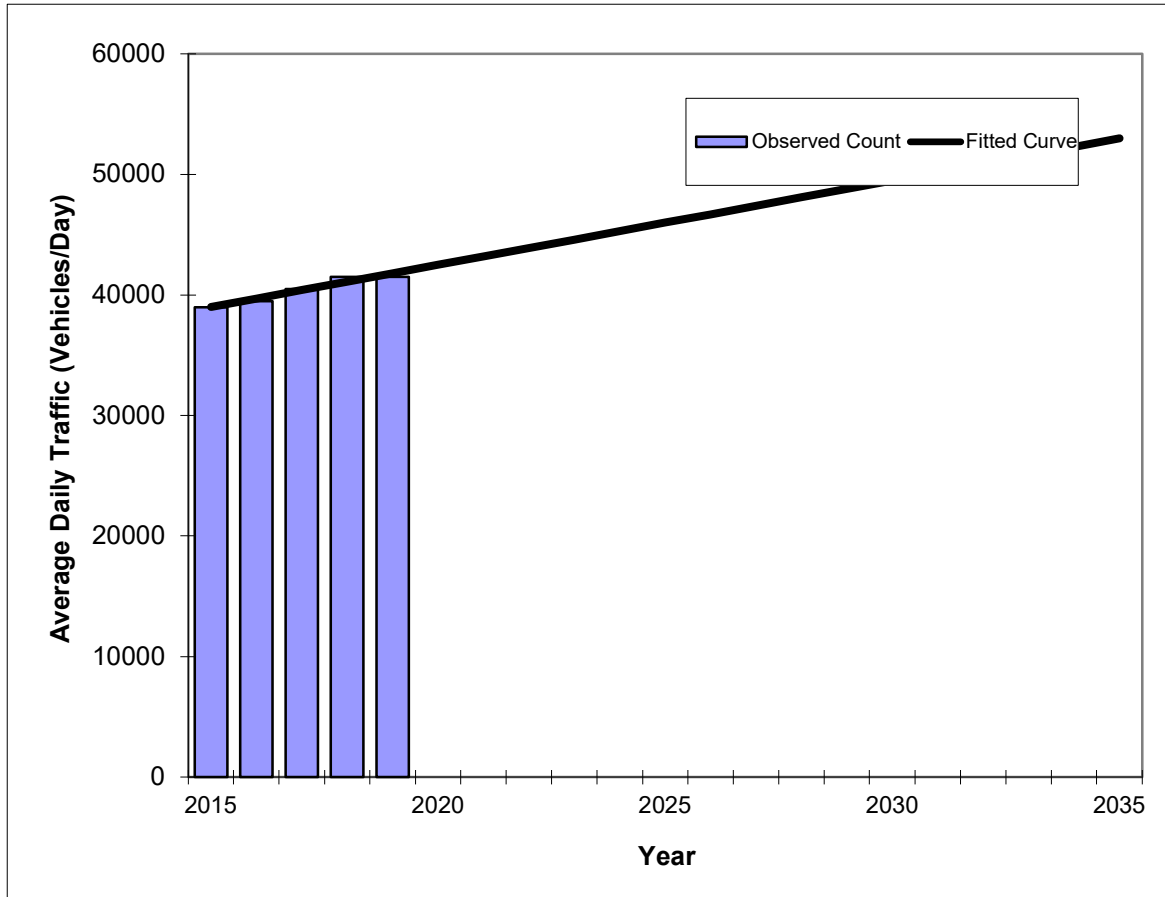

Year	Traffic (ADT/AADT)	
	Count*	Trend**
2015	39000	39000
2016	39500	39700
2017	40500	40400
2018	41500	41100
2019	41500	41800
2022 Opening Year Trend		
2022	N/A	43900
2023 Mid-Year Trend		
2023	N/A	44600
2025 Design Year Trend		
2025	N/A	46000
TRANPLAN Forecasts/Trends		

** Annual Trend Increase:	700
Trend R-squared:	94.23%
Trend Annual Historic Growth Rate:	1.79%
Trend Growth Rate (2019 to Design Year):	1.67%
Printed:	11-May-22
Straight Line Growth Option	

*Axle-Adjusted

Traffic Trends - V03.a

ATLANTIC BLVD -- E OF RIVERSIDE DR

FIN#	0
Location	10

County:	BROWARD
Station #:	9200
Highway:	ATLANTIC BLVD

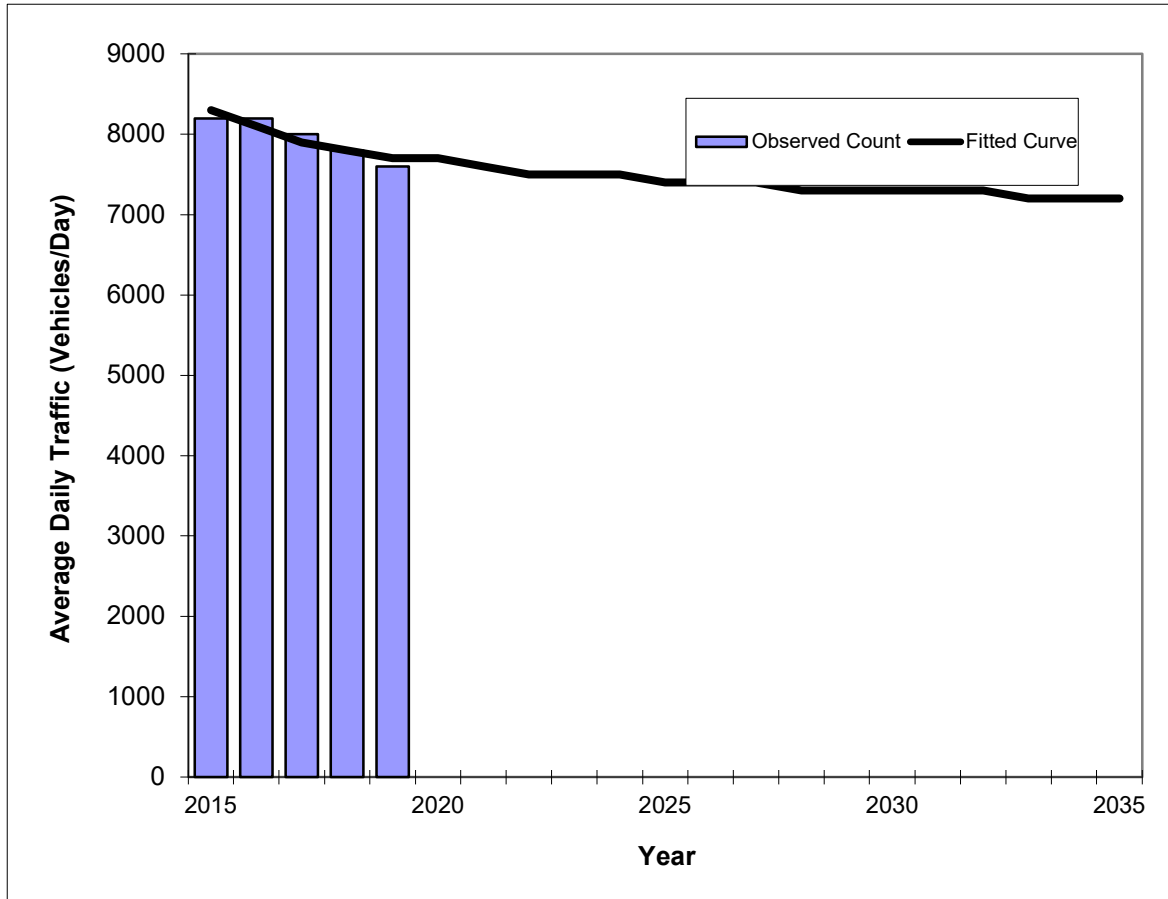

Year	Traffic (ADT/AADT)	
	Count*	Trend**
2015	8200	8300
2016	8200	8100
2017	8000	7900
2018	7800	7800
2019	7600	7700
2022 Opening Year Trend		
2022	N/A	7500
2023 Mid-Year Trend		
2023	N/A	7500
2025 Design Year Trend		
2025	N/A	7400
TRANPLAN Forecasts/Trends		

Trend R-squared:	79.46%
Compounded Annual Historic Growth Rate:	-1.86%
Compounded Growth Rate (2019 to Design Year):	-0.66%
Printed:	11-May-22
Decaying Exponential Growth Option	

*Axle-Adjusted

Traffic Trends - V03.a

ATLANTIC BLVD -- E OF RIVERSIDE DR

FIN#	0
Location	10

County:	BROWARD
Station #:	9200
Highway:	ATLANTIC BLVD

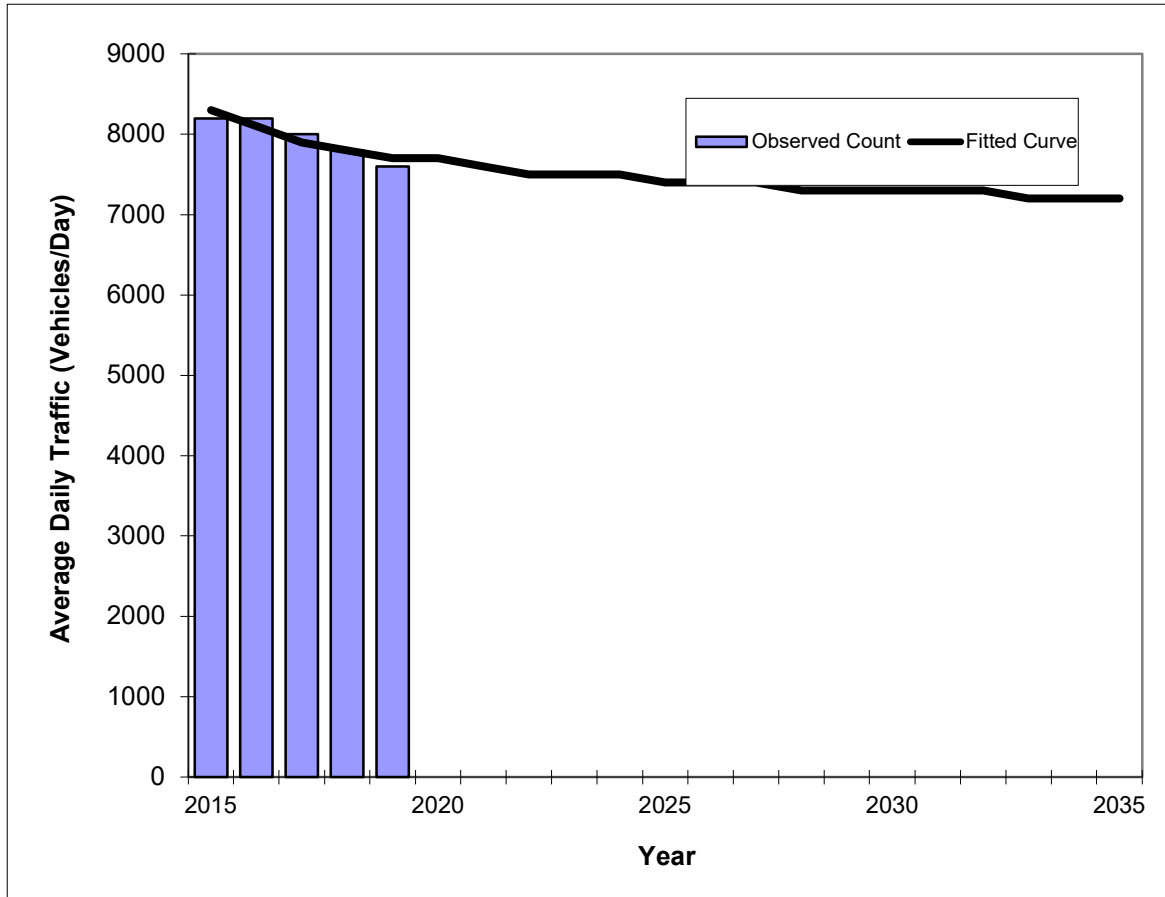

Year	Traffic (ADT/AADT)	
	Count*	Trend**
2015	8200	8300
2016	8200	8100
2017	8000	7900
2018	7800	7800
2019	7600	7700
2022 Opening Year Trend		
2022	N/A	7500
2023 Mid-Year Trend		
2023	N/A	7500
2025 Design Year Trend		
2025	N/A	7400
TRANPLAN Forecasts/Trends		

Trend R-squared:	93.93%
Compounded Annual Historic Growth Rate:	-1.86%
Compounded Growth Rate (2019 to Design Year):	-0.66%
Printed:	11-May-22
Exponential Growth Option	

*Axle-Adjusted

Traffic Trends - V03.a

ATLANTIC BLVD -- E OF RIVERSIDE DR

FIN#	0
Location	10

County:	BROWARD
Station #:	9200
Highway:	ATLANTIC BLVD

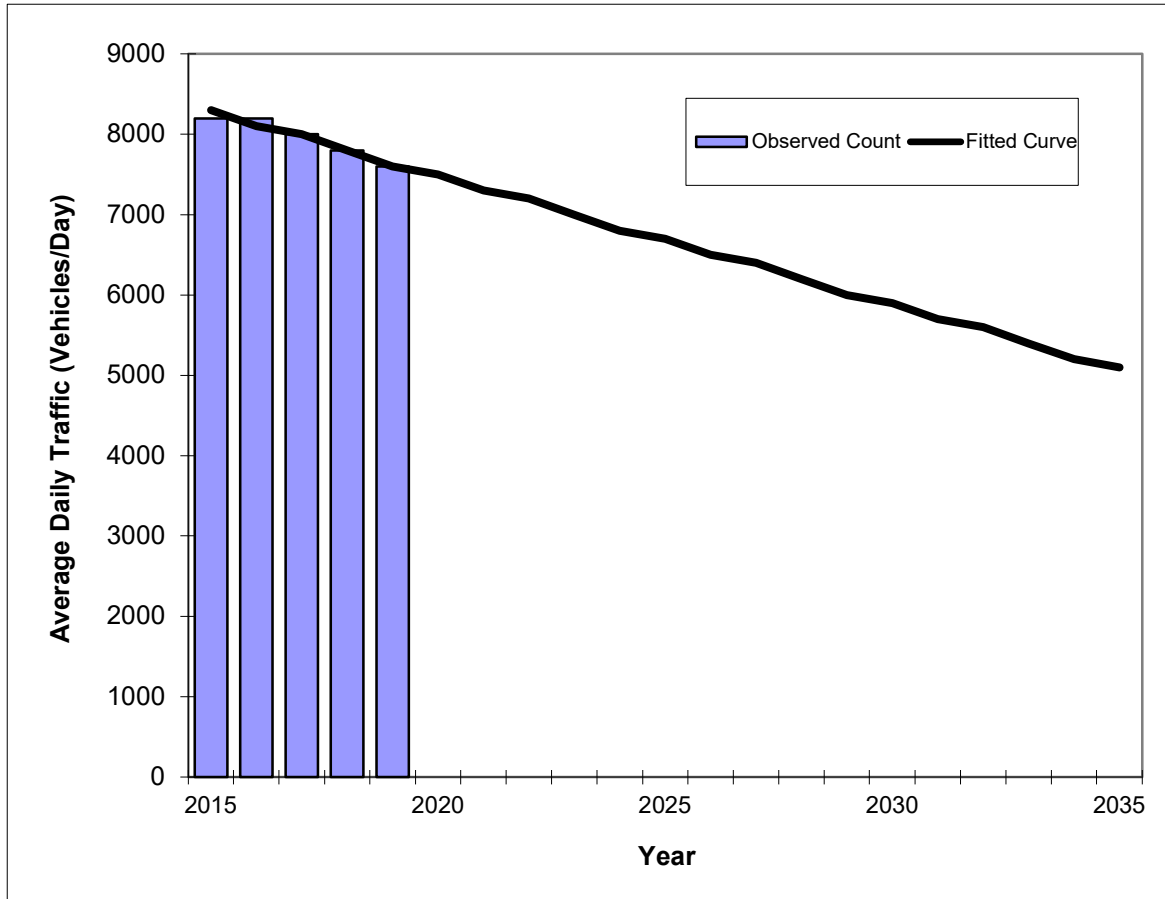

Year	Traffic (ADT/AADT)	
	Count*	Trend**
2015	8200	8300
2016	8200	8100
2017	8000	8000
2018	7800	7800
2019	7600	7600
2022 Opening Year Trend		
2022	N/A	7200
2023 Mid-Year Trend		
2023	N/A	7000
2025 Design Year Trend		
2025	N/A	6700
TRANPLAN Forecasts/Trends		

** Annual Trend Increase:	-160
Trend R-squared:	94.12%
Trend Annual Historic Growth Rate:	-2.11%
Trend Growth Rate (2019 to Design Year):	-1.97%
Printed:	11-May-22
Straight Line Growth Option	

*Axle-Adjusted

Traffic Trends - V03.a

RAMBLEWOOD DRIVE -- N OF ATLANTIC BLVD

FIN#	0
Location	11

County:	BROWARD
Station #:	9343
Highway:	RAMBLEWOOD DRIVE

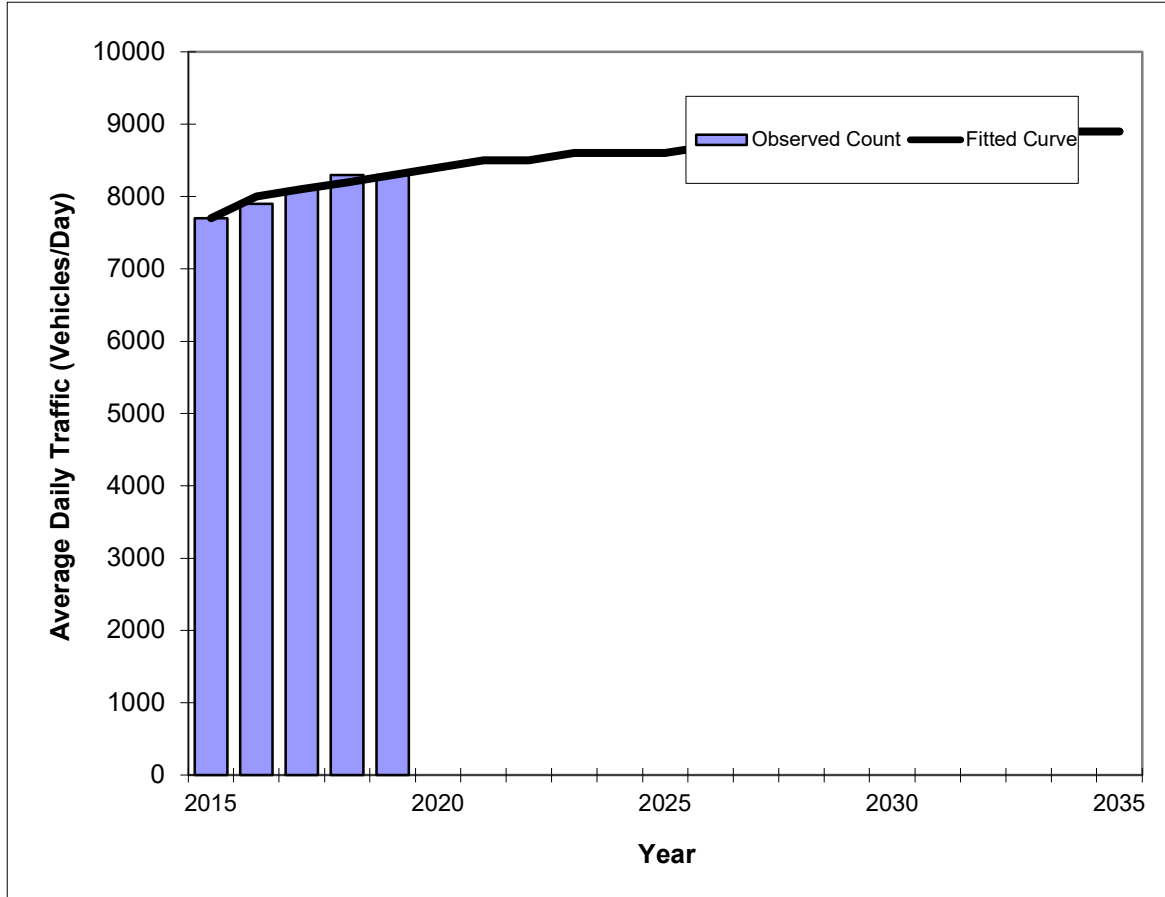

Year	Traffic (ADT/AADT)	
	Count*	Trend**
2015	7700	7700
2016	7900	8000
2017	8100	8100
2018	8300	8200
2019	8300	8300
2022 Opening Year Trend		
2022	N/A	8500
2023 Mid-Year Trend		
2023	N/A	8600
2025 Design Year Trend		
2025	N/A	8600
TRANPLAN Forecasts/Trends		

Trend R-squared:	96.75%
Compounded Annual Historic Growth Rate:	1.89%
Compounded Growth Rate (2019 to Design Year):	0.59%
Printed:	11-May-22
Decaying Exponential Growth Option	

*Axle-Adjusted

Traffic Trends - V03.a

RAMBLEWOOD DRIVE -- N OF ATLANTIC BLVD

FIN#	0
Location	11

County:	BROWARD
Station #:	9343
Highway:	RAMBLEWOOD DRIVE

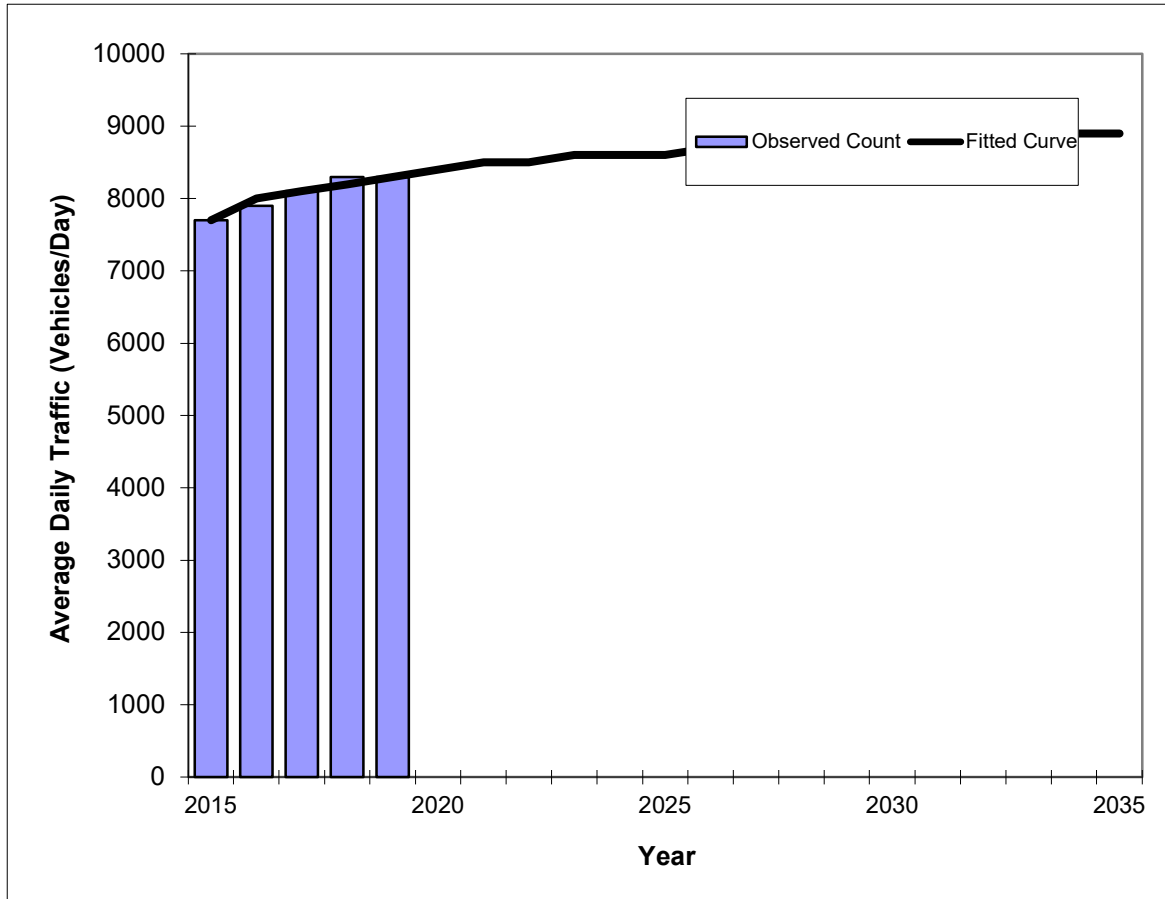

Year	Traffic (ADT/AADT)	
	Count*	Trend**
2015	7700	7700
2016	7900	8000
2017	8100	8100
2018	8300	8200
2019	8300	8300
2022 Opening Year Trend		
2022	N/A	8500
2023 Mid-Year Trend		
2023	N/A	8600
2025 Design Year Trend		
2025	N/A	8600
TRANPLAN Forecasts/Trends		

Trend R-squared:	93.94%
Compounded Annual Historic Growth Rate:	1.89%
Compounded Growth Rate (2019 to Design Year):	0.59%
Printed:	11-May-22
Exponential Growth Option	

*Axle-Adjusted

Traffic Trends - V03.a

RAMBLEWOOD DRIVE -- N OF ATLANTIC BLVD

FIN#	0
Location	11

County:	BROWARD
Station #:	9343
Highway:	RAMBLEWOOD DRIVE

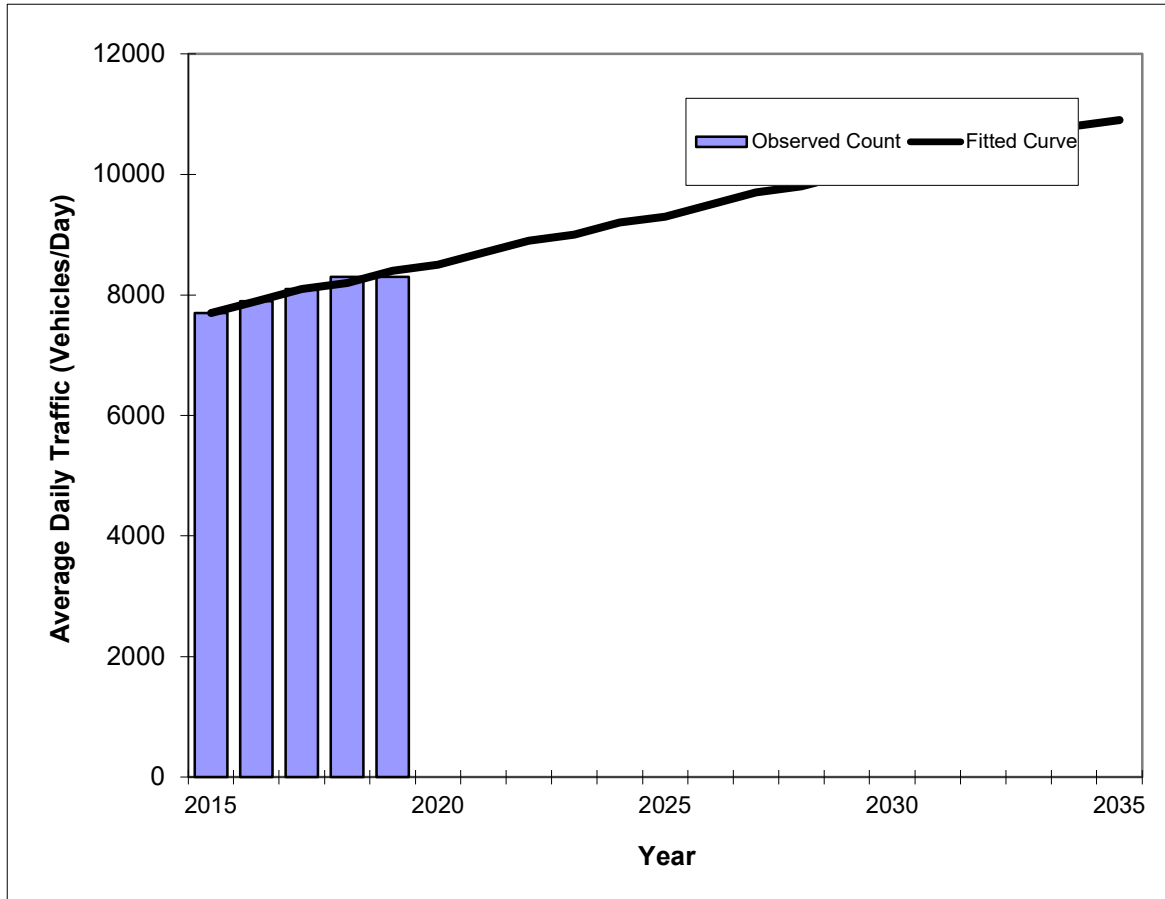

Year	Traffic (ADT/AADT)	
	Count*	Trend**
2015	7700	7700
2016	7900	7900
2017	8100	8100
2018	8300	8200
2019	8300	8400
2022 Opening Year Trend		
2022	N/A	8900
2023 Mid-Year Trend		
2023	N/A	9000
2025 Design Year Trend		
2025	N/A	9300
TRANPLAN Forecasts/Trends		

** Annual Trend Increase:	160
Trend R-squared:	94.12%
Trend Annual Historic Growth Rate:	2.27%
Trend Growth Rate (2019 to Design Year):	1.79%
Printed:	11-May-22
Straight Line Growth Option	

*Axle-Adjusted

Traffic Trends - V03.a

MARGATE BLVD -- W OF ROCK ISLAND RD

FIN#	0
Location	12

County:	BROWARD
Station #:	9595
Highway:	MARGATE BLVD

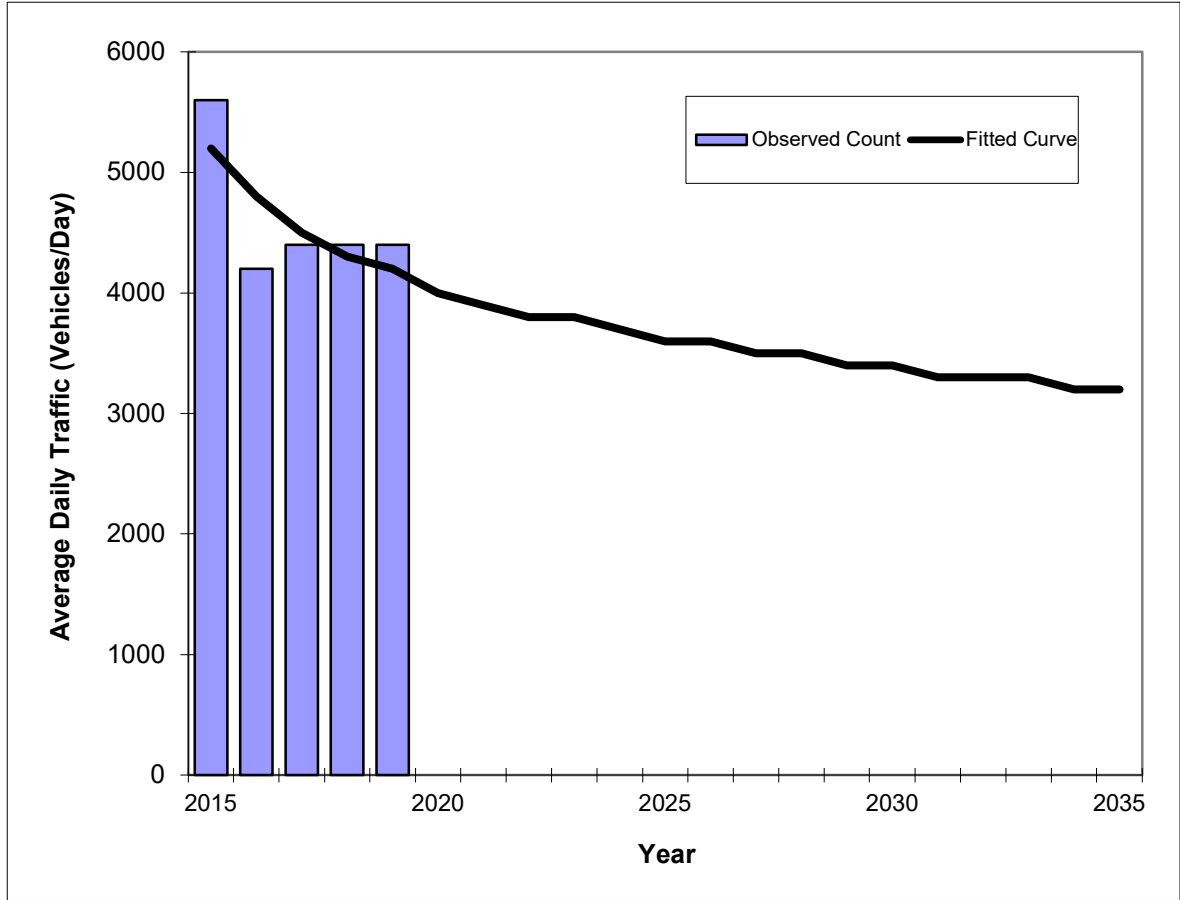

Year	Traffic (ADT/AADT)	
	Count*	Trend**
2015	5600	5200
2016	4200	4800
2017	4400	4500
2018	4400	4300
2019	4400	4200
2022 Opening Year Trend		
2022	N/A	3800
2023 Mid-Year Trend		
2023	N/A	3800
2025 Design Year Trend		
2025	N/A	3600
TRANPLAN Forecasts/Trends		

Trend R-squared:	58.10%
Compounded Annual Historic Growth Rate:	-5.20%
Compounded Growth Rate (2019 to Design Year):	-2.54%
Printed:	11-May-22
Decaying Exponential Growth Option	

*Axle-Adjusted

Traffic Trends - V03.a

MARGATE BLVD -- W OF ROCK ISLAND RD

FIN#	0
Location	12

County:	BROWARD
Station #:	9595
Highway:	MARGATE BLVD

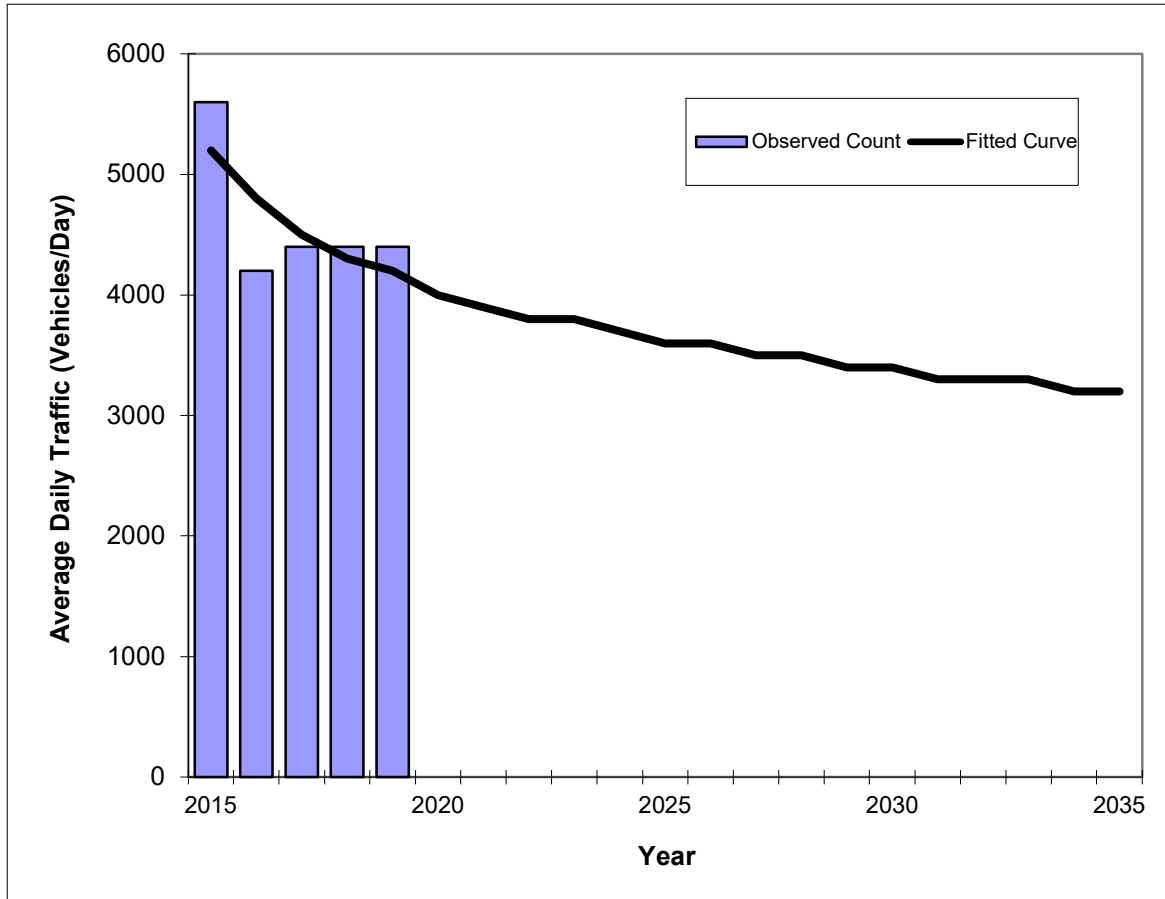

Year	Traffic (ADT/AADT)	
	Count*	Trend**
2015	5600	5200
2016	4200	4800
2017	4400	4500
2018	4400	4300
2019	4400	4200
2022 Opening Year Trend		
2022	N/A	3800
2023 Mid-Year Trend		
2023	N/A	3800
2025 Design Year Trend		
2025	N/A	3600
TRANPLAN Forecasts/Trends		

Trend R-squared:	36.01%
Compounded Annual Historic Growth Rate:	-5.20%
Compounded Growth Rate (2019 to Design Year):	-2.54%
Printed:	11-May-22
Exponential Growth Option	

*Axle-Adjusted

Traffic Trends - V03.a

MARGATE BLVD -- W OF ROCK ISLAND RD

FIN#	0
Location	12

County:	BROWARD
Station #:	9595
Highway:	MARGATE BLVD

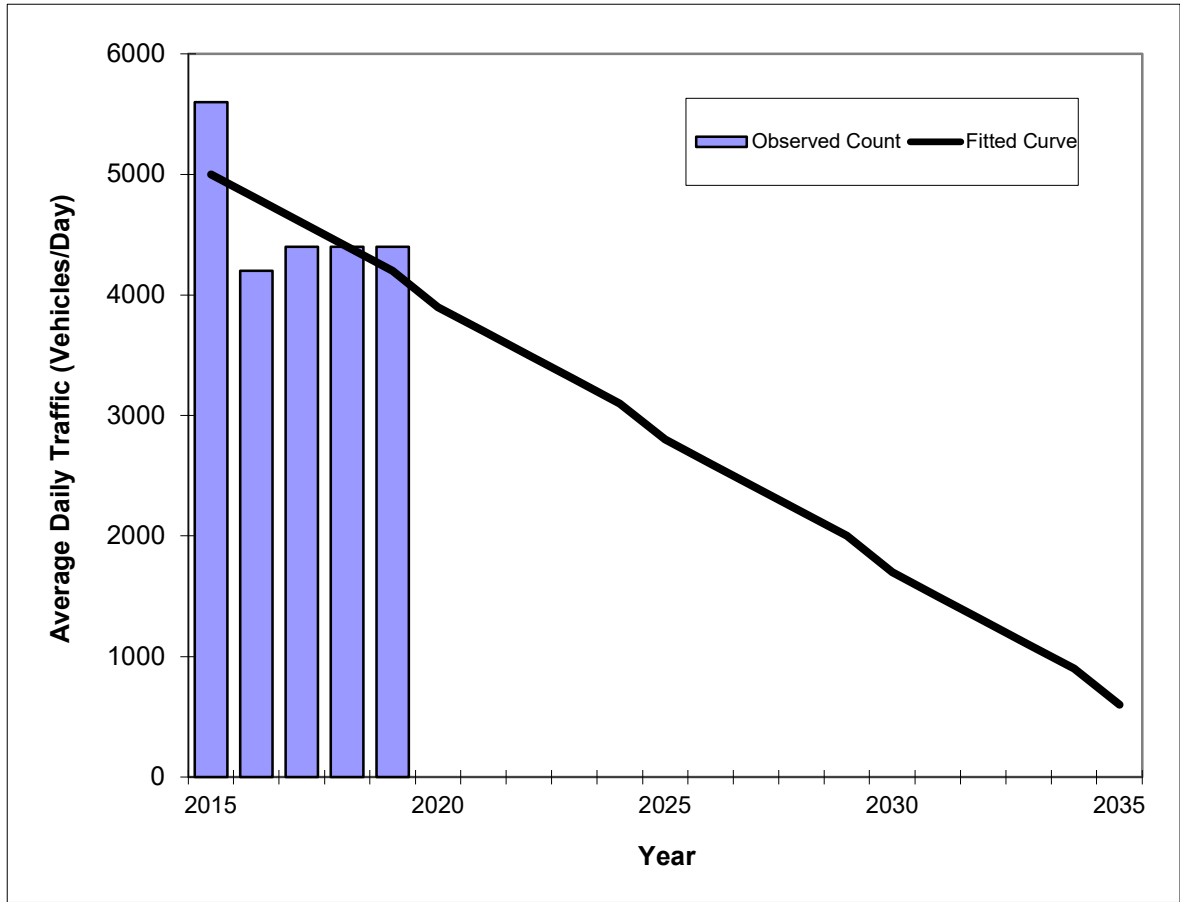

Year	Traffic (ADT/AADT)	
	Count*	Trend**
2015	5600	5000
2016	4200	4800
2017	4400	4600
2018	4400	4400
2019	4400	4200
2022 Opening Year Trend		
2022	N/A	3500
2023 Mid-Year Trend		
2023	N/A	3300
2025 Design Year Trend		
2025	N/A	2800
TRANPLAN Forecasts/Trends		

** Annual Trend Increase:	-220
Trend R-squared:	37.81%
Trend Annual Historic Growth Rate:	-4.00%
Trend Growth Rate (2019 to Design Year):	-5.56%
Printed:	11-May-22
Straight Line Growth Option	

*Axle-Adjusted

Growth Rate Trend Analysis Calculations

Description	0298			5238			7164			7473			7475			7507			7593			7621			9199			9200			9343			Linear	Exponential	Decaying Exponential
	Linear	Exponential	Decaying Exponential	Linear	Exponential	Decaying Exponential	Linear	Exponential	Decaying Exponential	Linear	Exponential	Decaying Exponential	Linear	Exponential	Decaying Exponential	Linear	Exponential	Decaying Exponential	Linear	Exponential	Decaying Exponential	Linear	Exponential	Decaying Exponential	Linear	Exponential	Decaying Exponential	Linear	Exponential	Decaying Exponential						
Trend Growth Rate 5 years	1.17	1.20	1.20	4.62	5.59	5.59	2.37	2.31	2.31	12.13	12.62	12.62	1.86	2.01	2.01	2.28	2.45	2.45	1.67	1.81	1.81	2.07	2.02	2.02	1.79	1.70	1.70	-2.11	-1.86	-1.86	2.27	1.89	1.89	-4.00	-5.20	-5.20
Adjusted Growth Rate 5-years (2)	1.17	1.20	1.20	4.62	5.59	5.59	2.37	2.31	2.31	12.13	12.62	12.62	1.86	2.01	2.01	2.28	2.45	2.45	1.67	1.81	1.81	2.07	2.02	2.02	1.79	1.70	1.70	0.50	0.50	0.50	2.27	1.89	1.89	0.50	0.50	0.50
Trend R-squared 5 years	88.50	88.12	94.83	39.93	41.02	62.52	94.12	93.91	96.75	61.60	59.19	81.20	78.13	77.91	91.88	78.13	77.85	91.88	78.13	77.93	91.88	94.12	93.94	96.75	94.23	94.23	92.09	94.12	93.93	79.46	94.12	93.94	96.75	37.81	36.01	58.10
Growth Rate with highest R-squared (5-year)	1.20			5.59			2.31			12.62			2.01			2.45			1.81			2.02			1.79			0.50			1.89			0.50		
Average Growth Rate (5-year)																															2.89					
Growth Rate Used																															2.89					

Notes:

1: Refer to Trend Analysis Chart

2: If the resulting growth rate is negative, a 0.5 growth rate was used

What is R-squared?

R-squared is a statistical measure of how close the data are to the fitted regression line. It is also known as the coefficient of determination, or the coefficient of multiple determination for multiple regression.

The definition of R-squared is fairly straight-forward; it is the percentage of the response variable variation that is explained by a linear model. Or:

R-squared = Explained variation / Total variation

R-squared is always between 0 and 100%:

0% indicates that the model explains none of the variability of the response data around its mean.

100% indicates that the model explains all the variability of the response data around its mean.

In general, the higher the R-squared, the better the model fits your data. However, there are important conditions for this guideline that I'll talk about both in this post and my next post.

APPENDIX E

Future Turning Movement Volumes

FUTURE TURNING MOVEMENT VOLUME ANALYSIS

Royal Palm Boulevard and Rock Island Road AM Peak Hour

Description	Rock Island Road Northbound			Rock Island Road Southbound			Royal Palm Boulevard Eastbound			Royal Palm Boulevard Westbound		
	Left	Through	Right	Left	Through	Right	Left	Through	Right	Left	Through	Right
Existing Traffic (4/26/2023)	365	585	227	222	662	166	149	908	365	157	756	185
Season Adjustment Factor	1.01	1.01	1.01	1.01	1.01	1.01	1.01	1.01	1.01	1.01	1.01	1.01
2023 Peak Season Traffic	369	591	229	224	669	168	150	917	369	159	764	187
Annual Growth Rate	2.89%	2.89%	2.89%	2.89%	2.89%	2.89%	2.89%	2.89%	2.89%	2.89%	2.89%	2.89%
2025 Background Traffic	390	625	243	237	708	177	159	971	390	168	808	198
Nove of Margate	3	3	2		1				1	1		
2025 Total Traffic	393	628	245	237	709	177	159	971	391	169	808	198

FUTURE TURNING MOVEMENT VOLUME ANALYSIS

Royal Palm Boulevard and Rock Island Road PM Peak Hour

Description	Rock Island Road Northbound			Rock Island Road Southbound			Royal Palm Boulevard Eastbound			Royal Palm Boulevard Westbound		
	Left	Through	Right	Left	Through	Right	Left	Through	Right	Left	Through	Right
Existing Traffic (4/26/2023)	338	599	240	187	704	168	128	526	208	266	907	216
Season Adjustment Factor	1.01	1.01	1.01	1.01	1.01	1.01	1.01	1.01	1.01	1.01	1.01	1.01
2023 Peak Season Traffic	341	605	242	189	711	170	129	531	210	269	916	218
Annual Growth Rate	2.89%	2.89%	2.89%	2.89%	2.89%	2.89%	2.89%	2.89%	2.89%	2.89%	2.89%	2.89%
2025 Background Traffic	361	640	257	200	753	180	137	562	222	284	970	231
Nove of Margate	2	2	1		3				3	2		
2025 Total Traffic	363	642	258	200	756	180	137	562	225	286	970	231

FUTURE TURNING MOVEMENT VOLUME ANALYSIS

**NW 76 Avenue and Margate Boulevard
AM Peak Hour**

Description	NW 76 Avenue Northbound			NW 76 Avenue Southbound			Margate Boulevard Eastbound			Margate Boulevard Westbound		
	Left	Through	Right	Left	Through	Right	Left	Through	Right	Left	Through	Right
Existing Traffic (5/11/2022)	64	0	52					88	137	61	51	
Season Adjustment Factor	1.02	1.02	1.02	1.02	1.02	1.02	1.02	1.02	1.02	1.02	1.02	1.02
2022 Peak Season Traffic	65	0	53	0	0	0	0	90	140	62	52	0
Annual Growth Rate	2.89%	2.89%	2.89%	2.89%	2.89%	2.89%	2.89%	2.89%	2.89%	2.89%	2.89%	2.89%
2025 Background Traffic	71	0	58	0	0	0	0	98	152	68	57	0
Nove of Margate	10							15	34		5	
2025 Total Traffic	81	0	58	0	0	0	0	113	186	68	62	0

FUTURE TURNING MOVEMENT VOLUME ANALYSIS

**NW 76 Avenue and Margate Boulevard
PM Peak Hour**

Description	NW 76 Avenue Northbound			NW 76 Avenue Southbound			Margate Boulevard Eastbound			Margate Boulevard Westbound		
	Left	Through	Right	Left	Through	Right	Left	Through	Right	Left	Through	Right
Existing Traffic (5/11/2022)	136		50					58	79	110	103	
Season Adjustment Factor	1.02	1.02	1.02	1.02	1.02	1.02	1.02	1.02	1.02	1.02	1.02	1.02
2022 Peak Season Traffic	139	0	51	0	0	0	0	59	81	112	105	0
Annual Growth Rate	2.89%	2.89%	2.89%	2.89%	2.89%	2.89%	2.89%	2.89%	2.89%	2.89%	2.89%	2.89%
2025 Background Traffic	151	0	56	0	0	0	0	64	88	122	114	0
Nove of Margate	34							9	19		15	
2025 Total Traffic	185	0	56	0	0	0	0	73	107	122	129	0

FUTURE TURNING MOVEMENT VOLUME ANALYSIS

Rock Island Road and Margate Boulevard AM Peak Hour

Description	Rock Island Road Northbound			Rock Island Road Southbound			Margate Boulevard Eastbound			Margate Boulevard Westbound		
	Left	Through	Right	Left	Through	Right	Left	Through	Right	Left	Through	Right
Existing Traffic (5/11/2022)	12	770	307	162	864	48	57	89	23	136	58	71
Season Adjustment Factor	1.02	1.02	1.02	1.02	1.02	1.02	1.02	1.02	1.02	1.02	1.02	1.02
2022 Peak Season Traffic	12	785	313	165	881	49	58	91	23	139	59	72
Annual Growth Rate	2.89%	2.89%	2.89%	2.89%	2.89%	2.89%	2.89%	2.89%	2.89%	2.89%	2.89%	2.89%
2025 Background Traffic	13	855	341	180	960	53	63	99	26	151	64	79
Nove of Margate						3	8	7			2	
2025 Total Traffic	13	855	341	180	960	56	71	106	26	151	66	79

FUTURE TURNING MOVEMENT VOLUME ANALYSIS

Rock Island Road and Margate Boulevard PM Peak Hour

Description	Rock Island Road Northbound			Rock Island Road Southbound			Margate Boulevard Eastbound			Margate Boulevard Westbound		
	Left	Through	Right	Left	Through	Right	Left	Through	Right	Left	Through	Right
Existing Traffic (5/11/2022)	29	832	154	103	828	84	55	36	20	155	133	141
Season Adjustment Factor	1.02	1.02	1.02	1.02	1.02	1.02	1.02	1.02	1.02	1.02	1.02	1.02
2022 Peak Season Traffic	30	849	157	105	845	86	56	37	20	158	136	144
Annual Growth Rate	2.89%	2.89%	2.89%	2.89%	2.89%	2.89%	2.89%	2.89%	2.89%	2.89%	2.89%	2.89%
2025 Background Traffic	32	924	171	114	920	93	61	40	22	172	148	157
Nove of Margate						8	5	4			7	
2025 Total Traffic	32	924	171	114	920	101	66	44	22	172	155	157

FUTURE TURNING MOVEMENT VOLUME ANALYSIS

**SR 7 and Margate Boulevard
AM Peak Hour**

Description	SR 7 Northbound			SR 7 Southbound			Margate Boulevard Eastbound			Margate Boulevard Westbound		
	Left	Through	Right	Left	Through	Right	Left	Through	Right	Left	Through	Right
Existing Traffic (5/11/2022)	34	1,969		5	1,584	92	473		164			
Season Adjustment Factor	1.02	1.02	1.02	1.02	1.02	1.02	1.02	1.02	1.02	1.02	1.02	1.02
2022 Peak Season Traffic	35	2,008	0	5	1,616	94	482	0	167	0	0	0
Annual Growth Rate	2.89%	2.89%	2.89%	2.89%	2.89%	2.89%	2.89%	2.89%	2.89%	2.89%	2.89%	2.89%
2025 Background Traffic	38	2,188	0	6	1,760	102	526	0	182	0	0	0
Nove of Margate						2	7					
2025 Total Traffic	38	2,188	0	6	1,760	104	533	0	182	0	0	0

FUTURE TURNING MOVEMENT VOLUME ANALYSIS

**SR 7 and Margate Boulevard
PM Peak Hour**

Description	SR 7 Northbound			SR 7 Southbound			Margate Boulevard Eastbound			Margate Boulevard Westbound		
	Left	Through	Right	Left	Through	Right	Left	Through	Right	Left	Through	Right
Existing Traffic (5/11/2022)	97	1,586		12	1,996	147	190		69			
Season Adjustment Factor	1.02	1.02	1.02	1.02	1.02	1.02	1.02	1.02	1.02	1.02	1.02	1.02
2022 Peak Season Traffic	99	1,618	0	12	2,036	150	194	0	70	0	0	0
Annual Growth Rate	2.89%	2.89%	2.89%	2.89%	2.89%	2.89%	2.89%	2.89%	2.89%	2.89%	2.89%	2.89%
2025 Background Traffic	108	1,762	0	13	2,218	163	211	0	77	0	0	0
Nove of Margate						7	4					
2025 Total Traffic	108	1,762	0	13	2,218	170	215	0	77	0	0	0

FUTURE TURNING MOVEMENT VOLUME ANALYSIS

Atlantic Boulevard and Riverside Road AM Peak Hour

Description	Riverside Road Northbound			Riverside Road Southbound			Atlantic Boulevard Eastbound			Atlantic Boulevard Westbound		
	Left	Through	Right	Left	Through	Right	Left	Through	Right	Left	Through	Right
Existing Traffic (5/11/2022)	20	555	327	311	388	162	91	868	65	183	655	225
Season Adjustment Factor	1.02	1.02	1.02	1.02	1.02	1.02	1.02	1.02	1.02	1.02	1.02	1.02
2022 Peak Season Traffic	20	566	334	317	396	165	93	885	66	187	668	230
Annual Growth Rate	2.89%	2.89%	2.89%	2.89%	2.89%	2.89%	2.89%	2.89%	2.89%	2.89%	2.89%	2.89%
2025 Background Traffic	22	617	363	346	431	180	101	964	72	203	728	250
Nove of Margate			0	0				3		1	8	1
2025 Total Traffic	22	617	363	346	431	180	101	967	72	204	736	251

FUTURE TURNING MOVEMENT VOLUME ANALYSIS

Atlantic Boulevard and Riverside Road PM Peak Hour

Description	Riverside Road Northbound			Riverside Road Southbound			Atlantic Boulevard Eastbound			Atlantic Boulevard Westbound		
	Left	Through	Right	Left	Through	Right	Left	Through	Right	Left	Through	Right
Existing Traffic (5/11/2022)	54	630	222	288	465	168	146	901	60	230	853	304
Season Adjustment Factor	1.02	1.02	1.02	1.02	1.02	1.02	1.02	1.02	1.02	1.02	1.02	1.02
2022 Peak Season Traffic	55	643	226	294	474	171	149	919	61	235	870	310
Annual Growth Rate	2.89%	2.89%	2.89%	2.89%	2.89%	2.89%	2.89%	2.89%	2.89%	2.89%	2.89%	2.89%
2025 Background Traffic	60	700	247	320	517	187	162	1,001	67	256	948	338
Nove of Margate			1	1				8		0	4	1
2025 Total Traffic	60	700	248	321	517	187	162	1,009	67	256	952	339

FUTURE TURNING MOVEMENT VOLUME ANALYSIS

Atlantic Boulevard and Ramblewood Drive AM Peak Hour

Description	Ramblewood Drive Northbound			Ramblewood Drive Southbound			Atlantic Boulevard Eastbound			Atlantic Boulevard Westbound		
	Left	Through	Right	Left	Through	Right	Left	Through	Right	Left	Through	Right
Existing Traffic (5/11/2022)	29	20	57	168	10	57	53	1,399	14	26	981	102
Season Adjustment Factor	1.02	1.02	1.02	1.02	1.02	1.02	1.02	1.02	1.02	1.02	1.02	1.02
2022 Peak Season Traffic	30	20	58	171	10	58	54	1,427	14	27	1,001	104
Annual Growth Rate	2.89%	2.89%	2.89%	2.89%	2.89%	2.89%	2.89%	2.89%	2.89%	2.89%	2.89%	2.89%
2025 Background Traffic	32	22	63	187	11	63	59	1,554	16	29	1,090	113
Nove of Margate				0				3			10	1
2025 Total Traffic	32	22	63	187	11	63	59	1,557	16	29	1,100	114

FUTURE TURNING MOVEMENT VOLUME ANALYSIS

Atlantic Boulevard and Ramblewood Drive PM Peak Hour

Description	Ramblewood Drive Northbound			Ramblewood Drive Southbound			Atlantic Boulevard Eastbound			Atlantic Boulevard Westbound		
	Left	Through	Right	Left	Through	Right	Left	Through	Right	Left	Through	Right
Existing Traffic (5/11/2022)	20	8	22	106	15	51	46	1,323	34	89	1,554	144
Season Adjustment Factor	1.02	1.02	1.02	1.02	1.02	1.02	1.02	1.02	1.02	1.02	1.02	1.02
2022 Peak Season Traffic	20	8	22	108	15	52	47	1,349	35	91	1,585	147
Annual Growth Rate	2.89%	2.89%	2.89%	2.89%	2.89%	2.89%	2.89%	2.89%	2.89%	2.89%	2.89%	2.89%
2025 Background Traffic	22	9	24	118	17	57	51	1,470	38	99	1,727	160
Nove of Margate				0				10			5	0
2025 Total Traffic	22	9	24	118	17	57	51	1,480	38	99	1,732	160

FUTURE TURNING MOVEMENT VOLUME ANALYSIS

Atlantic Boulevard and NW 76 Avenue AM Peak Hour

Description	NW 76 Avenue Northbound			NW 76 Avenue Southbound			Atlantic Boulevard Eastbound			Atlantic Boulevard Westbound		
	Left	Through	Right	Left	Through	Right	Left	Through	Right	Left	Through	Right
Existing Traffic (5/11/2022)	31	12	17	77	22	141	55	1,635	50	5	897	52
Season Adjustment Factor	1.02	1.02	1.02	1.02	1.02	1.02	1.02	1.02	1.02	1.02	1.02	1.02
2022 Peak Season Traffic	32	12	17	79	22	144	56	1,668	51	5	915	53
Annual Growth Rate	2.89%	2.89%	2.89%	2.89%	2.89%	2.89%	2.89%	2.89%	2.89%	2.89%	2.89%	2.89%
2025 Background Traffic	34	13	19	86	24	157	61	1,817	56	6	997	58
Nove of Margate				23		11	3					7
2025 Total Traffic	34	13	19	109	24	168	64	1,817	56	6	997	65

FUTURE TURNING MOVEMENT VOLUME ANALYSIS

Atlantic Boulevard and NW 76 Avenue PM Peak Hour

Description	NW 76 Avenue Northbound			NW 76 Avenue Southbound			Atlantic Boulevard Eastbound			Atlantic Boulevard Westbound		
	Left	Through	Right	Left	Through	Right	Left	Through	Right	Left	Through	Right
Existing Traffic (5/11/2022)	30	9	12	60	6	133	112	1,370	35	6	1,696	103
Season Adjustment Factor	1.02	1.02	1.02	1.02	1.02	1.02	1.02	1.02	1.02	1.02	1.02	1.02
2022 Peak Season Traffic	31	9	12	61	6	136	114	1,397	36	6	1,730	105
Annual Growth Rate	2.89%	2.89%	2.89%	2.89%	2.89%	2.89%	2.89%	2.89%	2.89%	2.89%	2.89%	2.89%
2025 Background Traffic	33	10	13	67	7	148	124	1,522	39	7	1,884	114
Nove of Margate				14		5	10					24
2025 Total Traffic	33	10	13	81	7	153	134	1,522	39	7	1,884	138

FUTURE TURNING MOVEMENT VOLUME ANALYSIS

Atlantic Boulevard and Rock Island Road AM Peak Hour

Description	Rock Island Road Northbound			Rock Island Road Southbound			Atlantic Boulevard Eastbound			Atlantic Boulevard Westbound		
	Left	Through	Right	Left	Through	Right	Left	Through	Right	Left	Through	Right
Existing Traffic (5/11/2022)	253	831	423	166	780	104	131	1,167	247	249	642	78
Season Adjustment Factor	1.02	1.02	1.02	1.02	1.02	1.02	1.02	1.02	1.02	1.02	1.02	1.02
2022 Peak Season Traffic	258	848	431	169	796	106	134	1,190	252	254	655	80
Annual Growth Rate	2.89%	2.89%	2.89%	2.89%	2.89%	2.89%	2.89%	2.89%	2.89%	2.89%	2.89%	2.89%
2025 Background Traffic	281	923	470	184	867	116	146	1,297	274	277	713	87
Nove of Margate	1							17	6		6	
2025 Total Traffic	282	923	470	184	867	116	146	1,314	280	277	719	87

FUTURE TURNING MOVEMENT VOLUME ANALYSIS

Atlantic Boulevard and Rock Island Road PM Peak Hour

Description	Rock Island Road Northbound			Rock Island Road Southbound			Atlantic Boulevard Eastbound			Atlantic Boulevard Westbound		
	Left	Through	Right	Left	Through	Right	Left	Through	Right	Left	Through	Right
Existing Traffic (5/11/2022)	344	706	293	134	740	125	206	920	266	472	1,367	131
Season Adjustment Factor	1.02	1.02	1.02	1.02	1.02	1.02	1.02	1.02	1.02	1.02	1.02	1.02
2022 Peak Season Traffic	351	720	299	137	755	128	210	938	271	481	1,394	134
Annual Growth Rate	2.89%	2.89%	2.89%	2.89%	2.89%	2.89%	2.89%	2.89%	2.89%	2.89%	2.89%	2.89%
2025 Background Traffic	382	784	326	149	822	139	229	1,022	296	524	1,519	146
Nove of Margate	6							10	4		18	
2025 Total Traffic	388	784	326	149	822	139	229	1,032	300	524	1,537	146

FUTURE TURNING MOVEMENT VOLUME ANALYSIS

Atlantic Boulevard and SR 7 AM Peak Hour

Description	SR 7 Northbound			SR 7 Southbound			Atlantic Boulevard Eastbound			Atlantic Boulevard Westbound		
	Left	Through	Right	Left	Through	Right	Left	Through	Right	Left	Through	Right
Existing Traffic (5/11/2022)	107	1,466	488	245	1,159	142	427	1,253	169	266	706	156
Season Adjustment Factor	1.02	1.02	1.02	1.02	1.02	1.02	1.02	1.02	1.02	1.02	1.02	1.02
2022 Peak Season Traffic	109	1,495	498	250	1,182	145	436	1,278	172	271	720	159
Annual Growth Rate	2.89%	2.89%	2.89%	2.89%	2.89%	2.89%	2.89%	2.89%	2.89%	2.89%	2.89%	2.89%
2025 Background Traffic	119	1,629	542	272	1,288	158	474	1,392	188	296	784	173
Nove of Margate	3							10	7		3	
2025 Total Traffic	122	1,629	542	272	1,288	158	474	1,402	195	296	787	173

FUTURE TURNING MOVEMENT VOLUME ANALYSIS

Atlantic Boulevard and SR 7 PM Peak Hour

Description	SR 7 Northbound			SR 7 Southbound			Atlantic Boulevard Eastbound			Atlantic Boulevard Westbound		
	Left	Through	Right	Left	Through	Right	Left	Through	Right	Left	Through	Right
Existing Traffic (5/11/2022)	202	1,186	433	120	1,236	191	318	919	244	604	1,456	117
Season Adjustment Factor	1.02	1.02	1.02	1.02	1.02	1.02	1.02	1.02	1.02	1.02	1.02	1.02
2022 Peak Season Traffic	206	1,210	442	122	1,261	195	324	937	249	616	1,485	119
Annual Growth Rate	2.89%	2.89%	2.89%	2.89%	2.89%	2.89%	2.89%	2.89%	2.89%	2.89%	2.89%	2.89%
2025 Background Traffic	224	1,318	481	133	1,373	212	353	1,021	271	671	1,618	130
Nove of Margate	8							6	4		10	
2025 Total Traffic	232	1,318	481	133	1,373	212	353	1,027	275	671	1,628	130

FUTURE TURNING MOVEMENT VOLUME ANALYSIS

SW 71 Avenue/Rock Island Road and Southgate Boulevard AM Peak Hour

Description	SW 71 Avenue Northbound			SW 71 Avenue Southbound			Southgate Boulevard Eastbound			Southgate Boulevard Westbound		
	Left	Through	Right	Left	Through	Right	Left	Through	Right	Left	Through	Right
Existing Traffic (5/11/2022)	152	864	101	257	776	395	498	648	150	34	435	262
Season Adjustment Factor	1.02	1.02	1.02	1.02	1.02	1.02	1.02	1.02	1.02	1.02	1.02	1.02
2022 Peak Season Traffic	155	881	103	262	792	403	508	661	153	35	444	267
Annual Growth Rate	2.89%	2.89%	2.89%	2.89%	2.89%	2.89%	2.89%	2.89%	2.89%	2.89%	2.89%	2.89%
2025 Background Traffic	169	960	112	286	862	439	553	720	167	38	483	291
Nove of Margate		1		2	2	2	0					0
2025 Total Traffic	169	961	112	288	864	441	553	720	167	38	483	291

FUTURE TURNING MOVEMENT VOLUME ANALYSIS

SW 71 Avenue/Rock Island Road and Southgate Boulevard PM Peak Hour

Description	SW 71 Avenue Northbound			SW 71 Avenue Southbound			Southgate Boulevard Eastbound			Southgate Boulevard Westbound		
	Left	Through	Right	Left	Through	Right	Left	Through	Right	Left	Through	Right
Existing Traffic (5/11/2022)	192	842	97	164	949	488	343	405	159	98	513	194
Season Adjustment Factor	1.02	1.02	1.02	1.02	1.02	1.02	1.02	1.02	1.02	1.02	1.02	1.02
2022 Peak Season Traffic	196	859	99	167	968	498	350	413	162	100	523	198
Annual Growth Rate	2.89%	2.89%	2.89%	2.89%	2.89%	2.89%	2.89%	2.89%	2.89%	2.89%	2.89%	2.89%
2025 Background Traffic	213	935	108	182	1,054	542	381	450	177	109	570	216
Nove of Margate		2		0	2	2	2					2
2025 Total Traffic	213	937	108	182	1,056	544	383	450	177	109	570	218

FUTURE TURNING MOVEMENT VOLUME ANALYSIS

Atlantic Boulevard and NW 66 Avenue AM Peak Hour

Description	NW 66 Avenue Northbound			NW 66 Avenue Southbound			Atlantic Boulevard Eastbound			Atlantic Boulevard Westbound		
	Left	Through	Right	Left	Through	Right	Left	Through	Right	Left	Through	Right
Existing Traffic (4/26/2023)	62	22	42	118	18	97	138	1,673	29	16	777	76
Season Adjustment Factor	1.01	1.01	1.01	1.01	1.01	1.01	1.01	1.01	1.01	1.01	1.01	1.01
2023 Peak Season Traffic	63	22	42	119	18	98	139	1,690	29	16	785	77
Annual Growth Rate	2.89%	2.89%	2.89%	2.89%	2.89%	2.89%	2.89%	2.89%	2.89%	2.89%	2.89%	2.89%
2025 Background Traffic	66	24	45	126	19	104	148	1,789	31	17	831	81
Nove of Margate								17			6	
2025 Total Traffic	66	24	45	126	19	104	148	1,806	31	17	837	81

FUTURE TURNING MOVEMENT VOLUME ANALYSIS

Atlantic Boulevard and NW 66 Avenue PM Peak Hour

Description	NW 66 Avenue Northbound			NW 66 Avenue Southbound			Atlantic Boulevard Eastbound			Atlantic Boulevard Westbound		
	Left	Through	Right	Left	Through	Right	Left	Through	Right	Left	Through	Right
Existing Traffic (4/26/2023)	63	15	41	127	27	125	124	1,194	55	58	1,897	146
Season Adjustment Factor	1.01	1.01	1.01	1.01	1.01	1.01	1.01	1.01	1.01	1.01	1.01	1.01
2023 Peak Season Traffic	64	15	41	128	27	126	125	1,206	56	59	1,916	147
Annual Growth Rate	2.89%	2.89%	2.89%	2.89%	2.89%	2.89%	2.89%	2.89%	2.89%	2.89%	2.89%	2.89%
2025 Background Traffic	67	16	44	136	29	134	133	1,277	59	62	2,028	156
Nove of Margate								10			18	
2025 Total Traffic	67	16	44	136	29	134	133	1,287	59	62	2,046	156

FUTURE TURNING MOVEMENT VOLUME ANALYSIS

Margate Boulevard and NW 66 Avenue AM Peak Hour

Description	NW 66 Avenue Northbound			NW 66 Avenue Southbound			Margate Boulevard Eastbound			Margate Boulevard Westbound		
	Left	Through	Right	Left	Through	Right	Left	Through	Right	Left	Through	Right
Existing Traffic (4/26/2023)	35	52	60	41	68	60	87	461	56	22	124	17
Season Adjustment Factor	1.01	1.01	1.01	1.01	1.01	1.01	1.01	1.01	1.01	1.01	1.01	1.01
2023 Peak Season Traffic	35	53	61	41	69	61	88	466	57	22	125	17
Annual Growth Rate	2.89%	2.89%	2.89%	2.89%	2.89%	2.89%	2.89%	2.89%	2.89%	2.89%	2.89%	2.89%
2025 Background Traffic	37	56	64	44	73	64	93	493	60	24	133	18
Nove of Margate								7			2	
2025 Total Traffic	37	56	64	44	73	64	93	500	60	24	135	18

FUTURE TURNING MOVEMENT VOLUME ANALYSIS

Margate Boulevard and NW 66 Avenue PM Peak Hour

Description	NW 66 Avenue Northbound			NW 66 Avenue Southbound			Margate Boulevard Eastbound			Margate Boulevard Westbound		
	Left	Through	Right	Left	Through	Right	Left	Through	Right	Left	Through	Right
Existing Traffic (4/26/2023)	60	75	47	12	72	61	47	189	53	41	375	26
Season Adjustment Factor	1.01	1.01	1.01	1.01	1.01	1.01	1.01	1.01	1.01	1.01	1.01	1.01
2023 Peak Season Traffic	61	76	47	12	73	62	47	191	54	41	379	26
Annual Growth Rate	2.89%	2.89%	2.89%	2.89%	2.89%	2.89%	2.89%	2.89%	2.89%	2.89%	2.89%	2.89%
2025 Background Traffic	64	80	50	13	77	65	50	202	57	44	401	28
Nove of Margate								4			7	
2025 Total Traffic	64	80	50	13	77	65	50	206	57	44	408	28

APPENDIX F

SYNCHRO Analyses

Timings

101: Rock Island Road & Royal Palm Boulevard

Lane Group	EBL	EBT	WBL	WBT	NBL	NBT	NBR	SBL	SBT	SBR
Lane Configurations										
Traffic Volume (vph)	150	917	159	764	369	591	229	224	669	168
Future Volume (vph)	150	917	159	764	369	591	229	224	669	168
Turn Type	Prot	NA	Prot	NA	pm+pt	NA	Perm	pm+pt	NA	Perm
Protected Phases	1	6	5	2	7	4		3	8	
Permitted Phases					4		4	8		8
Detector Phase	1	6	5	2	7	4	4	3	8	8
Switch Phase										
Minimum Initial (s)	5.0	10.0	5.0	10.0	4.0	6.0	6.0	4.0	6.0	6.0
Minimum Split (s)	11.5	43.5	11.5	43.5	10.5	43.5	43.5	10.5	42.0	42.0
Total Split (s)	26.0	60.0	26.0	60.0	32.0	46.0	46.0	28.0	42.0	42.0
Total Split (%)	16.3%	37.5%	16.3%	37.5%	20.0%	28.8%	28.8%	17.5%	26.3%	26.3%
Yellow Time (s)	4.5	4.5	4.5	4.5	4.5	4.5	4.5	4.5	4.5	4.5
All-Red Time (s)	2.0	2.0	2.0	2.0	2.0	2.0	2.0	2.0	2.0	2.0
Lost Time Adjust (s)	0.0	0.0	0.0	0.0	0.0	0.0	0.0	0.0	0.0	0.0
Total Lost Time (s)	6.5	6.5	6.5	6.5	6.5	6.5	6.5	6.5	6.5	6.5
Lead/Lag	Lead	Lag	Lead	Lag	Lead	Lag	Lag	Lead	Lag	Lag
Lead-Lag Optimize?	Yes	Yes	Yes	Yes	Yes	Yes	Yes	Yes	Yes	Yes
Recall Mode	None	C-Max	None	C-Max	None	None	None	None	None	None
Act Effct Green (s)	17.3	55.8	17.8	56.3	65.9	42.1	42.1	53.2	34.9	34.9
Actuated g/C Ratio	0.11	0.35	0.11	0.35	0.41	0.26	0.26	0.33	0.22	0.22
v/c Ratio	0.85	1.16	0.88	0.85	1.23	0.69	0.47	0.80	0.94	0.43
Control Delay	105.0	124.9	108.2	55.1	171.9	79.7	40.6	52.5	82.3	24.1
Queue Delay	0.0	0.0	0.0	0.0	0.0	0.0	0.0	0.0	0.0	0.0
Total Delay	105.0	124.9	108.2	55.1	171.9	79.7	40.6	52.5	82.3	24.1
LOS	F	F	F	E	F	E	D	D	F	C
Approach Delay		122.8		62.7		100.8			66.8	
Approach LOS		F		E		F			E	

Intersection Summary

Cycle Length: 160

Actuated Cycle Length: 160

Offset: 49 (31%), Referenced to phase 2:WBT and 6:EBT, Start of Yellow

Natural Cycle: 150

Control Type: Actuated-Coordinated

Maximum v/c Ratio: 1.23

Intersection Signal Delay: 91.1

Intersection LOS: F

Intersection Capacity Utilization 107.0%

ICU Level of Service G

Analysis Period (min) 15

Splits and Phases: 101: Rock Island Road & Royal Palm Boulevard

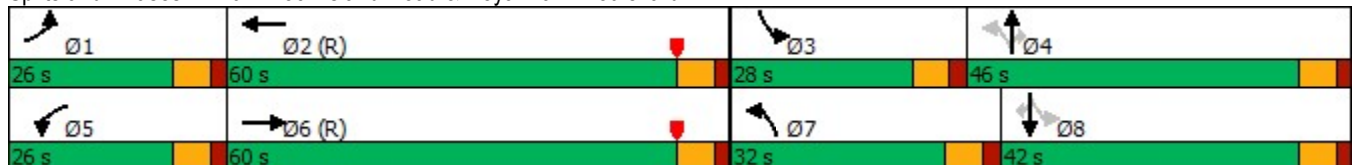

Queues

101: Rock Island Road & Royal Palm Boulevard



Lane Group	EBL	EBT	WBL	WBT	NBL	NBT	NBR	SBL	SBT	SBR
Lane Group Flow (vph)	163	1398	173	1033	401	642	249	243	727	183
v/c Ratio	0.85	1.16	0.88	0.85	1.23	0.69	0.47	0.80	0.94	0.43
Control Delay	105.0	124.9	108.2	55.1	171.9	79.7	40.6	52.5	82.3	24.1
Queue Delay	0.0	0.0	0.0	0.0	0.0	0.0	0.0	0.0	0.0	0.0
Total Delay	105.0	124.9	108.2	55.1	171.9	79.7	40.6	52.5	82.3	24.1
Queue Length 50th (ft)	168	~921	179	529	~469	347	122	169	396	61
Queue Length 95th (ft)	#280	#1063	#304	628	#673	431	219	243	#513	141
Internal Link Dist (ft)		625		856		3088			735	
Turn Bay Length (ft)	300		200		200		160	140		170
Base Capacity (vph)	215	1207	215	1219	327	930	530	339	785	432
Starvation Cap Reductn	0	0	0	0	0	0	0	0	0	0
Spillback Cap Reductn	0	0	0	0	0	0	0	0	0	0
Storage Cap Reductn	0	0	0	0	0	0	0	0	0	0
Reduced v/c Ratio	0.76	1.16	0.80	0.85	1.23	0.69	0.47	0.72	0.93	0.42

Intersection Summary

~ Volume exceeds capacity, queue is theoretically infinite.

Queue shown is maximum after two cycles.

95th percentile volume exceeds capacity, queue may be longer.

Queue shown is maximum after two cycles.

HCM 6th Signalized Intersection Summary

101: Rock Island Road & Royal Palm Boulevard

Movement	EBL	EBT	EBR	WBL	WBT	WBR	NBL	NBT	NBR	SBL	SBT	SBR
Lane Configurations												
Traffic Volume (veh/h)	150	917	369	159	764	187	369	591	229	224	669	168
Future Volume (veh/h)	150	917	369	159	764	187	369	591	229	224	669	168
Initial Q (Qb), veh	0	0	0	0	0	0	0	0	0	0	0	0
Ped-Bike Adj(A_pbT)	1.00		1.00	1.00		0.99	1.00		0.99	1.00		0.98
Parking Bus, Adj	1.00	1.00	1.00	1.00	1.00	1.00	1.00	1.00	1.00	1.00	1.00	1.00
Work Zone On Approach		No			No			No			No	
Adj Sat Flow, veh/h/ln	1870	1870	1870	1870	1870	1870	1870	1870	1870	1870	1870	1870
Adj Flow Rate, veh/h	163	997	401	173	830	203	401	642	249	243	727	183
Peak Hour Factor	0.92	0.92	0.92	0.92	0.92	0.92	0.92	0.92	0.92	0.92	0.92	0.92
Percent Heavy Veh, %	2	2	2	2	2	2	2	2	2	2	2	2
Cap, veh/h	183	875	347	193	1010	247	339	921	405	325	773	339
Arrive On Green	0.14	0.47	0.47	0.14	0.48	0.48	0.27	0.43	0.43	0.12	0.22	0.22
Sat Flow, veh/h	1781	2484	986	1781	2822	690	1781	3554	1562	1781	3554	1559
Grp Volume(v), veh/h	163	710	688	173	522	511	401	642	249	243	727	183
Grp Sat Flow(s),veh/h/ln	1781	1777	1693	1781	1777	1736	1781	1777	1562	1781	1777	1559
Q Serve(g_s), s	14.4	56.4	56.4	15.3	40.5	40.5	25.5	23.5	19.7	16.8	32.2	16.6
Cycle Q Clear(g_c), s	14.4	56.4	56.4	15.3	40.5	40.5	25.5	23.5	19.7	16.8	32.2	16.6
Prop In Lane	1.00		0.58	1.00		0.40	1.00		1.00	1.00		1.00
Lane Grp Cap(c), veh/h	183	626	597	193	636	621	339	921	405	325	773	339
V/C Ratio(X)	0.89	1.13	1.15	0.90	0.82	0.82	1.18	0.70	0.62	0.75	0.94	0.54
Avail Cap(c_a), veh/h	217	626	597	217	636	621	339	921	405	354	788	346
HCM Platoon Ratio	1.33	1.33	1.33	1.33	1.33	1.33	1.67	1.67	1.67	1.00	1.00	1.00
Upstream Filter(l)	1.00	1.00	1.00	1.00	1.00	1.00	0.94	0.94	0.94	1.00	1.00	1.00
Uniform Delay (d), s/veh	68.2	42.5	42.5	67.6	37.5	37.5	40.7	40.3	39.2	42.4	61.6	55.5
Incr Delay (d2), s/veh	27.9	78.6	87.3	30.8	11.4	11.7	107.2	1.9	1.9	6.5	18.5	0.8
Initial Q Delay(d3),s/veh	0.0	0.0	0.0	0.0	0.0	0.0	0.0	0.0	0.0	0.0	0.0	0.0
%ile BackOfQ(50%),veh/ln	7.8	37.0	36.7	8.4	18.7	18.3	20.3	9.6	7.1	8.1	16.6	6.7
Unsig. Movement Delay, s/veh												
LnGrp Delay(d),s/veh	96.1	121.1	129.8	98.5	48.9	49.2	147.9	42.1	41.2	48.9	80.1	56.3
LnGrp LOS	F	F	F	F	D	D	F	D	D	D	F	E
Approach Vol, veh/h		1561			1206			1292			1153	
Approach Delay, s/veh		122.3			56.2			74.8			69.8	
Approach LOS		F			E			E			E	
Timer - Assigned Phs	1	2	3	4	5	6	7	8				
Phs Duration (G+Y+Rc), s	22.9	63.8	25.4	48.0	23.8	62.9	32.0	41.3				
Change Period (Y+Rc), s	6.5	6.5	6.5	6.5	6.5	6.5	6.5	6.5				
Max Green Setting (Gmax), s	19.5	53.5	21.5	39.5	19.5	53.5	25.5	35.5				
Max Q Clear Time (g_c+I1), s	16.4	42.5	18.8	25.5	17.3	58.4	27.5	34.2				
Green Ext Time (p_c), s	0.0	5.1	0.1	3.1	0.0	0.0	0.0	0.6				
Intersection Summary												
HCM 6th Ctrl Delay				83.6								
HCM 6th LOS				F								
Notes												
User approved pedestrian interval to be less than phase max green.												

HCM 6th TWSC
 102: NW 76 Avenue & Margate Boulevard

Intersection						
Int Delay, s/veh	3.5					
Movement	EBT	EBR	WBL	WBT	NBL	NBR
Lane Configurations	↑↑		↖	↑↑	↗	
Traffic Vol, veh/h	90	140	62	52	65	53
Future Vol, veh/h	90	140	62	52	65	53
Conflicting Peds, #/hr	0	2	2	0	3	2
Sign Control	Free	Free	Free	Free	Stop	Stop
RT Channelized	-	None	-	None	-	None
Storage Length	-	-	100	-	0	-
Veh in Median Storage, #	0	-	-	0	1	-
Grade, %	0	-	-	0	0	-
Peak Hour Factor	85	85	85	85	85	85
Heavy Vehicles, %	2	2	2	2	2	2
Mvmt Flow	106	165	73	61	76	62

Major/Minor	Major1	Major2	Minor1	Minor2	Minor3
Conflicting Flow All	0	0	273	0	371
Stage 1	-	-	-	-	191
Stage 2	-	-	-	-	180
Critical Hdwy	-	-	4.14	-	5
Critical Hdwy Stg 1	-	-	-	-	5
Critical Hdwy Stg 2	-	-	-	-	5
Follow-up Hdwy	-	-	2.22	-	3
Pot Cap-1 Maneuver	-	-	1287	-	833
Stage 1	-	-	-	-	996
Stage 2	-	-	-	-	1006
Platoon blocked, %	-	-	-	-	-
Mov Cap-1 Maneuver	-	-	1285	-	781
Mov Cap-2 Maneuver	-	-	-	-	798
Stage 1	-	-	-	-	994
Stage 2	-	-	-	-	946

Approach	EB	WB	NB
HCM Control Delay, s	0	4.3	9.7
HCM LOS			A

Minor Lane/Major Mvmt	NBLn1	EBT	EBR	WBL	WBT
Capacity (veh/h)	899	-	-	1285	-
HCM Lane V/C Ratio	0.154	-	-	0.057	-
HCM Control Delay (s)	9.7	-	-	8	-
HCM Lane LOS	A	-	-	A	-
HCM 95th %tile Q(veh)	0.5	-	-	0.2	-

Timings

103: Rock Island Road & Margate Boulevard



Lane Group	EBL	EBT	WBL	WBT	NBL	NBT	NBR	SBL	SBT	SBR
Lane Configurations										
Traffic Volume (vph)	58	91	139	59	12	785	313	165	881	49
Future Volume (vph)	58	91	139	59	12	785	313	165	881	49
Turn Type	pm+pt	NA	pm+pt	NA	pm+pt	NA	Perm	pm+pt	NA	Perm
Protected Phases	7	4	3	8	5	2		1	6	
Permitted Phases	4		8		2		2	6		6
Detector Phase	7	4	3	8	5	2	2	1	6	6
Switch Phase										
Minimum Initial (s)	4.0	6.0	4.0	6.0	4.0	12.0	12.0	4.0	12.0	12.0
Minimum Split (s)	10.0	37.0	10.0	37.0	10.5	37.5	37.5	10.5	37.5	37.5
Total Split (s)	19.0	40.0	19.0	40.0	23.0	78.0	78.0	23.0	78.0	78.0
Total Split (%)	11.9%	25.0%	11.9%	25.0%	14.4%	48.8%	48.8%	14.4%	48.8%	48.8%
Yellow Time (s)	4.0	4.0	4.0	4.0	4.5	4.5	4.5	4.5	4.5	4.5
All-Red Time (s)	2.0	2.0	2.0	2.0	2.0	2.0	2.0	2.0	2.0	2.0
Lost Time Adjust (s)	0.0	0.0	0.0	0.0	0.0	0.0	0.0	0.0	0.0	0.0
Total Lost Time (s)	6.0	6.0	6.0	6.0	6.5	6.5	6.5	6.5	6.5	6.5
Lead/Lag	Lead	Lag	Lead	Lag	Lead	Lag	Lag	Lead	Lag	Lag
Lead-Lag Optimize?	Yes	Yes	Yes	Yes	Yes	Yes	Yes	Yes	Yes	Yes
Recall Mode	None	None	None	None	None	C-Max	C-Max	None	C-Max	C-Max
Act Effct Green (s)	17.9	9.2	25.5	15.1	109.2	104.9	104.9	119.6	115.4	115.4
Actuated g/C Ratio	0.11	0.06	0.16	0.09	0.68	0.66	0.66	0.75	0.72	0.72
v/c Ratio	0.37	0.56	0.70	0.37	0.03	0.36	0.30	0.38	0.36	0.04
Control Delay	62.3	72.1	78.2	34.8	7.3	11.2	4.0	6.1	4.4	0.0
Queue Delay	0.0	0.0	0.0	0.0	0.0	0.0	0.0	0.0	0.0	0.0
Total Delay	62.3	72.1	78.2	34.8	7.3	11.2	4.0	6.1	4.4	0.0
LOS	E	E	E	C	A	B	A	A	A	A
Approach Delay		68.8		57.1		9.1			4.4	
Approach LOS		E		E		A			A	

Intersection Summary

Cycle Length: 160

Actuated Cycle Length: 160

Offset: 90 (56%), Referenced to phase 2:NBTL and 6:SBTL, Start of Yellow

Natural Cycle: 95

Control Type: Actuated-Coordinated

Maximum v/c Ratio: 0.70

Intersection Signal Delay: 16.0

Intersection LOS: B

Intersection Capacity Utilization 69.9%

ICU Level of Service C

Analysis Period (min) 15

Splits and Phases: 103: Rock Island Road & Margate Boulevard

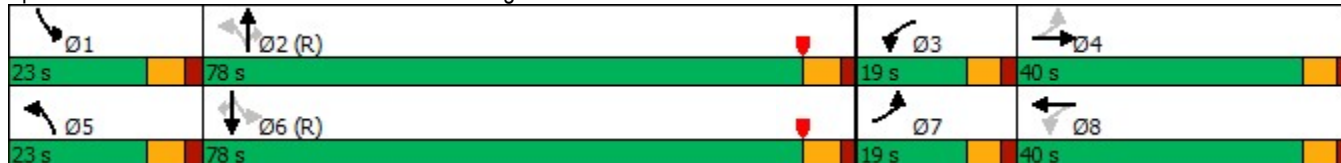

Queues

103: Rock Island Road & Margate Boulevard



Lane Group	EBL	EBT	WBL	WBT	NBL	NBT	NBR	SBL	SBT	SBR
Lane Group Flow (vph)	61	120	146	138	13	826	329	174	927	49
v/c Ratio	0.37	0.56	0.70	0.37	0.03	0.36	0.30	0.38	0.36	0.04
Control Delay	62.3	72.1	78.2	34.8	7.3	11.2	4.0	6.1	4.4	0.0
Queue Delay	0.0	0.0	0.0	0.0	0.0	0.0	0.0	0.0	0.0	0.0
Total Delay	62.3	72.1	78.2	34.8	7.3	11.2	4.0	6.1	4.4	0.0
Queue Length 50th (ft)	55	55	139	32	2	116	4	23	65	0
Queue Length 95th (ft)	100	91	#211	70	m6	202	m82	m36	97	m0
Internal Link Dist (ft)		2155		508		3616			3088	
Turn Bay Length (ft)	320		110		180		180	190		160
Base Capacity (vph)	214	741	211	749	533	2320	1107	525	2553	1171
Starvation Cap Reductn	0	0	0	0	0	0	0	0	0	0
Spillback Cap Reductn	0	0	0	0	0	0	0	0	0	0
Storage Cap Reductn	0	0	0	0	0	0	0	0	0	0
Reduced v/c Ratio	0.29	0.16	0.69	0.18	0.02	0.36	0.30	0.33	0.36	0.04

Intersection Summary























95th percentile volume exceeds capacity, queue may be longer.

Queue shown is maximum after two cycles.

m Volume for 95th percentile queue is metered by upstream signal.

HCM 6th Signalized Intersection Summary

103: Rock Island Road & Margate Boulevard

												
Movement	EBL	EBT	EBR	WBL	WBT	WBR	NBL	NBT	NBR	SBL	SBT	SBR
Lane Configurations												
Traffic Volume (veh/h)	58	91	23	139	59	72	12	785	313	165	881	49
Future Volume (veh/h)	58	91	23	139	59	72	12	785	313	165	881	49
Initial Q (Qb), veh	0	0	0	0	0	0	0	0	0	0	0	0
Ped-Bike Adj(A_pbT)	0.99		0.99	1.00		0.99	1.00		1.00	1.00		1.00
Parking Bus, Adj	1.00	1.00	1.00	1.00	1.00	1.00	1.00	1.00	1.00	1.00	1.00	1.00
Work Zone On Approach		No			No			No			No	
Adj Sat Flow, veh/h/ln	1870	1870	1870	1870	1870	1870	1870	1870	1870	1870	1870	1870
Adj Flow Rate, veh/h	61	96	24	146	62	76	13	826	329	174	927	49
Peak Hour Factor	0.95	0.95	0.95	0.95	0.95	0.95	0.95	0.95	0.95	0.95	0.95	1.00
Percent Heavy Veh, %	2	2	2	2	2	2	2	2	2	2	2	2
Cap, veh/h	188	175	42	225	180	160	442	2329	1037	424	2452	1092
Arrive On Green	0.04	0.06	0.06	0.08	0.10	0.10	0.01	0.87	0.85	0.06	0.92	0.92
Sat Flow, veh/h	1781	2832	684	1781	1777	1576	1781	3554	1583	1781	3554	1583
Grp Volume(v), veh/h	61	59	61	146	62	76	13	826	329	174	927	49
Grp Sat Flow(s),veh/h/ln	1781	1777	1739	1781	1777	1576	1781	1777	1583	1781	1777	1583
Q Serve(g_s), s	5.1	5.2	5.5	12.1	5.2	7.3	0.4	6.9	6.7	5.2	5.3	0.4
Cycle Q Clear(g_c), s	5.1	5.2	5.5	12.1	5.2	7.3	0.4	6.9	6.7	5.2	5.3	0.4
Prop In Lane	1.00		0.39	1.00		1.00	1.00		1.00	1.00		1.00
Lane Grp Cap(c), veh/h	188	110	107	225	180	160	442	2329	1037	424	2452	1092
V/C Ratio(X)	0.32	0.54	0.57	0.65	0.34	0.48	0.03	0.35	0.32	0.41	0.38	0.04
Avail Cap(c_a), veh/h	259	378	370	225	378	335	606	2329	1037	527	2452	1092
HCM Platoon Ratio	1.00	1.00	1.00	1.00	1.00	1.00	1.33	1.33	1.30	1.33	1.33	1.33
Upstream Filter(l)	1.00	1.00	1.00	1.00	1.00	1.00	0.52	0.52	0.52	0.37	0.37	0.37
Uniform Delay (d), s/veh	66.6	72.9	73.0	62.4	66.9	67.9	8.9	4.0	4.6	7.8	2.3	2.1
Incr Delay (d2), s/veh	0.4	1.5	1.8	5.1	0.4	0.8	0.0	0.2	0.4	0.1	0.2	0.0
Initial Q Delay(d3),s/veh	0.0	0.0	0.0	0.0	0.0	0.0	0.0	0.0	0.0	0.0	0.0	0.0
%ile BackOfQ(50%),veh/ln	2.4	2.4	2.5	5.8	2.4	3.0	0.2	2.2	2.0	1.9	1.5	0.2
Unsig. Movement Delay, s/veh												
LnGrp Delay(d),s/veh	67.0	74.4	74.8	67.5	67.3	68.7	8.9	4.2	5.0	7.9	2.4	2.1
LnGrp LOS	E	E	E	E	E	E	A	A	A	A	A	A
Approach Vol, veh/h		181			284			1168			1150	
Approach Delay, s/veh		72.0			67.8			4.5			3.2	
Approach LOS		E			E			A			A	
Timer - Assigned Phs	1	2	3	4	5	6	7	8				
Phs Duration (G+Y+Rc), s	13.8	111.4	19.0	15.9	8.3	116.9	12.6	22.2				
Change Period (Y+Rc), s	6.5	6.5	6.0	6.0	6.5	6.5	6.0	6.0				
Max Green Setting (Gmax), s	16.5	71.5	13.0	34.0	16.5	71.5	13.0	34.0				
Max Q Clear Time (g_c+I1), s	7.2	8.9	14.1	7.5	2.4	7.3	7.1	9.3				
Green Ext Time (p_c), s	0.1	9.0	0.0	0.4	0.0	8.8	0.0	0.5				
Intersection Summary												
HCM 6th Ctrl Delay				14.8								
HCM 6th LOS				B								

Timings

104: SR 7 & Margate Boulevard



Lane Group	EBL	EBR	NBL	NBT	SBL	SBT	Ø3
Lane Configurations	↖↗	↗	↖	↑↑↑	↖	↑↑↑	
Traffic Volume (vph)	482	167	35	2008	5	1616	
Future Volume (vph)	482	167	35	2008	5	1616	
Turn Type	Prot	Perm	Prot	NA	Prot	NA	
Protected Phases	4		5	2	1	6	3
Permitted Phases		4					
Detector Phase	4	4	5	2	1	6	
Switch Phase							
Minimum Initial (s)	7.0	7.0	4.0	12.0	4.0	12.0	5.0
Minimum Split (s)	44.5	44.5	11.5	43.0	10.0	44.5	19.0
Total Split (s)	45.0	45.0	15.0	81.0	15.0	81.0	19.0
Total Split (%)	28.1%	28.1%	9.4%	50.6%	9.4%	50.6%	12%
Yellow Time (s)	4.0	4.0	4.0	4.0	4.0	4.0	4.0
All-Red Time (s)	2.5	2.5	2.0	2.0	2.0	2.0	2.5
Lost Time Adjust (s)	0.0	0.0	0.0	0.0	0.0	0.0	
Total Lost Time (s)	6.5	6.5	6.0	6.0	6.0	6.0	
Lead/Lag	Lag	Lag	Lead	Lag	Lead	Lag	Lead
Lead-Lag Optimize?	Yes	Yes	Yes	Yes	Yes	Yes	Yes
Recall Mode	None	None	None	C-Max	None	C-Max	None
Act Effct Green (s)	27.4	27.4	7.2	117.8	4.6	108.9	
Actuated g/C Ratio	0.17	0.17	0.04	0.74	0.03	0.68	
v/c Ratio	0.84	0.42	0.46	0.55	0.10	0.51	
Control Delay	77.2	10.1	56.0	23.5	79.2	14.1	
Queue Delay	0.0	0.0	0.0	0.0	0.0	0.0	
Total Delay	77.2	10.1	56.0	23.5	79.2	14.1	
LOS	E	B	E	C	E	B	
Approach Delay				24.1		14.3	
Approach LOS				C		B	

Intersection Summary

Cycle Length: 160
 Actuated Cycle Length: 160
 Offset: 138 (86%), Referenced to phase 2:NBT and 6:SBT, Start of Yellow
 Natural Cycle: 130
 Control Type: Actuated-Coordinated
 Maximum v/c Ratio: 0.84
 Intersection Signal Delay: 25.6
 Intersection Capacity Utilization 60.9%
 Analysis Period (min) 15
 Intersection LOS: C
 ICU Level of Service B

Splits and Phases: 104: SR 7 & Margate Boulevard



Queues

104: SR 7 & Margate Boulevard





























Lane Group	EBL	EBR	NBL	NBT	SBL	SBT
Lane Group Flow (vph)	492	170	36	2049	5	1745
v/c Ratio	0.84	0.42	0.46	0.55	0.10	0.51
Control Delay	77.2	10.1	56.0	23.5	79.2	14.1
Queue Delay	0.0	0.0	0.0	0.0	0.0	0.0
Total Delay	77.2	10.1	56.0	23.5	79.2	14.1
Queue Length 50th (ft)	260	0	36	515	5	319
Queue Length 95th (ft)	312	66	m38	m583	21	423
Internal Link Dist (ft)				2153		276
Turn Bay Length (ft)	120	120	250		200	
Base Capacity (vph)	826	504	102	3743	99	3432
Starvation Cap Reductn	0	0	0	0	0	0
Spillback Cap Reductn	0	0	0	0	0	0
Storage Cap Reductn	0	0	0	0	0	0
Reduced v/c Ratio	0.60	0.34	0.35	0.55	0.05	0.51

Intersection Summary

m Volume for 95th percentile queue is metered by upstream signal.

HCM Signalized Intersection Capacity Analysis

104: SR 7 & Margate Boulevard

												
Movement	EBL	EBT	EBR	WBL	WBT	WBR	NBL	NBT	NBR	SBL	SBT	SBR
Lane Configurations	 				 			  			  	
Traffic Volume (vph)	482	0	167	0	0	0	35	2008	0	5	1616	94
Future Volume (vph)	482	0	167	0	0	0	35	2008	0	5	1616	94
Ideal Flow (vphpl)	1900	1900	1900	1900	1900	1900	1900	1900	1900	1900	1900	1900
Total Lost time (s)	6.5		6.5				6.0	6.0		6.0	6.0	
Lane Util. Factor	0.97		1.00				1.00	0.91		1.00	0.91	
Frbp, ped/bikes	1.00		0.99				1.00	1.00		1.00	1.00	
Flpb, ped/bikes	1.00		1.00				1.00	1.00		1.00	1.00	
Frt	1.00		0.85				1.00	1.00		1.00	0.99	
Flt Protected	0.95		1.00				0.95	1.00		0.95	1.00	
Satd. Flow (prot)	3433		1562				1770	5085		1770	5037	
Flt Permitted	0.95		1.00				0.95	1.00		0.95	1.00	
Satd. Flow (perm)	3433		1562				1770	5085		1770	5037	
Peak-hour factor, PHF	0.98	0.98	0.98	0.98	0.98	0.98	0.98	0.98	0.98	0.98	0.98	0.98
Adj. Flow (vph)	492	0	170	0	0	0	36	2049	0	5	1649	96
RTOR Reduction (vph)	0	0	141	0	0	0	0	0	0	0	2	0
Lane Group Flow (vph)	492	0	29	0	0	0	36	2049	0	5	1743	0
Confl. Peds. (#/hr)			1	1			1					1
Turn Type	Prot		Perm				Prot	NA	Perm	Prot	NA	
Protected Phases	4				3		5	2		1	6	
Permitted Phases			4	3					2			
Actuated Green, G (s)	27.4		27.4				6.4	113.0		1.1	107.7	
Effective Green, g (s)	27.4		27.4				6.4	113.0		1.1	107.7	
Actuated g/C Ratio	0.17		0.17				0.04	0.71		0.01	0.67	
Clearance Time (s)	6.5		6.5				6.0	6.0		6.0	6.0	
Vehicle Extension (s)	2.0		2.0				1.5	3.0		1.5	3.0	
Lane Grp Cap (vph)	587		267				70	3591		12	3390	
v/s Ratio Prot	c0.14						c0.02	c0.40		0.00	0.35	
v/s Ratio Perm			0.02									
v/c Ratio	0.84		0.11				0.51	0.57		0.42	0.51	
Uniform Delay, d1	64.2		56.0				75.3	11.6		79.1	13.1	
Progression Factor	1.00		1.00				0.67	2.25		1.00	1.00	
Incremental Delay, d2	9.7		0.1				0.9	0.2		8.3	0.6	
Delay (s)	73.9		56.1				51.5	26.3		87.4	13.6	
Level of Service	E		E				D	C		F	B	
Approach Delay (s)		69.3			0.0			26.7			13.8	
Approach LOS		E			A			C			B	
Intersection Summary												
HCM 2000 Control Delay			28.0				HCM 2000 Level of Service			C		
HCM 2000 Volume to Capacity ratio			0.66									
Actuated Cycle Length (s)			160.0				Sum of lost time (s)			25.0		
Intersection Capacity Utilization			60.9%				ICU Level of Service			B		
Analysis Period (min)			15									
c Critical Lane Group												

HCM 6th Signalized Intersection Summary
104: SR 7 & Margate Boulevard

HCM 6th Edition methodology expects strict NEMA phasing.

Timings

105: Riverside Drive & Atlantic Boulevard /Atlantic Boulevard

Lane Group	EBL	EBT	EBR	WBL	WBT	WBR	NBL	NBT	NBR	SBL	SBT	SBR
Lane Configurations												
Traffic Volume (vph)	93	885	66	187	668	230	20	566	334	317	396	165
Future Volume (vph)	93	885	66	187	668	230	20	566	334	317	396	165
Turn Type	Prot	NA	Perm	Prot	NA	Perm	Prot	NA	Perm	Prot	NA	Perm
Protected Phases	1	6		5	2		7	4		3	8	
Permitted Phases			6			2			4			8
Detector Phase	1	6	6	5	2	2	7	4	4	3	8	8
Switch Phase												
Minimum Initial (s)	5.0	12.0	12.0	5.0	12.0	12.0	4.0	6.0	6.0	5.0	6.0	6.0
Minimum Split (s)	11.0	36.0	36.0	24.0	36.0	36.0	10.0	32.0	32.0	11.0	20.0	20.0
Total Split (s)	60.0	50.0	50.0	60.0	50.0	50.0	30.0	32.0	32.0	18.0	20.0	20.0
Total Split (%)	37.5%	31.3%	31.3%	37.5%	31.3%	31.3%	18.8%	20.0%	20.0%	11.3%	12.5%	12.5%
Yellow Time (s)	4.0	5.0	5.0	4.0	5.0	5.0	4.0	5.0	5.0	4.0	5.0	5.0
All-Red Time (s)	2.0	2.0	2.0	2.0	2.0	2.0	2.0	2.0	2.0	2.0	2.0	2.0
Lost Time Adjust (s)	0.0	0.0	0.0	0.0	0.0	0.0	0.0	0.0	0.0	0.0	0.0	0.0
Total Lost Time (s)	6.0	7.0	7.0	6.0	7.0	7.0	6.0	7.0	7.0	6.0	7.0	7.0
Lead/Lag	Lead	Lag	Lag	Lead	Lag	Lag	Lead	Lag	Lag	Lead	Lag	Lag
Lead-Lag Optimize?	Yes	Yes	Yes	Yes	Yes	Yes	Yes	Yes	Yes	Yes	Yes	Yes
Recall Mode	None	C-Max	C-Max	None	C-Max	C-Max	None	None	None	None	None	None
Act Effct Green (s)	8.8	83.3	83.3	13.7	88.2	88.2	5.0	25.0	25.0	12.0	36.0	36.0
Actuated g/C Ratio	0.06	0.52	0.52	0.09	0.55	0.55	0.03	0.16	0.16	0.08	0.22	0.22
v/c Ratio	0.55	0.37	0.08	0.71	0.26	0.26	0.20	1.14	0.66	1.37	0.55	0.37
Control Delay	84.2	23.6	0.2	66.8	19.4	11.6	79.5	141.0	11.6	240.3	59.0	9.0
Queue Delay	0.0	0.0	0.0	0.0	0.0	0.0	0.0	0.0	0.0	0.0	0.0	0.0
Total Delay	84.2	23.6	0.2	66.8	19.4	11.6	79.5	141.0	11.6	240.3	59.0	9.0
LOS	F	C	A	E	B	B	E	F	B	F	E	A
Approach Delay		27.5			25.9			92.7			115.1	
Approach LOS		C			C			F			F	

Intersection Summary

Cycle Length: 160

Actuated Cycle Length: 160

Offset: 0 (0%), Referenced to phase 2:WBT and 6:EBT, Start of Yellow

Natural Cycle: 105

Control Type: Actuated-Coordinated

Maximum v/c Ratio: 1.37

Intersection Signal Delay: 61.9

Intersection LOS: E

Intersection Capacity Utilization 75.9%

ICU Level of Service D





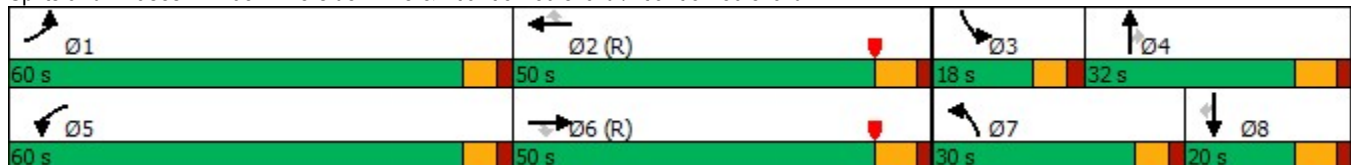







Analysis Period (min) 15

Splits and Phases: 105: Riverside Drive & Atlantic Boulevard /Atlantic Boulevard



Queues

105: Riverside Drive & Atlantic Boulevard /Atlantic Boulevard

												
Lane Group	EBL	EBT	EBR	WBL	WBT	WBR	NBL	NBT	NBR	SBL	SBT	SBR
Lane Group Flow (vph)	103	983	73	208	742	256	22	629	371	352	440	183
v/c Ratio	0.55	0.37	0.08	0.71	0.26	0.26	0.20	1.14	0.66	1.37	0.55	0.37
Control Delay	84.2	23.6	0.2	66.8	19.4	11.6	79.5	141.0	11.6	240.3	59.0	9.0
Queue Delay	0.0	0.0	0.0	0.0	0.0	0.0	0.0	0.0	0.0	0.0	0.0	0.0
Total Delay	84.2	23.6	0.2	66.8	19.4	11.6	79.5	141.0	11.6	240.3	59.0	9.0
Queue Length 50th (ft)	55	219	0	89	255	168	11	~402	0	~249	224	0
Queue Length 95th (ft)	87	269	0	120	289	259	28	#532	103	#356	289	70
Internal Link Dist (ft)		1763			2560			1528			1193	
Turn Bay Length (ft)	250		300	220		270	300		300	300		300
Base Capacity (vph)	1158	2647	883	1158	2803	974	514	552	560	257	797	498
Starvation Cap Reductn	0	0	0	0	0	0	0	0	0	0	0	0
Spillback Cap Reductn	0	0	0	0	0	0	0	0	0	0	0	0
Storage Cap Reductn	0	0	0	0	0	0	0	0	0	0	0	0
Reduced v/c Ratio	0.09	0.37	0.08	0.18	0.26	0.26	0.04	1.14	0.66	1.37	0.55	0.37

Intersection Summary



































~ Volume exceeds capacity, queue is theoretically infinite.

Queue shown is maximum after two cycles.

95th percentile volume exceeds capacity, queue may be longer.

Queue shown is maximum after two cycles.

HCM 6th Signalized Intersection Summary
 105: Riverside Drive & Atlantic Boulevard /Atlantic Boulevard

												
Movement	EBL	EBT	EBR	WBL	WBT	WBR	NBL	NBT	NBR	SBL	SBT	SBR
Lane Configurations	 	  		 	  		 	 		 	 	
Traffic Volume (veh/h)	93	885	66	187	668	230	20	566	334	317	396	165
Future Volume (veh/h)	93	885	66	187	668	230	20	566	334	317	396	165
Initial Q (Qb), veh	0	0	0	0	0	0	0	0	0	0	0	0
Ped-Bike Adj(A_pbT)	1.00		1.00	1.00		1.00	1.00		1.00	1.00		1.00
Parking Bus, Adj	1.00	1.00	1.00	1.00	1.00	1.00	1.00	1.00	1.00	1.00	1.00	1.00
Work Zone On Approach		No			No			No			No	
Adj Sat Flow, veh/h/ln	1870	1870	1870	1870	1870	1870	1870	1870	1870	1870	1870	1870
Adj Flow Rate, veh/h	103	983	73	208	742	256	22	629	371	352	440	183
Peak Hour Factor	0.90	0.90	0.90	0.90	0.90	0.90	0.90	0.90	0.90	0.90	0.90	0.90
Percent Heavy Veh, %	2	2	2	2	2	2	2	2	2	2	2	2
Cap, veh/h	146	2722	844	253	2881	893	54	555	248	259	766	342
Arrive On Green	0.06	0.71	0.71	0.10	0.75	0.75	0.02	0.16	0.16	0.08	0.22	0.22
Sat Flow, veh/h	3456	5106	1583	3456	5106	1583	3456	3554	1585	3456	3554	1585
Grp Volume(v), veh/h	103	983	73	208	742	256	22	629	371	352	440	183
Grp Sat Flow(s),veh/h/ln	1728	1702	1583	1728	1702	1583	1728	1777	1585	1728	1777	1585
Q Serve(g_s), s	4.7	12.0	2.3	9.5	7.2	8.2	1.0	25.0	25.0	12.0	17.7	16.4
Cycle Q Clear(g_c), s	4.7	12.0	2.3	9.5	7.2	8.2	1.0	25.0	25.0	12.0	17.7	16.4
Prop In Lane	1.00		1.00	1.00		1.00	1.00		1.00	1.00		1.00
Lane Grp Cap(c), veh/h	146	2722	844	253	2881	893	54	555	248	259	766	342
V/C Ratio(X)	0.71	0.36	0.09	0.82	0.26	0.29	0.41	1.13	1.50	1.36	0.57	0.54
Avail Cap(c_a), veh/h	1166	2722	844	1166	2881	893	518	555	248	259	766	342
HCM Platoon Ratio	1.33	1.33	1.33	1.33	1.33	1.33	1.00	1.00	1.00	1.00	1.00	1.00
Upstream Filter(I)	1.00	1.00	1.00	0.95	0.95	0.95	1.00	1.00	1.00	1.00	1.00	1.00
Uniform Delay (d), s/veh	74.6	12.6	11.2	71.2	9.6	9.7	78.0	67.5	67.5	74.0	56.2	55.6
Incr Delay (d2), s/veh	2.4	0.4	0.2	2.4	0.2	0.8	1.8	80.3	244.2	184.2	0.7	0.9
Initial Q Delay(d3),s/veh	0.0	0.0	0.0	0.0	0.0	0.0	0.0	0.0	0.0	0.0	0.0	0.0
%ile BackOfQ(50%),veh/ln	2.1	4.2	0.9	4.2	2.6	2.9	0.5	17.6	27.0	12.0	8.1	6.7
Unsig. Movement Delay, s/veh												
LnGrp Delay(d),s/veh	76.9	13.0	11.4	73.6	9.8	10.5	79.9	147.8	311.7	258.2	56.9	56.5
LnGrp LOS	E	B	B	E	A	B	E	F	F	F	E	E
Approach Vol, veh/h		1159			1206			1022			975	
Approach Delay, s/veh		18.6			21.0			205.8			129.5	
Approach LOS		B			C			F			F	
Timer - Assigned Phs	1	2	3	4	5	6	7	8				
Phs Duration (G+Y+Rc), s	12.7	97.3	18.0	32.0	17.7	92.3	8.5	41.5				
Change Period (Y+Rc), s	6.0	7.0	6.0	7.0	6.0	7.0	6.0	7.0				
Max Green Setting (Gmax), s	54.0	43.0	12.0	25.0	54.0	43.0	24.0	13.0				
Max Q Clear Time (g_c+I1), s	6.7	10.2	14.0	27.0	11.5	14.0	3.0	19.7				
Green Ext Time (p_c), s	0.1	7.0	0.0	0.0	0.3	8.4	0.0	0.0				
Intersection Summary												
HCM 6th Ctrl Delay			87.9									
HCM 6th LOS			F									
Notes												
User approved pedestrian interval to be less than phase max green.												

Timings

106: Ramblewood Drive & Atlantic Boulevard



Lane Group	EBL	EBT	WBL	WBT	NBL	NBT	NBR	SBL	SBT	SBR
Lane Configurations										
Traffic Volume (vph)	54	1427	27	1001	30	20	58	171	10	58
Future Volume (vph)	54	1427	27	1001	30	20	58	171	10	58
Turn Type	pm+pt	NA	pm+pt	NA	Perm	NA	Perm	Perm	NA	Perm
Protected Phases	1	6	5	2		4			8	
Permitted Phases	6		2		4		4	8		8
Detector Phase	1	6	5	2	4	4	4	8	8	8
Switch Phase										
Minimum Initial (s)	4.0	12.0	4.0	12.0	6.0	6.0	6.0	6.0	6.0	6.0
Minimum Split (s)	11.0	45.0	11.0	45.0	36.0	36.0	36.0	36.0	36.0	36.0
Total Split (s)	19.0	91.0	19.0	91.0	50.0	50.0	50.0	50.0	50.0	50.0
Total Split (%)	11.9%	56.9%	11.9%	56.9%	31.3%	31.3%	31.3%	31.3%	31.3%	31.3%
Yellow Time (s)	5.0	5.0	5.0	5.0	4.0	4.0	4.0	4.0	4.0	4.0
All-Red Time (s)	2.0	2.0	2.0	2.0	2.0	2.0	2.0	2.0	2.0	2.0
Lost Time Adjust (s)	0.0	0.0	0.0	0.0	0.0	0.0	0.0	0.0	0.0	0.0
Total Lost Time (s)	7.0	7.0	7.0	7.0	6.0	6.0	6.0	6.0	6.0	6.0
Lead/Lag	Lead	Lag	Lead	Lag						
Lead-Lag Optimize?	Yes	Yes	Yes	Yes						
Recall Mode	None	C-Max	None	C-Max	None	None	None	None	None	None
Act Effct Green (s)	114.7	110.0	113.3	109.3	27.4	27.4	27.4	27.4	27.4	27.4
Actuated g/C Ratio	0.72	0.69	0.71	0.68	0.17	0.17	0.17	0.17	0.17	0.17
v/c Ratio	0.20	0.46	0.15	0.36	0.14	0.04	0.19	0.81	0.03	0.19
Control Delay	3.6	4.9	9.4	12.6	54.3	51.5	8.5	87.2	51.2	8.5
Queue Delay	0.0	0.0	0.0	0.0	0.0	0.0	0.0	0.0	0.0	0.0
Total Delay	3.6	4.9	9.4	12.6	54.3	51.5	8.5	87.2	51.2	8.5
LOS	A	A	A	B	D	D	A	F	D	A
Approach Delay		4.8		12.5		29.2			66.7	
Approach LOS		A		B		C			E	

Intersection Summary

Cycle Length: 160

Actuated Cycle Length: 160

Offset: 83 (52%), Referenced to phase 2:WBTL and 6:EBTL, Start of Yellow

Natural Cycle: 95

Control Type: Actuated-Coordinated

Maximum v/c Ratio: 0.81

Intersection Signal Delay: 13.6

Intersection LOS: B

Intersection Capacity Utilization 68.4%

ICU Level of Service C

Analysis Period (min) 15

Splits and Phases: 106: Ramblewood Drive & Atlantic Boulevard

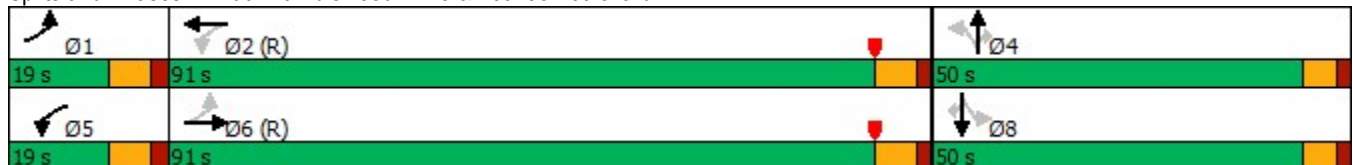

Queues

106: Ramblewood Drive & Atlantic Boulevard

























Lane Group	EBL	EBT	WBL	WBT	NBL	NBT	NBR	SBL	SBT	SBR
Lane Group Flow (vph)	60	1602	30	1228	33	22	64	190	11	64
v/c Ratio	0.20	0.46	0.15	0.36	0.14	0.04	0.19	0.81	0.03	0.19
Control Delay	3.6	4.9	9.4	12.6	54.3	51.5	8.5	87.2	51.2	8.5
Queue Delay	0.0	0.0	0.0	0.0	0.0	0.0	0.0	0.0	0.0	0.0
Total Delay	3.6	4.9	9.4	12.6	54.3	51.5	8.5	87.2	51.2	8.5
Queue Length 50th (ft)	3	43	10	176	30	10	0	194	10	0
Queue Length 95th (ft)	m10	m341	23	193	60	23	32	270	27	32
Internal Link Dist (ft)		2560		3088		436			532	
Turn Bay Length (ft)	180		180		200		425	180		275
Base Capacity (vph)	375	3492	284	3430	383	973	484	380	512	483
Starvation Cap Reductn	0	0	0	0	0	0	0	0	0	0
Spillback Cap Reductn	0	0	0	0	0	0	0	0	0	0
Storage Cap Reductn	0	0	0	0	0	0	0	0	0	0
Reduced v/c Ratio	0.16	0.46	0.11	0.36	0.09	0.02	0.13	0.50	0.02	0.13

Intersection Summary

m Volume for 95th percentile queue is metered by upstream signal.

HCM 6th Signalized Intersection Summary

106: Ramblewood Drive & Atlantic Boulevard

												
Movement	EBL	EBT	EBR	WBL	WBT	WBR	NBL	NBT	NBR	SBL	SBT	SBR
Lane Configurations												
Traffic Volume (veh/h)	54	1427	14	27	1001	104	30	20	58	171	10	58
Future Volume (veh/h)	54	1427	14	27	1001	104	30	20	58	171	10	58
Initial Q (Qb), veh	0	0	0	0	0	0	0	0	0	0	0	0
Ped-Bike Adj(A_pbT)	1.00		0.98	1.00		1.00	1.00		0.98	1.00		1.00
Parking Bus, Adj	1.00	1.00	1.00	1.00	1.00	1.00	1.00	1.00	1.00	1.00	1.00	1.00
Work Zone On Approach		No			No			No			No	
Adj Sat Flow, veh/h/ln	1870	1870	1870	1870	1870	1870	1870	1870	1870	1870	1870	1870
Adj Flow Rate, veh/h	60	1586	16	30	1112	116	33	22	64	190	11	64
Peak Hour Factor	0.90	0.90	0.90	0.90	0.90	0.90	0.90	0.90	0.90	0.90	0.90	0.90
Percent Heavy Veh, %	2	2	2	2	2	2	2	2	2	2	2	2
Cap, veh/h	383	3593	36	283	3216	335	259	594	260	257	313	264
Arrive On Green	0.03	0.92	0.92	0.02	0.91	0.91	0.17	0.17	0.17	0.17	0.17	0.17
Sat Flow, veh/h	1781	5211	53	1781	4697	490	1320	3554	1558	1307	1870	1579
Grp Volume(v), veh/h	60	1036	566	30	806	422	33	22	64	190	11	64
Grp Sat Flow(s),veh/h/ln	1781	1702	1860	1781	1702	1782	1320	1777	1558	1307	1870	1579
Q Serve(g_s), s	1.6	6.8	6.8	0.8	4.9	5.0	3.4	0.8	5.7	22.8	0.8	5.6
Cycle Q Clear(g_c), s	1.6	6.8	6.8	0.8	4.9	5.0	4.2	0.8	5.7	23.6	0.8	5.6
Prop In Lane	1.00		0.03	1.00		0.27	1.00		1.00	1.00		1.00
Lane Grp Cap(c), veh/h	383	2347	1282	283	2331	1220	259	594	260	257	313	264
V/C Ratio(X)	0.16	0.44	0.44	0.11	0.35	0.35	0.13	0.04	0.25	0.74	0.04	0.24
Avail Cap(c_a), veh/h	475	2347	1282	384	2331	1220	402	977	429	398	514	434
HCM Platoon Ratio	1.33	1.33	1.33	1.33	1.33	1.33	1.00	1.00	1.00	1.00	1.00	1.00
Upstream Filter(l)	0.72	0.72	0.72	0.96	0.96	0.96	1.00	1.00	1.00	1.00	1.00	1.00
Uniform Delay (d), s/veh	7.1	2.3	2.3	7.3	2.5	2.5	57.6	55.8	57.9	65.7	55.8	57.8
Incr Delay (d2), s/veh	0.1	0.4	0.8	0.1	0.4	0.7	0.2	0.0	0.5	4.2	0.0	0.5
Initial Q Delay(d3),s/veh	0.0	0.0	0.0	0.0	0.0	0.0	0.0	0.0	0.0	0.0	0.0	0.0
%ile BackOfQ(50%),veh/ln	0.6	1.8	2.1	0.3	1.5	1.7	1.2	0.4	0.0	7.9	0.4	2.3
Unsig. Movement Delay, s/veh												
LnGrp Delay(d),s/veh	7.1	2.8	3.1	7.3	2.9	3.2	57.8	55.9	58.4	69.9	55.9	58.3
LnGrp LOS	A	A	A	A	A	A	E	E	E	E	E	E
Approach Vol, veh/h		1662			1258			119			265	
Approach Delay, s/veh		3.1			3.1			57.8			66.5	
Approach LOS		A			A			E			E	
Timer - Assigned Phs	1	2		4	5	6		8				
Phs Duration (G+Y+Rc), s	10.7	116.5		32.7	9.9	117.3		32.7				
Change Period (Y+Rc), s	7.0	7.0		6.0	7.0	7.0		6.0				
Max Green Setting (Gmax), s	12.0	84.0		44.0	12.0	84.0		44.0				
Max Q Clear Time (g_c+I1), s	3.6	7.0		7.7	2.8	8.8		25.6				
Green Ext Time (p_c), s	0.0	12.0		0.4	0.0	18.9		0.8				
Intersection Summary												
HCM 6th Ctrl Delay				10.1								
HCM 6th LOS				B								

Timings

107: NW 76 Avenue & Atlantic Boulevard



Lane Group	EBL	EBT	WBL	WBT	NBL	NBT	SBL	SBT	SBR
Lane Configurations									
Traffic Volume (vph)	56	1668	5	915	32	12	79	22	144
Future Volume (vph)	56	1668	5	915	32	12	79	22	144
Turn Type	Prot	NA	Prot	NA	Perm	NA	Perm	NA	Perm
Protected Phases	1	6	5	2		4		8	
Permitted Phases					4		8		8
Detector Phase	1	6	5	2	4	4	8	8	8
Switch Phase									
Minimum Initial (s)	4.0	12.0	4.0	12.0	6.0	6.0	6.0	6.0	6.0
Minimum Split (s)	24.0	28.0	10.0	28.0	43.0	43.0	43.0	43.0	43.0
Total Split (s)	25.0	100.0	16.0	91.0	44.0	44.0	44.0	44.0	44.0
Total Split (%)	15.6%	62.5%	10.0%	56.9%	27.5%	27.5%	27.5%	27.5%	27.5%
Yellow Time (s)	4.0	4.0	4.0	4.0	4.0	4.0	4.0	4.0	4.0
All-Red Time (s)	2.0	2.0	2.0	2.0	2.0	2.0	2.0	2.0	2.0
Lost Time Adjust (s)	0.0	0.0	0.0	0.0	0.0	0.0	0.0	0.0	0.0
Total Lost Time (s)	6.0	6.0	6.0	6.0	6.0	6.0	6.0	6.0	6.0
Lead/Lag	Lead	Lag	Lead	Lag					
Lead-Lag Optimize?	Yes	Yes	Yes	Yes					
Recall Mode	None	C-Max	None	C-Max	None	None	None	None	None
Act Effct Green (s)	9.2	131.6	4.6	121.0	14.0	14.0	14.0	14.0	14.0
Actuated g/C Ratio	0.06	0.82	0.03	0.76	0.09	0.09	0.09	0.09	0.09
v/c Ratio	0.57	0.43	0.10	0.26	0.28	0.19	0.69	0.14	0.55
Control Delay	94.4	6.8	66.2	6.1	71.8	37.8	97.6	66.7	16.7
Queue Delay	0.0	0.0	0.0	0.0	0.0	0.0	0.0	0.0	0.0
Total Delay	94.4	6.8	66.2	6.1	71.8	37.8	97.6	66.7	16.7
LOS	F	A	E	A	E	D	F	E	B
Approach Delay		9.6		6.4		55.3		47.2	
Approach LOS		A		A		E		D	

Intersection Summary

Cycle Length: 160

Actuated Cycle Length: 160

Offset: 138 (86%), Referenced to phase 2:WBT and 6:EBT, Start of Yellow

Natural Cycle: 95

Control Type: Actuated-Coordinated

Maximum v/c Ratio: 0.69

Intersection Signal Delay: 12.5

Intersection LOS: B

Intersection Capacity Utilization 64.0%

ICU Level of Service C

Analysis Period (min) 15

Splits and Phases: 107: NW 76 Avenue & Atlantic Boulevard

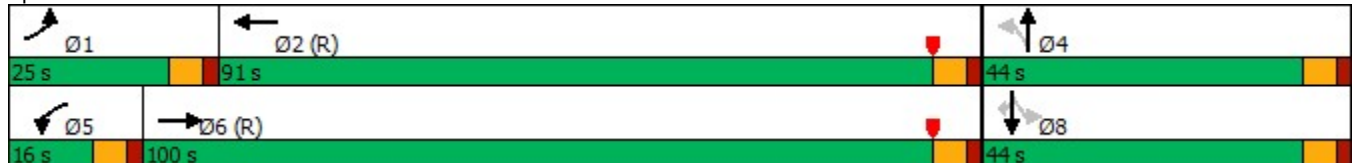

Queues

107: NW 76 Avenue & Atlantic Boulevard



Lane Group	EBL	EBT	WBL	WBT	NBL	NBT	SBL	SBT	SBR
Lane Group Flow (vph)	58	1791	5	1008	33	31	82	23	150
v/c Ratio	0.57	0.43	0.10	0.26	0.28	0.19	0.69	0.14	0.55
Control Delay	94.4	6.8	66.2	6.1	71.8	37.8	97.6	66.7	16.7
Queue Delay	0.0	0.0	0.0	0.0	0.0	0.0	0.0	0.0	0.0
Total Delay	94.4	6.8	66.2	6.1	71.8	37.8	97.6	66.7	16.7
Queue Length 50th (ft)	61	185	0	110	33	13	85	23	0
Queue Length 95th (ft)	114	242	m12	m134	68	47	142	52	70
Internal Link Dist (ft)		3088		2032		396		487	
Turn Bay Length (ft)	150		200		225		200		200
Base Capacity (vph)	210	4163	110	3812	327	413	324	442	484
Starvation Cap Reductn	0	0	0	0	0	0	0	0	0
Spillback Cap Reductn	0	0	0	0	0	0	0	0	0
Storage Cap Reductn	0	0	0	0	0	0	0	0	0
Reduced v/c Ratio	0.28	0.43	0.05	0.26	0.10	0.08	0.25	0.05	0.31

Intersection Summary

m Volume for 95th percentile queue is metered by upstream signal.

HCM 6th Signalized Intersection Summary

107: NW 76 Avenue & Atlantic Boulevard

Movement	EBL	EBT	EBR	WBL	WBT	WBR	NBL	NBT	NBR	SBL	SBT	SBR
Lane Configurations												
Traffic Volume (veh/h)	56	1668	51	5	915	53	32	12	17	79	22	144
Future Volume (veh/h)	56	1668	51	5	915	53	32	12	17	79	22	144
Initial Q (Qb), veh	0	0	0	0	0	0	0	0	0	0	0	0
Ped-Bike Adj(A_pbT)	1.00		1.00	1.00		1.00	0.99		0.98	0.99		0.98
Parking Bus, Adj	1.00	1.00	1.00	1.00	1.00	1.00	1.00	1.00	1.00	1.00	1.00	1.00
Work Zone On Approach		No			No			No			No	
Adj Sat Flow, veh/h/ln	1870	1870	1870	1870	1870	1870	1870	1870	1870	1870	1870	1870
Adj Flow Rate, veh/h	58	1738	53	5	953	55	33	12	18	82	23	150
Peak Hour Factor	0.96	0.96	0.96	0.96	0.96	0.96	0.96	0.96	0.96	0.96	0.96	0.96
Percent Heavy Veh, %	2	2	2	2	2	2	2	2	2	2	2	2
Cap, veh/h	80	3859	118	9	3548	204	182	83	124	194	233	193
Arrive On Green	0.06	1.00	1.00	0.01	0.96	0.96	0.12	0.12	0.12	0.12	0.12	0.12
Sat Flow, veh/h	1781	5091	155	1781	4938	284	1205	666	999	1371	1870	1552
Grp Volume(v), veh/h	58	1162	629	5	656	352	33	0	30	82	23	150
Grp Sat Flow(s),veh/h/ln	1781	1702	1842	1781	1702	1818	1205	0	1665	1371	1870	1552
Q Serve(g_s), s	5.1	0.0	0.0	0.4	1.8	1.9	4.0	0.0	2.6	9.1	1.7	15.0
Cycle Q Clear(g_c), s	5.1	0.0	0.0	0.4	1.8	1.9	5.7	0.0	2.6	11.6	1.7	15.0
Prop In Lane	1.00		0.08	1.00		0.16	1.00		0.60	1.00		1.00
Lane Grp Cap(c), veh/h	80	2581	1396	9	2445	1306	182	0	207	194	233	193
V/C Ratio(X)	0.73	0.45	0.45	0.56	0.27	0.27	0.18	0.00	0.14	0.42	0.10	0.78
Avail Cap(c_a), veh/h	212	2581	1396	111	2445	1306	318	0	396	349	444	369
HCM Platoon Ratio	1.33	1.33	1.33	1.33	1.33	1.33	1.00	1.00	1.00	1.00	1.00	1.00
Upstream Filter(l)	0.87	0.87	0.87	0.87	0.87	0.87	1.00	0.00	1.00	1.00	1.00	1.00
Uniform Delay (d), s/veh	74.3	0.0	0.0	79.3	1.0	1.0	64.6	0.0	62.5	67.6	62.1	67.9
Incr Delay (d2), s/veh	4.1	0.5	0.9	16.8	0.2	0.4	0.2	0.0	0.1	0.5	0.1	2.5
Initial Q Delay(d3),s/veh	0.0	0.0	0.0	0.0	0.0	0.0	0.0	0.0	0.0	0.0	0.0	0.0
%ile BackOfQ(50%),veh/ln	2.4	0.2	0.4	0.2	0.6	0.7	1.2	0.0	1.1	3.2	0.8	6.1
Unsig. Movement Delay, s/veh												
LnGrp Delay(d),s/veh	78.4	0.5	0.9	96.1	1.3	1.5	64.8	0.0	62.6	68.2	62.2	70.4
LnGrp LOS	E	A	A	F	A	A	E	A	E	E	E	E
Approach Vol, veh/h		1849			1013			63			255	
Approach Delay, s/veh		3.1			1.8			63.7			69.0	
Approach LOS		A			A			E			E	
Timer - Assigned Phs	1	2		4	5	6		8				
Phs Duration (G+Y+Rc), s	13.1	120.9		25.9	6.8	127.3		25.9				
Change Period (Y+Rc), s	6.0	6.0		6.0	6.0	6.0		6.0				
Max Green Setting (Gmax), s	19.0	85.0		38.0	10.0	94.0		38.0				
Max Q Clear Time (g_c+I1), s	7.1	3.9		7.7	2.4	2.0		17.0				
Green Ext Time (p_c), s	0.0	8.8		0.1	0.0	24.5		0.4				
Intersection Summary												
HCM 6th Ctrl Delay				9.2								
HCM 6th LOS				A								

Timings

108: Rock Island Road & Atlantic Boulevard/Atlantic Boulevard



Lane Group	EBL	EBT	WBL	WBT	NBL	NBT	NBR	SBL	SBT
Lane Configurations	↖↗	↕↗	↖↗	↕↗	↖↗	↕↕	↗	↖↗	↕↗
Traffic Volume (vph)	134	1190	254	655	258	848	431	169	796
Future Volume (vph)	134	1190	254	655	258	848	431	169	796
Turn Type	Prot	NA	Prot	NA	Prot	NA	Perm	Prot	NA
Protected Phases	1	6	5	2	7	4		3	8
Permitted Phases							4		
Detector Phase	1	6	5	2	7	4	4	3	8
Switch Phase									
Minimum Initial (s)	5.0	12.0	5.0	12.0	5.0	6.0	6.0	5.0	6.0
Minimum Split (s)	11.0	49.0	11.0	49.0	11.5	51.5	51.5	11.5	51.5
Total Split (s)	26.0	58.0	26.0	58.0	24.0	52.0	52.0	24.0	52.0
Total Split (%)	16.3%	36.3%	16.3%	36.3%	15.0%	32.5%	32.5%	15.0%	32.5%
Yellow Time (s)	4.0	4.0	4.0	4.0	4.5	4.5	4.5	4.5	4.5
All-Red Time (s)	2.0	2.0	2.0	2.0	2.0	2.0	2.0	2.0	2.0
Lost Time Adjust (s)	0.0	0.0	0.0	0.0	0.0	0.0	0.0	0.0	0.0
Total Lost Time (s)	6.0	6.0	6.0	6.0	6.5	6.5	6.5	6.5	6.5
Lead/Lag	Lead	Lag	Lead	Lag	Lead	Lag	Lag	Lead	Lag
Lead-Lag Optimize?	Yes	Yes	Yes	Yes	Yes	Yes	Yes	Yes	Yes
Recall Mode	None	C-Max	None	C-Max	None	None	None	None	None
Act Effct Green (s)	10.3	58.5	15.9	64.1	15.5	48.6	48.6	12.0	45.1
Actuated g/C Ratio	0.06	0.37	0.10	0.40	0.10	0.30	0.30	0.08	0.28
v/c Ratio	0.62	0.82	0.77	0.38	0.80	0.81	0.80	0.68	0.94
Control Delay	90.9	58.4	67.4	65.7	81.6	44.7	35.5	65.1	73.9
Queue Delay	0.0	0.0	0.0	0.0	0.0	0.0	0.0	0.0	0.0
Total Delay	90.9	58.4	67.4	65.7	81.6	44.7	35.5	65.1	73.9
LOS	F	E	E	E	F	D	D	E	E
Approach Delay		61.2		66.1		48.3			72.5
Approach LOS		E		E		D			E

Intersection Summary

Cycle Length: 160
 Actuated Cycle Length: 160
 Offset: 100 (63%), Referenced to phase 2:WBT and 6:EBT, Start of Yellow
 Natural Cycle: 125
 Control Type: Actuated-Coordinated
 Maximum v/c Ratio: 0.94
 Intersection Signal Delay: 60.6
 Intersection LOS: E
 Intersection Capacity Utilization 97.1%
 ICU Level of Service F
 Analysis Period (min) 15

Splits and Phases: 108: Rock Island Road & Atlantic Boulevard/Atlantic Boulevard

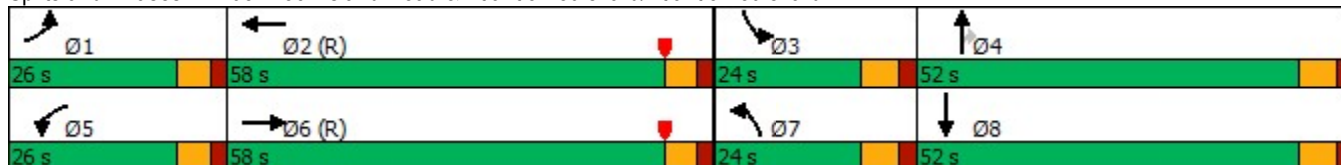

Queues

108: Rock Island Road & Atlantic Boulevard/Atlantic Boulevard



Lane Group	EBL	EBT	WBL	WBT	NBL	NBT	NBR	SBL	SBT
Lane Group Flow (vph)	138	1487	262	757	266	874	444	174	930
v/c Ratio	0.62	0.82	0.77	0.38	0.80	0.81	0.80	0.68	0.94
Control Delay	90.9	58.4	67.4	65.7	81.6	44.7	35.5	65.1	73.9
Queue Delay	0.0	0.0	0.0	0.0	0.0	0.0	0.0	0.0	0.0
Total Delay	90.9	58.4	67.4	65.7	81.6	44.7	35.5	65.1	73.9
Queue Length 50th (ft)	78	367	145	288	147	462	375	97	518
Queue Length 95th (ft)	117	449	m183	340	m170	m498	m420	125	#641
Internal Link Dist (ft)		2032		5200		2618			3616
Turn Bay Length (ft)	300		300		210		23	200	
Base Capacity (vph)	429	1824	429	2010	375	1078	555	375	1003
Starvation Cap Reductn	0	0	0	0	0	0	0	0	0
Spillback Cap Reductn	0	0	0	0	0	0	0	0	0
Storage Cap Reductn	0	0	0	0	0	0	0	0	0
Reduced v/c Ratio	0.32	0.82	0.61	0.38	0.71	0.81	0.80	0.46	0.93

Intersection Summary





























95th percentile volume exceeds capacity, queue may be longer.

Queue shown is maximum after two cycles.

m Volume for 95th percentile queue is metered by upstream signal.

HCM 6th Signalized Intersection Summary

108: Rock Island Road & Atlantic Boulevard/Atlantic Boulevard

												
Movement	EBL	EBT	EBR	WBL	WBT	WBR	NBL	NBT	NBR	SBL	SBT	SBR
Lane Configurations	 	 		 	 		 	 		 	 	
Traffic Volume (veh/h)	134	1190	252	254	655	80	258	848	431	169	796	106
Future Volume (veh/h)	134	1190	252	254	655	80	258	848	431	169	796	106
Initial Q (Qb), veh	0	0	0	0	0	0	0	0	0	0	0	0
Ped-Bike Adj(A_pbT)	1.00		0.99	1.00		1.00	1.00		1.00	1.00		0.99
Parking Bus, Adj	1.00	1.00	1.00	1.00	1.00	1.00	1.00	1.00	1.00	1.00	1.00	1.00
Work Zone On Approach		No			No			No			No	
Adj Sat Flow, veh/h/ln	1870	1870	1870	1870	1870	1870	1870	1870	1870	1870	1870	1870
Adj Flow Rate, veh/h	138	1227	260	262	675	82	266	874	444	174	821	109
Peak Hour Factor	0.97	0.97	0.97	0.97	0.97	0.97	0.97	0.97	0.97	0.97	0.97	0.97
Percent Heavy Veh, %	2	2	2	2	2	2	2	2	2	2	2	2
Cap, veh/h	181	1642	348	304	1967	237	311	1075	479	217	867	115
Arrive On Green	0.07	0.52	0.52	0.12	0.57	0.57	0.03	0.10	0.10	0.06	0.28	0.28
Sat Flow, veh/h	3456	4207	892	3456	4618	556	3456	3554	1583	3456	3147	418
Grp Volume(v), veh/h	138	993	494	262	496	261	266	874	444	174	464	466
Grp Sat Flow(s),veh/h/ln	1728	1702	1695	1728	1702	1769	1728	1777	1583	1728	1777	1788
Q Serve(g_s), s	6.3	36.7	36.7	11.9	12.5	12.7	12.3	38.6	44.5	7.9	40.9	40.9
Cycle Q Clear(g_c), s	6.3	36.7	36.7	11.9	12.5	12.7	12.3	38.6	44.5	7.9	40.9	40.9
Prop In Lane	1.00		0.53	1.00		0.31	1.00		1.00	1.00		0.23
Lane Grp Cap(c), veh/h	181	1328	661	304	1450	754	311	1075	479	217	490	493
V/C Ratio(X)	0.76	0.75	0.75	0.86	0.34	0.35	0.86	0.81	0.93	0.80	0.95	0.95
Avail Cap(c_a), veh/h	432	1328	661	432	1450	754	378	1075	479	378	505	508
HCM Platoon Ratio	1.33	1.33	1.33	1.33	1.33	1.33	0.33	0.33	0.33	1.00	1.00	1.00
Upstream Filter(I)	0.90	0.90	0.90	0.50	0.50	0.50	0.30	0.30	0.30	0.92	0.92	0.92
Uniform Delay (d), s/veh	73.5	32.3	32.3	69.7	22.6	22.7	76.6	67.6	70.3	74.0	56.8	56.8
Incr Delay (d2), s/veh	2.3	3.5	6.8	4.7	0.3	0.6	4.4	1.4	9.6	2.4	24.9	24.9
Initial Q Delay(d3),s/veh	0.0	0.0	0.0	0.0	0.0	0.0	0.0	0.0	0.0	0.0	0.0	0.0
%ile BackOfQ(50%),veh/ln	2.8	14.9	15.4	5.4	4.8	5.2	5.9	18.8	20.4	3.6	21.8	21.9
Unsig. Movement Delay, s/veh												
LnGrp Delay(d),s/veh	75.7	35.8	39.1	74.3	23.0	23.3	81.0	69.0	79.8	76.4	81.7	81.7
LnGrp LOS	E	D	D	E	C	C	F	E	E	E	F	F
Approach Vol, veh/h		1625			1019			1584			1104	
Approach Delay, s/veh		40.2			36.3			74.0			80.9	
Approach LOS		D			D			E			F	
Timer - Assigned Phs	1	2	3	4	5	6	7	8				
Phs Duration (G+Y+Rc), s	14.4	74.1	16.6	54.9	20.1	68.4	20.9	50.6				
Change Period (Y+Rc), s	6.0	6.0	6.5	6.5	6.0	6.0	6.5	6.5				
Max Green Setting (Gmax), s	20.0	52.0	17.5	45.5	20.0	52.0	17.5	45.5				
Max Q Clear Time (g_c+I1), s	8.3	14.7	9.9	46.5	13.9	38.7	14.3	42.9				
Green Ext Time (p_c), s	0.1	5.8	0.1	0.0	0.2	8.3	0.1	1.1				
Intersection Summary												
HCM 6th Ctrl Delay			57.9									
HCM 6th LOS			E									

Timings

109: SR 7 & Atlantic Boulevard

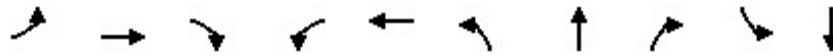

Lane Group	EBL	EBT	EBR	WBL	WBT	NBL	NBT	NBR	SBL	SBT
Lane Configurations	↖↗	↑↑↑	↗	↖↗	↑↑↑	↖	↑↑↑	↗	↖	↑↑↑
Traffic Volume (vph)	436	1278	172	271	720	109	1495	498	250	1182
Future Volume (vph)	436	1278	172	271	720	109	1495	498	250	1182
Turn Type	Prot	NA	Perm	Prot	NA	Prot	NA	Perm	Prot	NA
Protected Phases	7	4		3	8	5	2		1	6
Permitted Phases			4					2		
Detector Phase	7	4	4	3	8	5	2	2	1	6
Switch Phase										
Minimum Initial (s)	4.0	6.0	6.0	4.0	6.0	5.0	8.0	8.0	5.0	8.0
Minimum Split (s)	11.0	47.0	47.0	11.0	43.0	12.0	50.0	50.0	12.0	50.0
Total Split (s)	31.0	53.0	53.0	21.0	43.0	19.0	57.0	57.0	29.0	67.0
Total Split (%)	19.4%	33.1%	33.1%	13.1%	26.9%	11.9%	35.6%	35.6%	18.1%	41.9%
Yellow Time (s)	5.0	5.0	5.0	5.0	5.0	5.0	5.0	5.0	5.0	5.0
All-Red Time (s)	2.0	2.0	2.0	2.0	2.0	2.0	2.0	2.0	2.0	2.0
Lost Time Adjust (s)	0.0	0.0	0.0	0.0	0.0	0.0	0.0	0.0	0.0	0.0
Total Lost Time (s)	7.0	7.0	7.0	7.0	7.0	7.0	7.0	7.0	7.0	7.0
Lead/Lag	Lead	Lag	Lag	Lead	Lag	Lead	Lag	Lag	Lead	Lag
Lead-Lag Optimize?	Yes	Yes	Yes	Yes	Yes	Yes	Yes	Yes	Yes	Yes
Recall Mode	None	None	None	None	None	None	C-Max	C-Max	None	C-Max
Act Effct Green (s)	22.9	45.5	45.5	14.0	36.6	11.6	50.0	50.0	22.5	60.9
Actuated g/C Ratio	0.14	0.28	0.28	0.09	0.23	0.07	0.31	0.31	0.14	0.38
v/c Ratio	0.91	0.91	0.31	0.93	0.79	0.88	0.97	0.78	1.04	0.72
Control Delay	99.8	62.7	14.7	108.1	62.1	124.8	70.3	34.8	139.9	40.9
Queue Delay	0.0	0.0	0.0	0.0	0.0	0.0	0.0	0.0	0.0	0.0
Total Delay	99.8	62.7	14.7	108.1	62.1	124.8	70.3	34.8	139.9	40.9
LOS	F	E	B	F	E	F	E	C	F	D
Approach Delay		66.9			72.9		64.7			56.6
Approach LOS		E			E		E			E

Intersection Summary

Cycle Length: 160
 Actuated Cycle Length: 160
 Offset: 115 (72%), Referenced to phase 2:NBT and 6:SBT, Start of Yellow
 Natural Cycle: 150
 Control Type: Actuated-Coordinated
 Maximum v/c Ratio: 1.04
 Intersection Signal Delay: 64.8
 Intersection Capacity Utilization 105.7%
 Analysis Period (min) 15
 Intersection LOS: E
 ICU Level of Service G

Splits and Phases: 109: SR 7 & Atlantic Boulevard

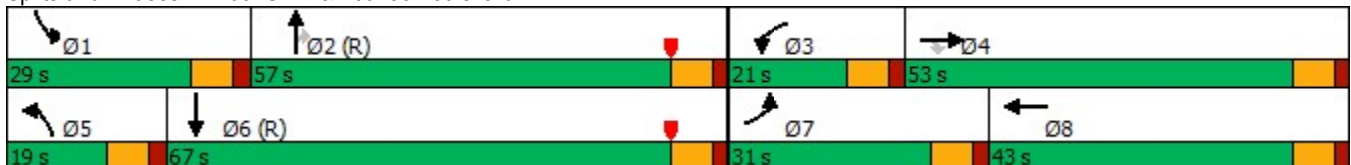

Queues

109: SR 7 & Atlantic Boulevard



Lane Group	EBL	EBT	EBR	WBL	WBT	NBL	NBT	NBR	SBL	SBT
Lane Group Flow (vph)	449	1318	177	279	906	112	1541	513	258	1368
v/c Ratio	0.91	0.91	0.31	0.93	0.79	0.88	0.97	0.78	1.04	0.72
Control Delay	99.8	62.7	14.7	108.1	62.1	124.8	70.3	34.8	139.9	40.9
Queue Delay	0.0	0.0	0.0	0.0	0.0	0.0	0.0	0.0	0.0	0.0
Total Delay	99.8	62.7	14.7	108.1	62.1	124.8	70.3	34.8	139.9	40.9
Queue Length 50th (ft)	255	361	22	152	322	118	584	273	~302	267
Queue Length 95th (ft)	m#336	472	m61	#243	378	#238	#688	435	#495	389
Internal Link Dist (ft)		5200			1156		610			2153
Turn Bay Length (ft)	275		350	520		400		260	400	
Base Capacity (vph)	514	1461	573	300	1150	132	1589	656	248	1909
Starvation Cap Reductn	0	0	0	0	0	0	0	0	0	0
Spillback Cap Reductn	0	0	0	0	0	0	0	0	0	0
Storage Cap Reductn	0	0	0	0	0	0	0	0	0	0
Reduced v/c Ratio	0.87	0.90	0.31	0.93	0.79	0.85	0.97	0.78	1.04	0.72

Intersection Summary

~ Volume exceeds capacity, queue is theoretically infinite.

Queue shown is maximum after two cycles.





































95th percentile volume exceeds capacity, queue may be longer.

Queue shown is maximum after two cycles.

m Volume for 95th percentile queue is metered by upstream signal.

HCM 6th Signalized Intersection Summary

109: SR 7 & Atlantic Boulevard

												
Movement	EBL	EBT	EBR	WBL	WBT	WBR	NBL	NBT	NBR	SBL	SBT	SBR
Lane Configurations	  	  		  	   				  		  	  
Traffic Volume (veh/h)	436	1278	172	271	720	159	109	1495	498	250	1182	145
Future Volume (veh/h)	436	1278	172	271	720	159	109	1495	498	250	1182	145
Initial Q (Qb), veh	0	0	0	0	0	0	0	0	0	0	0	0
Ped-Bike Adj(A_pbT)	1.00		1.00	1.00		1.00	1.00		0.99	1.00		0.99
Parking Bus, Adj	1.00	1.00	1.00	1.00	1.00	1.00	1.00	1.00	1.00	1.00	1.00	1.00
Work Zone On Approach		No			No			No			No	
Adj Sat Flow, veh/h/ln	1870	1870	1870	1870	1870	1870	1870	1870	1870	1870	1870	1870
Adj Flow Rate, veh/h	449	1318	177	279	742	164	112	1541	513	258	1219	149
Peak Hour Factor	0.97	0.97	0.97	0.97	0.97	0.97	0.97	0.97	0.97	0.97	0.97	0.97
Percent Heavy Veh, %	2	2	2	2	2	2	2	2	2	2	2	2
Cap, veh/h	489	1430	443	302	947	207	132	1633	504	245	1767	216
Arrive On Green	0.14	0.28	0.28	0.09	0.23	0.23	0.10	0.43	0.43	0.18	0.51	0.51
Sat Flow, veh/h	3456	5106	1580	3456	4189	916	1781	5106	1575	1781	4606	563
Grp Volume(v), veh/h	449	1318	177	279	601	305	112	1541	513	258	901	467
Grp Sat Flow(s),veh/h/ln	1728	1702	1580	1728	1702	1701	1781	1702	1575	1781	1702	1765
Q Serve(g_s), s	20.5	40.1	14.5	12.8	26.6	27.0	9.9	46.3	51.2	22.0	32.0	32.0
Cycle Q Clear(g_c), s	20.5	40.1	14.5	12.8	26.6	27.0	9.9	46.3	51.2	22.0	32.0	32.0
Prop In Lane	1.00		1.00	1.00		0.54	1.00		1.00	1.00		0.32
Lane Grp Cap(c), veh/h	489	1430	443	302	770	385	132	1633	504	245	1306	677
V/C Ratio(X)	0.92	0.92	0.40	0.92	0.78	0.79	0.85	0.94	1.02	1.05	0.69	0.69
Avail Cap(c_a), veh/h	518	1468	454	302	770	385	134	1633	504	245	1306	677
HCM Platoon Ratio	1.00	1.00	1.00	1.00	1.00	1.00	1.33	1.33	1.33	1.33	1.33	1.33
Upstream Filter(I)	0.50	0.50	0.50	1.00	1.00	1.00	1.00	1.00	1.00	0.86	0.86	0.86
Uniform Delay (d), s/veh	67.8	55.9	46.7	72.5	58.2	58.4	71.3	44.6	46.0	65.4	32.0	32.0
Incr Delay (d2), s/veh	11.8	5.3	0.2	31.8	5.0	10.4	35.8	12.4	44.8	68.0	2.6	4.9
Initial Q Delay(d3),s/veh	0.0	0.0	0.0	0.0	0.0	0.0	0.0	0.0	0.0	0.0	0.0	0.0
%ile BackOfQ(50%),veh/ln	9.9	17.9	5.8	7.1	12.0	12.8	5.8	20.5	25.3	14.4	12.9	13.8
Unsig. Movement Delay, s/veh												
LnGrp Delay(d),s/veh	79.5	61.2	46.9	104.3	63.2	68.8	107.1	56.9	90.8	133.4	34.6	36.9
LnGrp LOS	E	E	D	F	E	E	F	E	F	F	C	D
Approach Vol, veh/h		1944			1185			2166			1626	
Approach Delay, s/veh		64.1			74.3			67.6			50.9	
Approach LOS		E			E			E			D	
Timer - Assigned Phs	1	2	3	4	5	6	7	8				
Phs Duration (G+Y+Rc), s	29.0	58.2	21.0	51.8	18.8	68.4	29.6	43.2				
Change Period (Y+Rc), s	7.0	7.0	7.0	7.0	7.0	7.0	7.0	7.0				
Max Green Setting (Gmax), s	22.0	50.0	14.0	46.0	12.0	60.0	24.0	36.0				
Max Q Clear Time (g_c+I1), s	24.0	53.2	14.8	42.1	11.9	34.0	22.5	29.0				
Green Ext Time (p_c), s	0.0	0.0	0.0	2.7	0.0	11.1	0.1	2.9				
Intersection Summary												
HCM 6th Ctrl Delay			63.9									
HCM 6th LOS			E									
Notes												
User approved pedestrian interval to be less than phase max green.												

Timings

110: Southgate Boulevard & Rock Island Road

Lane Group	EBL	EBT	EBR	WBL	WBT	NBL	NBT	NBR	SBL	SBT	SBR	
Lane Configurations												
Traffic Volume (vph)	508	661	153	35	444	155	881	103	262	792	403	
Future Volume (vph)	508	661	153	35	444	155	881	103	262	792	403	
Turn Type	Prot	NA	Perm	Prot	NA	pm+pt	NA	Perm	pm+pt	NA	Perm	
Protected Phases	7	4		3	8	5	2		1	6		
Permitted Phases			4			2		2	6		6	
Detector Phase	7	4	4	3	8	5	2	2	1	6	6	
Switch Phase												
Minimum Initial (s)	5.0	6.0	6.0	5.0	6.0	4.0	12.0	12.0	4.0	12.0	12.0	
Minimum Split (s)	11.5	36.5	36.5	11.5	47.5	10.5	44.5	44.5	10.5	44.5	44.5	
Total Split (s)	26.0	49.0	49.0	26.0	49.0	19.0	66.0	66.0	19.0	66.0	66.0	
Total Split (%)	16.3%	30.6%	30.6%	16.3%	30.6%	11.9%	41.3%	41.3%	11.9%	41.3%	41.3%	
Yellow Time (s)	4.5	4.5	4.5	4.5	4.5	4.5	4.5	4.5	4.5	4.5	4.5	
All-Red Time (s)	2.0	2.0	2.0	2.0	2.0	2.0	2.0	2.0	2.0	2.0	2.0	
Lost Time Adjust (s)	0.0	0.0	0.0	0.0	0.0	0.0	0.0	0.0	0.0	0.0	0.0	
Total Lost Time (s)	6.5	6.5	6.5	6.5	6.5	6.5	6.5	6.5	6.5	6.5	6.5	
Lead/Lag	Lead	Lag	Lag	Lead	Lag	Lead	Lag	Lag	Lead	Lag	Lag	
Lead-Lag Optimize?	Yes	Yes	Yes	Yes	Yes	Yes	Yes	Yes	Yes	Yes	Yes	
Recall Mode	None	None	None	None	None	None	C-Max	C-Max	None	C-Max	C-Max	
Act Effct Green (s)	19.5	51.6	51.6	7.4	37.2	70.4	59.5	59.5	81.0	66.4	66.4	
Actuated g/C Ratio	0.12	0.32	0.32	0.05	0.23	0.44	0.37	0.37	0.51	0.42	0.42	
v/c Ratio	1.27	0.60	0.28	0.44	0.89	0.56	0.70	0.16	0.93	0.56	0.52	
Control Delay	191.0	48.4	14.3	90.2	66.8	29.5	46.1	5.4	79.7	39.6	18.4	
Queue Delay	0.0	0.0	0.0	0.0	0.0	0.0	0.0	0.0	0.0	0.0	0.0	
Total Delay	191.0	48.4	14.3	90.2	66.8	29.5	46.1	5.4	79.7	39.6	18.4	
LOS	F	D	B	F	E	C	D	A	E	D	B	
Approach Delay		99.2			67.9		40.1			40.9		
Approach LOS		F			E		D			D		

Intersection Summary

Cycle Length: 160

Actuated Cycle Length: 160

Offset: 60 (38%), Referenced to phase 2:NBTL and 6:SBTL, Start of Yellow

Natural Cycle: 145

Control Type: Actuated-Coordinated

Maximum v/c Ratio: 1.27

Intersection Signal Delay: 61.6

Intersection LOS: E

Intersection Capacity Utilization 103.6%

ICU Level of Service G

Analysis Period (min) 15

Splits and Phases: 110: Southgate Boulevard & Rock Island Road

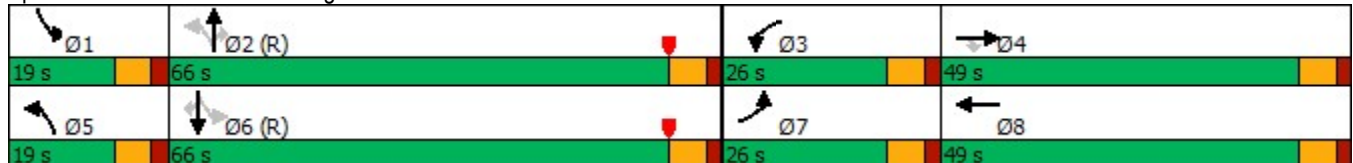

Queues

110: Southgate Boulevard & Rock Island Road



Lane Group	EBL	EBT	EBR	WBL	WBT	NBL	NBT	NBR	SBL	SBT	SBR
Lane Group Flow (vph)	529	689	159	36	741	161	918	107	273	825	420
v/c Ratio	1.27	0.60	0.28	0.44	0.89	0.56	0.70	0.16	0.93	0.56	0.52
Control Delay	191.0	48.4	14.3	90.2	66.8	29.5	46.1	5.4	79.7	39.6	18.4
Queue Delay	0.0	0.0	0.0	0.0	0.0	0.0	0.0	0.0	0.0	0.0	0.0
Total Delay	191.0	48.4	14.3	90.2	66.8	29.5	46.1	5.4	79.7	39.6	18.4
Queue Length 50th (ft)	~357	324	35	38	361	87	427	0	238	282	102
Queue Length 95th (ft)	#477	390	94	78	427	141	507	39	m#352	m337	m146
Internal Link Dist (ft)		387			374		435			2618	
Turn Bay Length (ft)	310		140	220		230			170		170
Base Capacity (vph)	418	1141	576	215	939	308	1316	650	293	1469	815
Starvation Cap Reductn	0	0	0	0	0	0	0	0	0	0	0
Spillback Cap Reductn	0	0	0	0	0	0	0	0	0	0	0
Storage Cap Reductn	0	0	0	0	0	0	0	0	0	0	0
Reduced v/c Ratio	1.27	0.60	0.28	0.17	0.79	0.52	0.70	0.16	0.93	0.56	0.52

Intersection Summary

~ Volume exceeds capacity, queue is theoretically infinite.

Queue shown is maximum after two cycles.























95th percentile volume exceeds capacity, queue may be longer.

Queue shown is maximum after two cycles.

m Volume for 95th percentile queue is metered by upstream signal.

HCM 6th Signalized Intersection Summary

110: Southgate Boulevard & Rock Island Road

												
Movement	EBL	EBT	EBR	WBL	WBT	WBR	NBL	NBT	NBR	SBL	SBT	SBR
Lane Configurations												
Traffic Volume (veh/h)	508	661	153	35	444	267	155	881	103	262	792	403
Future Volume (veh/h)	508	661	153	35	444	267	155	881	103	262	792	403
Initial Q (Qb), veh	0	0	0	0	0	0	0	0	0	0	0	0
Ped-Bike Adj(A_pbT)	1.00		1.00	1.00		0.99	1.00		1.00	1.00		1.00
Parking Bus, Adj	1.00	1.00	1.00	1.00	1.00	1.00	1.00	1.00	1.00	1.00	1.00	1.00
Work Zone On Approach		No			No			No			No	
Adj Sat Flow, veh/h/ln	1870	1870	1870	1870	1870	1870	1870	1870	1870	1870	1870	1870
Adj Flow Rate, veh/h	529	689	159	36	462	278	161	918	0	273	825	420
Peak Hour Factor	0.96	0.96	0.96	0.96	0.96	0.96	0.96	0.96	0.96	0.96	0.96	0.96
Percent Heavy Veh, %	2	2	2	2	2	2	2	2	2	2	2	2
Cap, veh/h	421	1194	530	46	512	306	278	1412		313	1454	647
Arrive On Green	0.12	0.34	0.34	0.03	0.24	0.24	0.09	0.53	0.00	0.10	0.54	0.54
Sat Flow, veh/h	3456	3554	1578	1781	2133	1275	1781	3554	1585	1781	3554	1583
Grp Volume(v), veh/h	529	689	159	36	384	356	161	918	0	273	825	420
Grp Sat Flow(s),veh/h/ln	1728	1777	1578	1781	1777	1631	1781	1777	1585	1781	1777	1583
Q Serve(g_s), s	19.5	25.6	11.9	3.2	33.6	33.9	8.6	29.7	0.0	12.5	24.5	29.9
Cycle Q Clear(g_c), s	19.5	25.6	11.9	3.2	33.6	33.9	8.6	29.7	0.0	12.5	24.5	29.9
Prop In Lane	1.00		1.00	1.00		0.78	1.00		1.00	1.00		1.00
Lane Grp Cap(c), veh/h	421	1194	530	46	427	392	278	1412		313	1454	647
V/C Ratio(X)	1.26	0.58	0.30	0.78	0.90	0.91	0.58	0.65		0.87	0.57	0.65
Avail Cap(c_a), veh/h	421	1194	530	217	472	433	298	1412		313	1454	647
HCM Platoon Ratio	1.00	1.00	1.00	1.00	1.00	1.00	1.33	1.33	1.33	1.33	1.33	1.33
Upstream Filter(l)	1.00	1.00	1.00	1.00	1.00	1.00	1.00	1.00	0.00	0.30	0.30	0.30
Uniform Delay (d), s/veh	70.3	43.8	39.2	77.4	58.9	59.1	27.1	29.7	0.0	36.1	27.1	28.4
Incr Delay (d2), s/veh	133.3	0.5	0.1	9.7	18.0	20.3	1.4	2.3	0.0	7.9	0.5	1.5
Initial Q Delay(d3),s/veh	0.0	0.0	0.0	0.0	0.0	0.0	0.0	0.0	0.0	0.0	0.0	0.0
%ile BackOfQ(50%),veh/ln	16.5	11.5	4.7	1.6	17.3	16.2	3.7	12.4	0.0	5.4	9.9	10.9
Unsig. Movement Delay, s/veh												
LnGrp Delay(d),s/veh	203.6	44.2	39.3	87.2	76.9	79.3	28.5	32.1	0.0	44.0	27.6	29.9
LnGrp LOS	F	D	D	F	E	E	C	C		D	C	C
Approach Vol, veh/h		1377			776			1079			1518	
Approach Delay, s/veh		104.9			78.5			31.5			31.2	
Approach LOS		F			E			C			C	
Timer - Assigned Phs	1	2	3	4	5	6	7	8				
Phs Duration (G+Y+Rc), s	19.0	70.1	10.7	60.3	17.1	71.9	26.0	44.9				
Change Period (Y+Rc), s	6.5	6.5	6.5	6.5	6.5	6.5	6.5	6.5				
Max Green Setting (Gmax), s	12.5	59.5	19.5	42.5	12.5	59.5	19.5	42.5				
Max Q Clear Time (g_c+I1), s	14.5	31.7	5.2	27.6	10.6	31.9	21.5	35.9				
Green Ext Time (p_c), s	0.0	7.4	0.0	3.2	0.0	8.5	0.0	1.9				
Intersection Summary												
HCM 6th Ctrl Delay				60.4								
HCM 6th LOS				E								
Notes												
Unsignalized Delay for [NBR] is excluded from calculations of the approach delay and intersection delay.												

Timings

111: NW 66 Avenue & Atlantic Boulevard

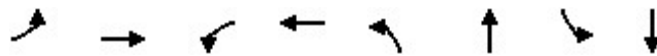

Lane Group	EBL	EBT	WBL	WBT	NBL	NBT	SBL	SBT
Lane Configurations	↖	↑↑↑	↖	↑↑↑	↖	↑	↖	↑
Traffic Volume (vph)	139	1690	16	785	63	22	119	18
Future Volume (vph)	139	1690	16	785	63	22	119	18
Turn Type	pm+pt	NA	pm+pt	NA	Perm	NA	Perm	NA
Protected Phases	1	6	5	2		4		8
Permitted Phases	6		2		4		8	
Detector Phase	1	6	5	2	4	4	8	8
Switch Phase								
Minimum Initial (s)	4.0	10.0	4.0	10.0	6.0	6.0	6.0	6.0
Minimum Split (s)	12.0	50.0	12.0	50.0	45.0	45.0	45.0	45.0
Total Split (s)	25.0	87.0	25.0	87.0	48.0	48.0	48.0	48.0
Total Split (%)	15.6%	54.4%	15.6%	54.4%	30.0%	30.0%	30.0%	30.0%
Yellow Time (s)	4.0	4.0	4.0	4.0	4.0	4.0	4.0	4.0
All-Red Time (s)	2.0	2.0	2.0	2.0	2.0	2.0	2.0	2.0
Lost Time Adjust (s)	0.0	0.0	0.0	0.0	0.0	0.0	0.0	0.0
Total Lost Time (s)	6.0	6.0	6.0	6.0	6.0	6.0	6.0	6.0
Lead/Lag	Lead	Lag	Lead	Lag				
Lead-Lag Optimize?	Yes	Yes	Yes	Yes				
Recall Mode	None	C-Max	None	C-Max	None	None	None	None
Act Effct Green (s)	105.6	99.5	95.5	90.9	42.0	42.0	42.0	42.0
Actuated g/C Ratio	0.66	0.62	0.60	0.57	0.26	0.26	0.26	0.26
v/c Ratio	0.40	0.59	0.13	0.33	0.22	0.15	0.37	0.25
Control Delay	13.3	19.6	11.9	18.6	48.6	19.6	52.1	12.5
Queue Delay	0.0	0.0	0.0	0.0	0.0	0.0	0.0	0.0
Total Delay	13.3	19.6	11.9	18.6	48.6	19.6	52.1	12.5
LOS	B	B	B	B	D	B	D	B
Approach Delay		19.2		18.4		33.9		32.4
Approach LOS		B		B		C		C

Intersection Summary

Cycle Length: 160

Actuated Cycle Length: 160

Offset: 50 (31%), Referenced to phase 2:WBTL and 6:EBTL, Start of Yellow

Natural Cycle: 110

Control Type: Actuated-Coordinated

Maximum v/c Ratio: 0.59

Intersection Signal Delay: 20.6

Intersection LOS: C

Intersection Capacity Utilization 68.4%

ICU Level of Service C

Analysis Period (min) 15

Splits and Phases: 111: NW 66 Avenue & Atlantic Boulevard

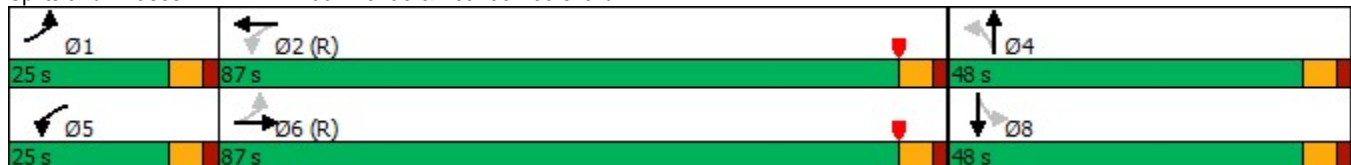

Queues

111: NW 66 Avenue & Atlantic Boulevard

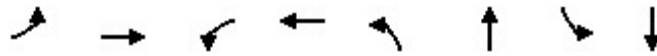





















Lane Group	EBL	EBT	WBL	WBT	NBL	NBT	SBL	SBT
Lane Group Flow (vph)	151	1869	17	937	68	70	129	127
v/c Ratio	0.40	0.59	0.13	0.33	0.22	0.15	0.37	0.25
Control Delay	13.3	19.6	11.9	18.6	48.6	19.6	52.1	12.5
Queue Delay	0.0	0.0	0.0	0.0	0.0	0.0	0.0	0.0
Total Delay	13.3	19.6	11.9	18.6	48.6	19.6	52.1	12.5
Queue Length 50th (ft)	55	440	6	181	56	19	111	16
Queue Length 95th (ft)	85	491	15	221	103	62	179	72
Internal Link Dist (ft)		2560		1156		610		2153
Turn Bay Length (ft)	200		200		190		190	
Base Capacity (vph)	457	3152	287	2853	307	469	345	499
Starvation Cap Reductn	0	0	0	0	0	0	0	0
Spillback Cap Reductn	0	0	0	0	0	0	0	0
Storage Cap Reductn	0	0	0	0	0	0	0	0
Reduced v/c Ratio	0.33	0.59	0.06	0.33	0.22	0.15	0.37	0.25

Intersection Summary

HCM 6th Signalized Intersection Summary

111: NW 66 Avenue & Atlantic Boulevard

												
Movement	EBL	EBT	EBR	WBL	WBT	WBR	NBL	NBT	NBR	SBL	SBT	SBR
Lane Configurations												
Traffic Volume (veh/h)	139	1690	29	16	785	77	63	22	42	119	18	98
Future Volume (veh/h)	139	1690	29	16	785	77	63	22	42	119	18	98
Initial Q (Qb), veh	0	0	0	0	0	0	0	0	0	0	0	0
Ped-Bike Adj(A_pbT)	1.00		1.00	1.00		0.98	0.99		0.99	0.99		0.99
Parking Bus, Adj	1.00	1.00	1.00	1.00	1.00	1.00	1.00	1.00	1.00	1.00	1.00	1.00
Work Zone On Approach		No			No			No			No	
Adj Sat Flow, veh/h/ln	1870	1870	1870	1870	1870	1870	1870	1870	1870	1870	1870	1870
Adj Flow Rate, veh/h	151	1837	32	17	853	84	68	24	46	129	20	107
Peak Hour Factor	0.92	0.92	0.92	0.92	0.92	0.92	0.92	0.92	0.92	0.92	0.92	0.92
Percent Heavy Veh, %	2	2	2	2	2	2	2	2	2	2	2	2
Cap, veh/h	485	3700	64	205	3260	319	156	90	173	207	40	215
Arrive On Green	0.04	0.72	0.72	0.01	0.69	0.69	0.21	0.21	0.21	0.21	0.21	0.21
Sat Flow, veh/h	1781	5168	90	1781	4717	462	1254	569	1090	1318	253	1355
Grp Volume(v), veh/h	151	1210	659	17	614	323	68	0	70	129	0	127
Grp Sat Flow(s),veh/h/ln	1781	1702	1854	1781	1702	1775	1254	0	1659	1318	0	1608
Q Serve(g_s), s	4.0	25.1	25.1	0.5	10.9	11.0	8.2	0.0	5.6	15.1	0.0	11.1
Cycle Q Clear(g_c), s	4.0	25.1	25.1	0.5	10.9	11.0	19.4	0.0	5.6	20.7	0.0	11.1
Prop In Lane	1.00		0.05	1.00		0.26	1.00		0.66	1.00		0.84
Lane Grp Cap(c), veh/h	485	2437	1327	205	2352	1227	156	0	263	207	0	255
V/C Ratio(X)	0.31	0.50	0.50	0.08	0.26	0.26	0.44	0.00	0.27	0.62	0.00	0.50
Avail Cap(c_a), veh/h	629	2437	1327	393	2352	1227	287	0	436	345	0	422
HCM Platoon Ratio	1.00	1.00	1.00	1.00	1.00	1.00	1.33	1.33	1.33	1.33	1.33	1.33
Upstream Filter(l)	1.00	1.00	1.00	1.00	1.00	1.00	1.00	0.00	1.00	1.00	0.00	1.00
Uniform Delay (d), s/veh	6.9	10.0	10.0	8.6	9.3	9.3	66.1	0.0	55.4	64.0	0.0	57.6
Incr Delay (d2), s/veh	0.1	0.7	1.3	0.1	0.3	0.5	0.7	0.0	0.2	1.1	0.0	0.6
Initial Q Delay(d3),s/veh	0.0	0.0	0.0	0.0	0.0	0.0	0.0	0.0	0.0	0.0	0.0	0.0
%ile BackOfQ(50%),veh/ln	1.5	9.4	10.5	0.2	4.2	4.5	2.6	0.0	2.4	5.0	0.0	4.5
Unsig. Movement Delay, s/veh												
LnGrp Delay(d),s/veh	7.0	10.7	11.4	8.6	9.6	9.9	66.8	0.0	55.6	65.2	0.0	58.1
LnGrp LOS	A	B	B	A	A	A	E	A	E	E	A	E
Approach Vol, veh/h		2020			954			138			256	
Approach Delay, s/veh		10.7			9.7			61.1			61.7	
Approach LOS		B			A			E			E	
Timer - Assigned Phs	1	2		4	5	6		8				
Phs Duration (G+Y+Rc), s	12.1	116.6		31.3	8.1	120.5		31.3				
Change Period (Y+Rc), s	6.0	6.0		6.0	6.0	6.0		6.0				
Max Green Setting (Gmax), s	19.0	81.0		42.0	19.0	81.0		42.0				
Max Q Clear Time (g_c+I1), s	6.0	13.0		21.4	2.5	27.1		22.7				
Green Ext Time (p_c), s	0.1	7.9		0.3	0.0	23.4		0.6				
Intersection Summary												
HCM 6th Ctrl Delay				16.3								
HCM 6th LOS				B								
Notes												
User approved pedestrian interval to be less than phase max green.												

HCM 6th AWSC
 112: NW 66 Avenue & Margate Boulevard

Intersection	
Intersection Delay, s/veh	14.6
Intersection LOS	B

Movement	EBL	EBT	EBR	WBL	WBT	WBR	NBL	NBT	NBR	SBL	SBT	SBR
Lane Configurations												
Traffic Vol, veh/h	88	466	57	22	125	17	35	53	61	41	69	61
Future Vol, veh/h	88	466	57	22	125	17	35	53	61	41	69	61
Peak Hour Factor	0.87	0.87	0.87	0.87	0.87	0.87	0.87	0.87	0.87	0.87	0.87	0.87
Heavy Vehicles, %	2	2	2	2	2	2	2	2	2	2	2	2
Mvmt Flow	101	536	66	25	144	20	40	61	70	47	79	70
Number of Lanes	1	2	0	0	2	0	0	1	0	0	1	0

Approach	EB	WB	NB	SB
Opposing Approach	WB	EB	SB	NB
Opposing Lanes	2	3	1	1
Conflicting Approach Left	SB	NB	EB	WB
Conflicting Lanes Left	1	1	3	2
Conflicting Approach Right	NB	SB	WB	EB
Conflicting Lanes Right	1	1	2	3
HCM Control Delay	15.6	12.3	13.5	14.3
HCM LOS	C	B	B	B

Lane	NBLn1	EBLn1	EBLn2	EBLn3	WBLn1	WBLn2	SBLn1
Vol Left, %	23%	100%	0%	0%	26%	0%	24%
Vol Thru, %	36%	0%	100%	73%	74%	79%	40%
Vol Right, %	41%	0%	0%	27%	0%	21%	36%
Sign Control	Stop	Stop	Stop	Stop	Stop	Stop	Stop
Traffic Vol by Lane	149	88	311	212	85	80	171
LT Vol	35	88	0	0	22	0	41
Through Vol	53	0	311	155	63	63	69
RT Vol	61	0	0	57	0	17	61
Lane Flow Rate	171	101	357	244	97	91	197
Geometry Grp	7	7	7	7	8	8	7
Degree of Util (X)	0.341	0.189	0.616	0.408	0.21	0.191	0.39
Departure Headway (Hd)	7.165	6.822	6.312	6.121	7.797	7.509	7.139
Convergence, Y/N	Yes	Yes	Yes	Yes	Yes	Yes	Yes
Cap	505	529	575	591	461	479	507
Service Time	4.873	4.522	4.012	3.821	5.521	5.233	4.846
HCM Lane V/C Ratio	0.339	0.191	0.621	0.413	0.21	0.19	0.389
HCM Control Delay	13.5	11.1	18.6	13	12.6	12	14.3
HCM Lane LOS	B	B	C	B	B	B	B
HCM 95th-tile Q	1.5	0.7	4.2	2	0.8	0.7	1.8

Timings

101: Rock Island Road & Royal Palm Boulevard

Lane Group	EBL	EBT	WBL	WBT	NBL	NBT	NBR	SBL	SBT	SBR
Lane Configurations										
Traffic Volume (vph)	159	971	168	808	390	625	243	237	708	177
Future Volume (vph)	159	971	168	808	390	625	243	237	708	177
Turn Type	Prot	NA	Prot	NA	pm+pt	NA	Perm	pm+pt	NA	Perm
Protected Phases	1	6	5	2	7	4		3	8	
Permitted Phases					4		4	8		8
Detector Phase	1	6	5	2	7	4	4	3	8	8
Switch Phase										
Minimum Initial (s)	5.0	10.0	5.0	10.0	4.0	6.0	6.0	4.0	6.0	6.0
Minimum Split (s)	11.5	43.5	11.5	43.5	10.5	43.5	43.5	10.5	42.0	42.0
Total Split (s)	26.0	60.0	26.0	60.0	32.0	46.0	46.0	28.0	42.0	42.0
Total Split (%)	16.3%	37.5%	16.3%	37.5%	20.0%	28.8%	28.8%	17.5%	26.3%	26.3%
Yellow Time (s)	4.5	4.5	4.5	4.5	4.5	4.5	4.5	4.5	4.5	4.5
All-Red Time (s)	2.0	2.0	2.0	2.0	2.0	2.0	2.0	2.0	2.0	2.0
Lost Time Adjust (s)	0.0	0.0	0.0	0.0	0.0	0.0	0.0	0.0	0.0	0.0
Total Lost Time (s)	6.5	6.5	6.5	6.5	6.5	6.5	6.5	6.5	6.5	6.5
Lead/Lag	Lead	Lag	Lead	Lag	Lead	Lag	Lag	Lead	Lag	Lag
Lead-Lag Optimize?	Yes	Yes	Yes	Yes	Yes	Yes	Yes	Yes	Yes	Yes
Recall Mode	None	C-Max	None	C-Max	None	None	None	None	None	None
Act Effct Green (s)	17.8	54.6	18.4	55.2	66.0	41.6	41.6	54.9	35.5	35.5
Actuated g/C Ratio	0.11	0.34	0.12	0.34	0.41	0.26	0.26	0.34	0.22	0.22
v/c Ratio	0.88	1.25	0.90	0.92	1.30	0.74	0.50	0.86	0.98	0.44
Control Delay	108.2	162.4	110.7	61.8	196.5	80.8	42.2	60.5	88.9	25.5
Queue Delay	0.0	0.0	0.0	0.0	0.0	0.0	0.0	0.0	0.0	0.0
Total Delay	108.2	162.4	110.7	61.8	196.5	80.8	42.2	60.5	88.9	25.5
LOS	F	F	F	E	F	F	D	E	F	C
Approach Delay		156.7		68.8		109.2			72.9	
Approach LOS		F		E		F			E	

Intersection Summary

Cycle Length: 160	
Actuated Cycle Length: 160	
Offset: 49 (31%), Referenced to phase 2:WBT and 6:EBT, Start of Yellow	
Natural Cycle: 150	
Control Type: Actuated-Coordinated	
Maximum v/c Ratio: 1.30	
Intersection Signal Delay: 106.1	Intersection LOS: F
Intersection Capacity Utilization 111.8%	ICU Level of Service H
Analysis Period (min) 15	

Splits and Phases: 101: Rock Island Road & Royal Palm Boulevard

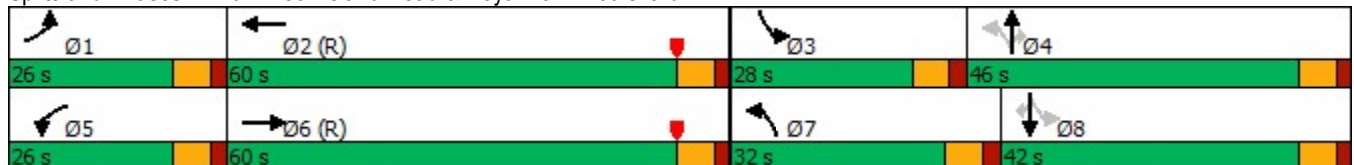

Queues

101: Rock Island Road & Royal Palm Boulevard



Lane Group	EBL	EBT	WBL	WBT	NBL	NBT	NBR	SBL	SBT	SBR
Lane Group Flow (vph)	173	1479	183	1093	424	679	264	258	770	192
v/c Ratio	0.88	1.25	0.90	0.92	1.30	0.74	0.50	0.86	0.98	0.44
Control Delay	108.2	162.4	110.7	61.8	196.5	80.8	42.2	60.5	88.9	25.5
Queue Delay	0.0	0.0	0.0	0.0	0.0	0.0	0.0	0.0	0.0	0.0
Total Delay	108.2	162.4	110.7	61.8	196.5	80.8	42.2	60.5	88.9	25.5
Queue Length 50th (ft)	179	~1015	191	578	~527	376	140	181	426	70
Queue Length 95th (ft)	#304	#1155	#330	#719	#726	455	239	#301	#565	152
Internal Link Dist (ft)		625		856		3088			735	
Turn Bay Length (ft)	300		200		200		160	140		170
Base Capacity (vph)	215	1182	215	1194	327	920	527	323	785	432
Starvation Cap Reductn	0	0	0	0	0	0	0	0	0	0
Spillback Cap Reductn	0	0	0	0	0	0	0	0	0	0
Storage Cap Reductn	0	0	0	0	0	0	0	0	0	0
Reduced v/c Ratio	0.80	1.25	0.85	0.92	1.30	0.74	0.50	0.80	0.98	0.44

Intersection Summary

~ Volume exceeds capacity, queue is theoretically infinite.























Queue shown is maximum after two cycles.

95th percentile volume exceeds capacity, queue may be longer.

Queue shown is maximum after two cycles.

HCM 6th Signalized Intersection Summary

101: Rock Island Road & Royal Palm Boulevard

												
Movement	EBL	EBT	EBR	WBL	WBT	WBR	NBL	NBT	NBR	SBL	SBT	SBR
Lane Configurations												
Traffic Volume (veh/h)	159	971	390	168	808	198	390	625	243	237	708	177
Future Volume (veh/h)	159	971	390	168	808	198	390	625	243	237	708	177
Initial Q (Qb), veh	0	0	0	0	0	0	0	0	0	0	0	0
Ped-Bike Adj(A_pbT)	1.00		1.00	1.00		0.99	1.00		0.99	1.00		0.98
Parking Bus, Adj	1.00	1.00	1.00	1.00	1.00	1.00	1.00	1.00	1.00	1.00	1.00	1.00
Work Zone On Approach		No			No			No			No	
Adj Sat Flow, veh/h/ln	1870	1870	1870	1870	1870	1870	1870	1870	1870	1870	1870	1870
Adj Flow Rate, veh/h	173	1055	424	183	878	215	424	679	264	258	770	192
Peak Hour Factor	0.92	0.92	0.92	0.92	0.92	0.92	0.92	0.92	0.92	0.92	0.92	0.92
Percent Heavy Veh, %	2	2	2	2	2	2	2	2	2	2	2	2
Cap, veh/h	193	853	336	202	982	240	333	915	402	323	788	346
Arrive On Green	0.14	0.46	0.46	0.15	0.46	0.46	0.27	0.43	0.43	0.12	0.22	0.22
Sat Flow, veh/h	1781	2489	982	1781	2822	691	1781	3554	1561	1781	3554	1559
Grp Volume(v), veh/h	173	748	731	183	553	540	424	679	264	258	770	192
Grp Sat Flow(s),veh/h/ln	1781	1777	1694	1781	1777	1736	1781	1777	1561	1781	1777	1559
Q Serve(g_s), s	15.3	54.8	54.8	16.2	45.6	45.7	25.5	25.6	21.5	17.7	34.4	17.5
Cycle Q Clear(g_c), s	15.3	54.8	54.8	16.2	45.6	45.7	25.5	25.6	21.5	17.7	34.4	17.5
Prop In Lane	1.00		0.58	1.00		0.40	1.00		1.00	1.00		1.00
Lane Grp Cap(c), veh/h	193	609	580	202	619	604	333	915	402	323	788	346
V/C Ratio(X)	0.90	1.23	1.26	0.90	0.89	0.89	1.27	0.74	0.66	0.80	0.98	0.56
Avail Cap(c_a), veh/h	217	609	580	217	619	604	333	915	402	342	788	346
HCM Platoon Ratio	1.33	1.33	1.33	1.33	1.33	1.33	1.67	1.67	1.67	1.00	1.00	1.00
Upstream Filter(I)	1.00	1.00	1.00	1.00	1.00	1.00	0.93	0.93	0.93	1.00	1.00	1.00
Uniform Delay (d), s/veh	67.6	43.5	43.5	67.1	40.2	40.3	42.5	41.1	40.0	42.2	61.8	55.2
Incr Delay (d2), s/veh	30.8	116.7	130.6	33.6	17.8	18.2	143.5	2.7	2.9	10.7	26.2	1.2
Initial Q Delay(d3),s/veh	0.0	0.0	0.0	0.0	0.0	0.0	0.0	0.0	0.0	0.0	0.0	0.0
%ile BackOfQ(50%),veh/ln	8.4	42.5	42.7	9.1	21.9	21.5	23.5	10.6	7.9	8.9	18.4	7.1
Unsig. Movement Delay, s/veh												
LnGrp Delay(d),s/veh	98.5	160.2	174.2	100.6	58.0	58.5	185.9	43.8	42.8	53.0	88.0	56.4
LnGrp LOS	F	F	F	F	E	E	F	D	D	D	F	E
Approach Vol, veh/h		1652			1276			1367			1220	
Approach Delay, s/veh		159.9			64.3			87.7			75.6	
Approach LOS		F			E			F			E	
Timer - Assigned Phs	1	2	3	4	5	6	7	8				
Phs Duration (G+Y+Rc), s	23.8	62.2	26.3	47.7	24.7	61.3	32.0	42.0				
Change Period (Y+Rc), s	6.5	6.5	6.5	6.5	6.5	6.5	6.5	6.5				
Max Green Setting (Gmax), s	19.5	53.5	21.5	39.5	19.5	53.5	25.5	35.5				
Max Q Clear Time (g_c+I1), s	17.3	47.7	19.7	27.6	18.2	56.8	27.5	36.4				
Green Ext Time (p_c), s	0.0	3.4	0.1	3.0	0.0	0.0	0.0	0.0				
Intersection Summary												
HCM 6th Ctrl Delay			101.3									
HCM 6th LOS			F									
Notes												
User approved pedestrian interval to be less than phase max green.												

HCM 6th TWSC
102: NW 76 Avenue & Margate Boulevard

Intersection						
Int Delay, s/veh	3.6					
Movement	EBT	EBR	WBL	WBT	NBL	NBR
Lane Configurations	↑↑		↖	↑↑	↘	
Traffic Vol, veh/h	98	152	68	57	71	58
Future Vol, veh/h	98	152	68	57	71	58
Conflicting Peds, #/hr	0	2	2	0	3	2
Sign Control	Free	Free	Free	Free	Stop	Stop
RT Channelized	-	None	-	None	-	None
Storage Length	-	-	100	-	0	-
Veh in Median Storage, #	0	-	-	0	1	-
Grade, %	0	-	-	0	0	-
Peak Hour Factor	85	85	85	85	85	85
Heavy Vehicles, %	2	2	2	2	2	2
Mvmt Flow	115	179	80	67	84	68

Major/Minor	Major1	Major2	Minor1	Minor2	Minor3
Conflicting Flow All	0	0	296	0	404
Stage 1	-	-	-	-	207
Stage 2	-	-	-	-	197
Critical Hdwy	-	-	4.14	-	5
Critical Hdwy Stg 1	-	-	-	-	5
Critical Hdwy Stg 2	-	-	-	-	5
Follow-up Hdwy	-	-	2.22	-	3
Pot Cap-1 Maneuver	-	-	1262	-	806
Stage 1	-	-	-	-	980
Stage 2	-	-	-	-	990
Platoon blocked, %	-	-	-	-	-
Mov Cap-1 Maneuver	-	-	1260	-	751
Mov Cap-2 Maneuver	-	-	-	-	775
Stage 1	-	-	-	-	978
Stage 2	-	-	-	-	925

Approach	EB	WB	NB
HCM Control Delay, s	0	4.4	9.9
HCM LOS			A

Minor Lane/Major Mvmt	NBLn1	EBT	EBR	WBL	WBT
Capacity (veh/h)	879	-	-	1260	-
HCM Lane V/C Ratio	0.173	-	-	0.063	-
HCM Control Delay (s)	9.9	-	-	8.1	-
HCM Lane LOS	A	-	-	A	-
HCM 95th %tile Q(veh)	0.6	-	-	0.2	-

Timings

103: Rock Island Road & Margate Boulevard



Lane Group	EBL	EBT	WBL	WBT	NBL	NBT	NBR	SBL	SBT	SBR
Lane Configurations										
Traffic Volume (vph)	63	99	151	64	13	855	341	180	960	53
Future Volume (vph)	63	99	151	64	13	855	341	180	960	53
Turn Type	pm+pt	NA	pm+pt	NA	pm+pt	NA	Perm	pm+pt	NA	Perm
Protected Phases	7	4	3	8	5	2		1	6	
Permitted Phases	4		8		2		2	6		6
Detector Phase	7	4	3	8	5	2	2	1	6	6
Switch Phase										
Minimum Initial (s)	4.0	6.0	4.0	6.0	4.0	12.0	12.0	4.0	12.0	12.0
Minimum Split (s)	10.0	37.0	10.0	37.0	10.5	37.5	37.5	10.5	37.5	37.5
Total Split (s)	19.0	40.0	19.0	40.0	23.0	78.0	78.0	23.0	78.0	78.0
Total Split (%)	11.9%	25.0%	11.9%	25.0%	14.4%	48.8%	48.8%	14.4%	48.8%	48.8%
Yellow Time (s)	4.0	4.0	4.0	4.0	4.5	4.5	4.5	4.5	4.5	4.5
All-Red Time (s)	2.0	2.0	2.0	2.0	2.0	2.0	2.0	2.0	2.0	2.0
Lost Time Adjust (s)	0.0	0.0	0.0	0.0	0.0	0.0	0.0	0.0	0.0	0.0
Total Lost Time (s)	6.0	6.0	6.0	6.0	6.5	6.5	6.5	6.5	6.5	6.5
Lead/Lag	Lead	Lag	Lead	Lag	Lead	Lag	Lag	Lead	Lag	Lag
Lead-Lag Optimize?	Yes	Yes	Yes	Yes	Yes	Yes	Yes	Yes	Yes	Yes
Recall Mode	None	None	None	None	None	C-Max	C-Max	None	C-Max	C-Max
Act Effct Green (s)	18.8	9.7	25.8	13.2	107.9	103.5	103.5	119.0	114.7	114.7
Actuated g/C Ratio	0.12	0.06	0.16	0.08	0.67	0.65	0.65	0.74	0.72	0.72
v/c Ratio	0.38	0.58	0.74	0.44	0.04	0.39	0.33	0.44	0.40	0.05
Control Delay	62.0	73.1	80.7	35.6	8.4	12.8	5.2	8.2	4.9	0.0
Queue Delay	0.0	0.0	0.0	0.0	0.0	0.0	0.0	0.0	0.0	0.0
Total Delay	62.0	73.1	80.7	35.6	8.4	12.8	5.2	8.2	4.9	0.0
LOS	E	E	F	D	A	B	A	A	A	A
Approach Delay		69.4		58.8		10.6			5.2	
Approach LOS		E		E		B			A	

Intersection Summary

Cycle Length: 160

Actuated Cycle Length: 160

Offset: 90 (56%), Referenced to phase 2:NBTL and 6:SBTL, Start of Yellow

Natural Cycle: 95

Control Type: Actuated-Coordinated

Maximum v/c Ratio: 0.74

Intersection Signal Delay: 17.1

Intersection LOS: B

Intersection Capacity Utilization 71.3%

ICU Level of Service C

Analysis Period (min) 15

Splits and Phases: 103: Rock Island Road & Margate Boulevard

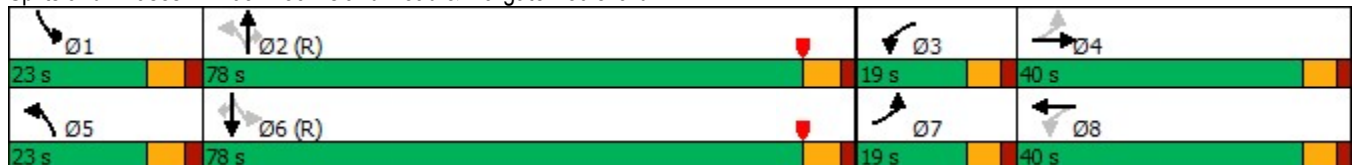

Queues

103: Rock Island Road & Margate Boulevard



Lane Group	EBL	EBT	WBL	WBT	NBL	NBT	NBR	SBL	SBT	SBR
Lane Group Flow (vph)	66	131	159	150	14	900	359	189	1011	53
v/c Ratio	0.38	0.58	0.74	0.44	0.04	0.39	0.33	0.44	0.40	0.05
Control Delay	62.0	73.1	80.7	35.6	8.4	12.8	5.2	8.2	4.9	0.0
Queue Delay	0.0	0.0	0.0	0.0	0.0	0.0	0.0	0.0	0.0	0.0
Total Delay	62.0	73.1	80.7	35.6	8.4	12.8	5.2	8.2	4.9	0.0
Queue Length 50th (ft)	60	61	152	35	3	132	11	30	87	0
Queue Length 95th (ft)	105	97	#240	74	m7	222	m88	m36	m103	m0
Internal Link Dist (ft)		2155		508		3616			3088	
Turn Bay Length (ft)	320		110		180		180	190		160
Base Capacity (vph)	218	740	217	754	497	2289	1096	491	2537	1165
Starvation Cap Reductn	0	0	0	0	0	0	0	0	0	0
Spillback Cap Reductn	0	0	0	0	0	0	0	0	0	0
Storage Cap Reductn	0	0	0	0	0	0	0	0	0	0
Reduced v/c Ratio	0.30	0.18	0.73	0.20	0.03	0.39	0.33	0.38	0.40	0.05

Intersection Summary























95th percentile volume exceeds capacity, queue may be longer.

Queue shown is maximum after two cycles.

m Volume for 95th percentile queue is metered by upstream signal.

HCM 6th Signalized Intersection Summary

103: Rock Island Road & Margate Boulevard

												
Movement	EBL	EBT	EBR	WBL	WBT	WBR	NBL	NBT	NBR	SBL	SBT	SBR
Lane Configurations												
Traffic Volume (veh/h)	63	99	26	151	64	79	13	855	341	180	960	53
Future Volume (veh/h)	63	99	26	151	64	79	13	855	341	180	960	53
Initial Q (Qb), veh	0	0	0	0	0	0	0	0	0	0	0	0
Ped-Bike Adj(A_pbT)	0.99		0.99	1.00		0.99	1.00		1.00	1.00		1.00
Parking Bus, Adj	1.00	1.00	1.00	1.00	1.00	1.00	1.00	1.00	1.00	1.00	1.00	1.00
Work Zone On Approach		No			No			No			No	
Adj Sat Flow, veh/h/ln	1870	1870	1870	1870	1870	1870	1870	1870	1870	1870	1870	1870
Adj Flow Rate, veh/h	66	104	27	159	67	83	14	900	359	189	1011	53
Peak Hour Factor	0.95	0.95	0.95	0.95	0.95	0.95	0.95	0.95	0.95	0.95	0.95	1.00
Percent Heavy Veh, %	2	2	2	2	2	2	2	2	2	2	2	2
Cap, veh/h	188	182	46	224	181	160	408	2306	1027	395	2438	1086
Arrive On Green	0.04	0.06	0.06	0.08	0.10	0.10	0.02	0.86	0.84	0.06	0.91	0.91
Sat Flow, veh/h	1781	2808	704	1781	1777	1576	1781	3554	1583	1781	3554	1583
Grp Volume(v), veh/h	66	64	67	159	67	83	14	900	359	189	1011	53
Grp Sat Flow(s),veh/h/ln	1781	1777	1736	1781	1777	1576	1781	1777	1583	1781	1777	1583
Q Serve(g_s), s	5.5	5.6	6.0	13.0	5.6	8.0	0.4	8.4	8.0	5.7	6.4	0.5
Cycle Q Clear(g_c), s	5.5	5.6	6.0	13.0	5.6	8.0	0.4	8.4	8.0	5.7	6.4	0.5
Prop In Lane	1.00		0.41	1.00		1.00	1.00		1.00	1.00		1.00
Lane Grp Cap(c), veh/h	188	115	112	224	181	160	408	2306	1027	395	2438	1086
V/C Ratio(X)	0.35	0.56	0.59	0.71	0.37	0.52	0.03	0.39	0.35	0.48	0.41	0.05
Avail Cap(c_a), veh/h	253	378	369	224	378	335	571	2306	1027	492	2438	1086
HCM Platoon Ratio	1.00	1.00	1.00	1.00	1.00	1.00	1.33	1.33	1.30	1.33	1.33	1.33
Upstream Filter(l)	1.00	1.00	1.00	1.00	1.00	1.00	0.45	0.45	0.45	0.30	0.30	0.30
Uniform Delay (d), s/veh	65.9	72.6	72.8	62.6	67.1	68.2	9.3	4.4	5.0	8.1	2.5	2.2
Incr Delay (d2), s/veh	0.4	1.6	1.8	8.5	0.5	1.0	0.0	0.2	0.4	0.1	0.2	0.0
Initial Q Delay(d3),s/veh	0.0	0.0	0.0	0.0	0.0	0.0	0.0	0.0	0.0	0.0	0.0	0.0
%ile BackOfQ(50%),veh/ln	2.5	2.6	2.7	6.6	2.6	3.3	0.2	2.5	2.4	2.1	1.7	0.2
Unsig. Movement Delay, s/veh												
LnGrp Delay(d),s/veh	66.4	74.2	74.6	71.2	67.6	69.1	9.3	4.6	5.4	8.2	2.6	2.2
LnGrp LOS	E	E	E	E	E	E	A	A	A	A	A	A
Approach Vol, veh/h		197			309			1273			1253	
Approach Delay, s/veh		71.7			69.8			4.9			3.5	
Approach LOS		E			E			A			A	
Timer - Assigned Phs	1	2	3	4	5	6	7	8				
Phs Duration (G+Y+Rc), s	14.3	110.3	19.0	16.4	8.4	116.3	13.1	22.3				
Change Period (Y+Rc), s	6.5	6.5	6.0	6.0	6.5	6.5	6.0	6.0				
Max Green Setting (Gmax), s	16.5	71.5	13.0	34.0	16.5	71.5	13.0	34.0				
Max Q Clear Time (g_c+I1), s	7.7	10.4	15.0	8.0	2.4	8.4	7.5	10.0				
Green Ext Time (p_c), s	0.1	10.3	0.0	0.4	0.0	10.0	0.0	0.5				
Intersection Summary												
HCM 6th Ctrl Delay			15.3									
HCM 6th LOS			B									

Timings

104: SR 7 & Margate Boulevard



Lane Group	EBL	EBR	NBL	NBT	SBL	SBT	Ø3
Lane Configurations	↖↗	↗	↖	↑↑↑	↖	↑↑↑	
Traffic Volume (vph)	526	182	38	2188	6	1760	
Future Volume (vph)	526	182	38	2188	6	1760	
Turn Type	Prot	Perm	Prot	NA	Prot	NA	
Protected Phases	4		5	2	1	6	3
Permitted Phases		4					
Detector Phase	4	4	5	2	1	6	
Switch Phase							
Minimum Initial (s)	7.0	7.0	4.0	12.0	4.0	12.0	5.0
Minimum Split (s)	44.5	44.5	11.5	43.0	10.0	44.5	19.0
Total Split (s)	45.0	45.0	15.0	81.0	15.0	81.0	19.0
Total Split (%)	28.1%	28.1%	9.4%	50.6%	9.4%	50.6%	12%
Yellow Time (s)	4.0	4.0	4.0	4.0	4.0	4.0	4.0
All-Red Time (s)	2.5	2.5	2.0	2.0	2.0	2.0	2.5
Lost Time Adjust (s)	0.0	0.0	0.0	0.0	0.0	0.0	
Total Lost Time (s)	6.5	6.5	6.0	6.0	6.0	6.0	
Lead/Lag	Lag	Lag	Lead	Lag	Lead	Lag	Lead
Lead-Lag Optimize?	Yes	Yes	Yes	Yes	Yes	Yes	Yes
Recall Mode	None	None	None	C-Max	None	C-Max	None
Act Effect Green (s)	29.4	29.4	7.4	115.7	4.7	106.6	
Actuated g/C Ratio	0.18	0.18	0.05	0.72	0.03	0.67	
v/c Ratio	0.85	0.42	0.48	0.61	0.12	0.57	
Control Delay	76.3	9.5	50.6	27.5	80.0	16.3	
Queue Delay	0.0	0.0	0.0	0.0	0.0	0.0	
Total Delay	76.3	9.5	50.6	27.5	80.0	16.3	
LOS	E	A	D	C	E	B	
Approach Delay				27.9		16.5	
Approach LOS				C		B	

Intersection Summary

Cycle Length: 160
 Actuated Cycle Length: 160
 Offset: 138 (86%), Referenced to phase 2:NBT and 6:SBT, Start of Yellow
 Natural Cycle: 140
 Control Type: Actuated-Coordinated
 Maximum v/c Ratio: 0.85
 Intersection Signal Delay: 28.1
 Intersection Capacity Utilization 65.6%
 Analysis Period (min) 15
 Intersection LOS: C
 ICU Level of Service C

Splits and Phases: 104: SR 7 & Margate Boulevard

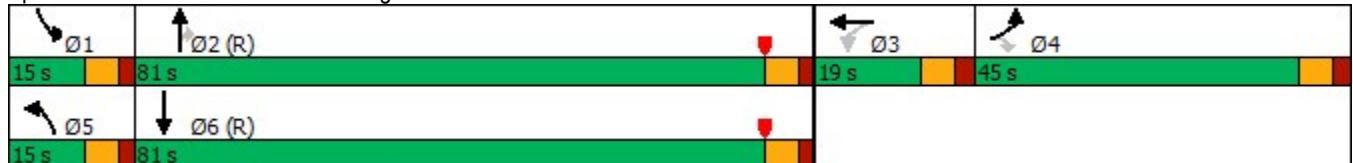

Queues

104: SR 7 & Margate Boulevard



Lane Group	EBL	EBR	NBL	NBT	SBL	SBT
Lane Group Flow (vph)	537	186	39	2233	6	1900
v/c Ratio	0.85	0.42	0.48	0.61	0.12	0.57
Control Delay	76.3	9.5	50.6	27.5	80.0	16.3
Queue Delay	0.0	0.0	0.0	0.0	0.0	0.0
Total Delay	76.3	9.5	50.6	27.5	80.0	16.3
Queue Length 50th (ft)	283	0	39	588	6	382
Queue Length 95th (ft)	336	67	m37	m602	24	503
Internal Link Dist (ft)				2153		276
Turn Bay Length (ft)	120	120	250		200	
Base Capacity (vph)	826	517	103	3676	99	3360
Starvation Cap Reductn	0	0	0	0	0	0
Spillback Cap Reductn	0	0	0	0	0	0
Storage Cap Reductn	0	0	0	0	0	0
Reduced v/c Ratio	0.65	0.36	0.38	0.61	0.06	0.57

Intersection Summary

m Volume for 95th percentile queue is metered by upstream signal.

HCM Signalized Intersection Capacity Analysis

104: SR 7 & Margate Boulevard

Movement	EBL	EBT	EBR	WBL	WBT	WBR	NBL	NBT	NBR	SBL	SBT	SBR
Lane Configurations												
Traffic Volume (vph)	526	0	182	0	0	0	38	2188	0	6	1760	102
Future Volume (vph)	526	0	182	0	0	0	38	2188	0	6	1760	102
Ideal Flow (vphpl)	1900	1900	1900	1900	1900	1900	1900	1900	1900	1900	1900	1900
Total Lost time (s)	6.5		6.5				6.0	6.0		6.0	6.0	
Lane Util. Factor	0.97		1.00				1.00	0.91		1.00	0.91	
Frbp, ped/bikes	1.00		0.99				1.00	1.00		1.00	1.00	
Flpb, ped/bikes	1.00		1.00				1.00	1.00		1.00	1.00	
Frt	1.00		0.85				1.00	1.00		1.00	0.99	
Flt Protected	0.95		1.00				0.95	1.00		0.95	1.00	
Satd. Flow (prot)	3433		1562				1770	5085		1770	5037	
Flt Permitted	0.95		1.00				0.95	1.00		0.95	1.00	
Satd. Flow (perm)	3433		1562				1770	5085		1770	5037	
Peak-hour factor, PHF	0.98	0.98	0.98	0.98	0.98	0.98	0.98	0.98	0.98	0.98	0.98	0.98
Adj. Flow (vph)	537	0	186	0	0	0	39	2233	0	6	1796	104
RTOR Reduction (vph)	0	0	152	0	0	0	0	0	0	0	2	0
Lane Group Flow (vph)	537	0	34	0	0	0	39	2233	0	6	1898	0
Confl. Peds. (#/hr)			1	1			1					1
Turn Type	Prot		Perm				Prot	NA	Perm	Prot	NA	
Protected Phases	4				3		5	2		1	6	
Permitted Phases			4	3					2			
Actuated Green, G (s)	29.4		29.4				6.6	110.9		1.2	105.5	
Effective Green, g (s)	29.4		29.4				6.6	110.9		1.2	105.5	
Actuated g/C Ratio	0.18		0.18				0.04	0.69		0.01	0.66	
Clearance Time (s)	6.5		6.5				6.0	6.0		6.0	6.0	
Vehicle Extension (s)	2.0		2.0				1.5	3.0		1.5	3.0	
Lane Grp Cap (vph)	630		287				73	3524		13	3321	
v/s Ratio Prot	c0.16						c0.02	c0.44		0.00	0.38	
v/s Ratio Perm			0.02									
v/c Ratio	0.85		0.12				0.53	0.63		0.46	0.57	
Uniform Delay, d1	63.2		54.5				75.2	13.4		79.1	14.9	
Progression Factor	1.00		1.00				0.66	2.26		1.00	1.00	
Incremental Delay, d2	10.4		0.1				0.3	0.1		9.1	0.7	
Delay (s)	73.6		54.6				50.2	30.5		88.2	15.6	
Level of Service	E		D				D	C		F	B	
Approach Delay (s)		68.7			0.0			30.8			15.8	
Approach LOS		E			A			C			B	
Intersection Summary												
HCM 2000 Control Delay			30.6				HCM 2000 Level of Service			C		
HCM 2000 Volume to Capacity ratio			0.72									
Actuated Cycle Length (s)			160.0				Sum of lost time (s)			25.0		
Intersection Capacity Utilization			65.6%				ICU Level of Service			C		
Analysis Period (min)			15									
c Critical Lane Group												

HCM 6th Signalized Intersection Summary
104: SR 7 & Margate Boulevard

HCM 6th Edition methodology expects strict NEMA phasing.

Timings

105: Riverside Drive & Atlantic Boulevard /Atlantic Boulevard

Lane Group	EBL	EBT	EBR	WBL	WBT	WBR	NBL	NBT	NBR	SBL	SBT	SBR
Lane Configurations												
Traffic Volume (vph)	101	964	72	203	728	250	22	617	363	346	431	180
Future Volume (vph)	101	964	72	203	728	250	22	617	363	346	431	180
Turn Type	Prot	NA	Perm	Prot	NA	Perm	Prot	NA	Perm	Prot	NA	Perm
Protected Phases	1	6		5	2		7	4		3	8	
Permitted Phases			6			2			4			8
Detector Phase	1	6	6	5	2	2	7	4	4	3	8	8
Switch Phase												
Minimum Initial (s)	5.0	12.0	12.0	5.0	12.0	12.0	4.0	6.0	6.0	5.0	6.0	6.0
Minimum Split (s)	11.0	36.0	36.0	24.0	36.0	36.0	10.0	32.0	32.0	11.0	20.0	20.0
Total Split (s)	60.0	50.0	50.0	60.0	50.0	50.0	30.0	32.0	32.0	18.0	20.0	20.0
Total Split (%)	37.5%	31.3%	31.3%	37.5%	31.3%	31.3%	18.8%	20.0%	20.0%	11.3%	12.5%	12.5%
Yellow Time (s)	4.0	5.0	5.0	4.0	5.0	5.0	4.0	5.0	5.0	4.0	5.0	5.0
All-Red Time (s)	2.0	2.0	2.0	2.0	2.0	2.0	2.0	2.0	2.0	2.0	2.0	2.0
Lost Time Adjust (s)	0.0	0.0	0.0	0.0	0.0	0.0	0.0	0.0	0.0	0.0	0.0	0.0
Total Lost Time (s)	6.0	7.0	7.0	6.0	7.0	7.0	6.0	7.0	7.0	6.0	7.0	7.0
Lead/Lag	Lead	Lag	Lag	Lead	Lag	Lag	Lead	Lag	Lag	Lead	Lag	Lag
Lead-Lag Optimize?	Yes	Yes	Yes	Yes	Yes	Yes	Yes	Yes	Yes	Yes	Yes	Yes
Recall Mode	None	C-Max	C-Max	None	C-Max	C-Max	None	None	None	None	None	None
Act Effct Green (s)	9.2	82.4	82.4	14.6	87.8	87.8	5.1	25.0	25.0	12.0	36.0	36.0
Actuated g/C Ratio	0.06	0.52	0.52	0.09	0.55	0.55	0.03	0.16	0.16	0.08	0.22	0.22
v/c Ratio	0.57	0.41	0.09	0.72	0.29	0.28	0.22	1.24	0.70	1.49	0.60	0.39
Control Delay	84.4	24.8	0.2	72.5	17.6	10.5	79.8	176.9	13.9	288.3	60.4	8.9
Queue Delay	0.0	0.0	0.0	0.0	0.0	0.0	0.0	0.0	0.0	0.0	0.0	0.0
Total Delay	84.4	24.8	0.2	72.5	17.6	10.5	79.8	176.9	13.9	288.3	60.4	8.9
LOS	F	C	A	E	B	B	E	F	B	F	E	A
Approach Delay		28.5			25.5			115.8			133.0	
Approach LOS		C			C			F			F	

Intersection Summary

Cycle Length: 160

Actuated Cycle Length: 160

Offset: 0 (0%), Referenced to phase 2:WBT and 6:EBT, Start of Yellow

Natural Cycle: 105

Control Type: Actuated-Coordinated

Maximum v/c Ratio: 1.49

Intersection Signal Delay: 71.5

Intersection LOS: E

Intersection Capacity Utilization 78.6%

ICU Level of Service D





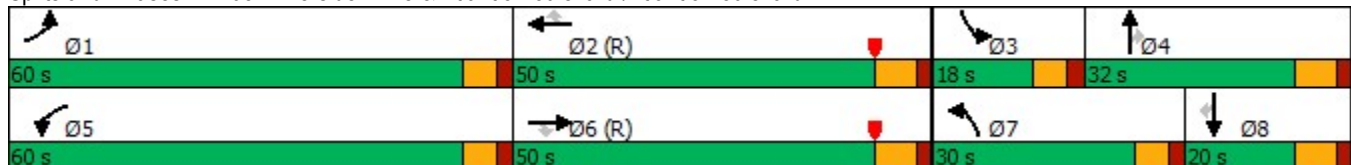







Analysis Period (min) 15

Splits and Phases: 105: Riverside Drive & Atlantic Boulevard /Atlantic Boulevard



Queues

105: Riverside Drive & Atlantic Boulevard /Atlantic Boulevard

												
Lane Group	EBL	EBT	EBR	WBL	WBT	WBR	NBL	NBT	NBR	SBL	SBT	SBR
Lane Group Flow (vph)	112	1071	80	226	809	278	24	686	403	384	479	200
v/c Ratio	0.57	0.41	0.09	0.72	0.29	0.28	0.22	1.24	0.70	1.49	0.60	0.39
Control Delay	84.4	24.8	0.2	72.5	17.6	10.5	79.8	176.9	13.9	288.3	60.4	8.9
Queue Delay	0.0	0.0	0.0	0.0	0.0	0.0	0.0	0.0	0.0	0.0	0.0	0.0
Total Delay	84.4	24.8	0.2	72.5	17.6	10.5	79.8	176.9	13.9	288.3	60.4	8.9
Queue Length 50th (ft)	59	247	0	99	280	179	12	~467	15	~285	247	0
Queue Length 95th (ft)	94	301	0	128	312	284	29	#598	130	#395	316	72
Internal Link Dist (ft)		1763			2560			1528			1193	
Turn Bay Length (ft)	250		300	220		270	300		300	300		300
Base Capacity (vph)	1158	2617	875	1158	2790	980	514	552	573	257	795	510
Starvation Cap Reductn	0	0	0	0	0	0	0	0	0	0	0	0
Spillback Cap Reductn	0	0	0	0	0	0	0	0	0	0	0	0
Storage Cap Reductn	0	0	0	0	0	0	0	0	0	0	0	0
Reduced v/c Ratio	0.10	0.41	0.09	0.20	0.29	0.28	0.05	1.24	0.70	1.49	0.60	0.39

Intersection Summary

~ Volume exceeds capacity, queue is theoretically infinite.









































Queue shown is maximum after two cycles.

95th percentile volume exceeds capacity, queue may be longer.

Queue shown is maximum after two cycles.

HCM 6th Signalized Intersection Summary

105: Riverside Drive & Atlantic Boulevard /Atlantic Boulevard

												
Movement	EBL	EBT	EBR	WBL	WBT	WBR	NBL	NBT	NBR	SBL	SBT	SBR
Lane Configurations	  	  		  	  		  	 	 		  	  
Traffic Volume (veh/h)	101	964	72	203	728	250	22	617	363	346	431	180
Future Volume (veh/h)	101	964	72	203	728	250	22	617	363	346	431	180
Initial Q (Qb), veh	0	0	0	0	0	0	0	0	0	0	0	0
Ped-Bike Adj(A_pbT)	1.00		1.00	1.00		1.00	1.00		1.00	1.00		1.00
Parking Bus, Adj	1.00	1.00	1.00	1.00	1.00	1.00	1.00	1.00	1.00	1.00	1.00	1.00
Work Zone On Approach		No			No			No			No	
Adj Sat Flow, veh/h/ln	1870	1870	1870	1870	1870	1870	1870	1870	1870	1870	1870	1870
Adj Flow Rate, veh/h	112	1071	80	226	809	278	24	686	403	384	479	200
Peak Hour Factor	0.90	0.90	0.90	0.90	0.90	0.90	0.90	0.90	0.90	0.90	0.90	0.90
Percent Heavy Veh, %	2	2	2	2	2	2	2	2	2	2	2	2
Cap, veh/h	155	2695	836	271	2867	889	57	555	248	259	764	341
Arrive On Green	0.06	0.70	0.70	0.10	0.75	0.75	0.02	0.16	0.16	0.08	0.21	0.21
Sat Flow, veh/h	3456	5106	1583	3456	5106	1583	3456	3554	1585	3456	3554	1585
Grp Volume(v), veh/h	112	1071	80	226	809	278	24	686	403	384	479	200
Grp Sat Flow(s),veh/h/ln	1728	1702	1583	1728	1702	1583	1728	1777	1585	1728	1777	1585
Q Serve(g_s), s	5.1	13.9	2.6	10.3	8.1	9.3	1.1	25.0	25.0	12.0	19.6	18.1
Cycle Q Clear(g_c), s	5.1	13.9	2.6	10.3	8.1	9.3	1.1	25.0	25.0	12.0	19.6	18.1
Prop In Lane	1.00		1.00	1.00		1.00	1.00		1.00	1.00		1.00
Lane Grp Cap(c), veh/h	155	2695	836	271	2867	889	57	555	248	259	764	341
V/C Ratio(X)	0.72	0.40	0.10	0.83	0.28	0.31	0.42	1.24	1.63	1.48	0.63	0.59
Avail Cap(c_a), veh/h	1166	2695	836	1166	2867	889	518	555	248	259	764	341
HCM Platoon Ratio	1.33	1.33	1.33	1.33	1.33	1.33	1.00	1.00	1.00	1.00	1.00	1.00
Upstream Filter(I)	1.00	1.00	1.00	0.93	0.93	0.93	1.00	1.00	1.00	1.00	1.00	1.00
Uniform Delay (d), s/veh	74.2	13.3	11.6	70.6	9.9	10.1	77.9	67.5	67.5	74.0	57.0	56.4
Incr Delay (d2), s/veh	2.4	0.4	0.2	2.4	0.2	0.9	1.9	120.9	300.0	236.3	1.2	1.8
Initial Q Delay(d3),s/veh	0.0	0.0	0.0	0.0	0.0	0.0	0.0	0.0	0.0	0.0	0.0	0.0
%ile BackOfQ(50%),veh/ln	2.3	4.8	1.0	4.6	2.9	3.2	0.5	20.7	30.8	13.9	9.0	7.5
Unsig. Movement Delay, s/veh												
LnGrp Delay(d),s/veh	76.6	13.8	11.9	73.1	10.1	10.9	79.8	188.4	367.5	310.3	58.2	58.2
LnGrp LOS	E	B	B	E	B	B	E	F	F	F	E	E
Approach Vol, veh/h		1263			1313			1113			1063	
Approach Delay, s/veh		19.2			21.1			250.9			149.3	
Approach LOS		B			C			F			F	
Timer - Assigned Phs	1	2	3	4	5	6	7	8				
Phs Duration (G+Y+Rc), s	13.2	96.8	18.0	32.0	18.5	91.5	8.6	41.4				
Change Period (Y+Rc), s	6.0	7.0	6.0	7.0	6.0	7.0	6.0	7.0				
Max Green Setting (Gmax), s	54.0	43.0	12.0	25.0	54.0	43.0	24.0	13.0				
Max Q Clear Time (g_c+I1), s	7.1	11.3	14.0	27.0	12.3	15.9	3.1	21.6				
Green Ext Time (p_c), s	0.1	7.8	0.0	0.0	0.3	9.1	0.0	0.0				
Intersection Summary												
HCM 6th Ctrl Delay			103.1									
HCM 6th LOS			F									
Notes												
User approved pedestrian interval to be less than phase max green.												

Timings

106: Ramblewood Drive & Atlantic Boulevard



Lane Group	EBL	EBT	WBL	WBT	NBL	NBT	NBR	SBL	SBT	SBR
Lane Configurations										
Traffic Volume (vph)	59	1554	29	1090	32	22	63	187	11	63
Future Volume (vph)	59	1554	29	1090	32	22	63	187	11	63
Turn Type	pm+pt	NA	pm+pt	NA	Perm	NA	Perm	Perm	NA	Perm
Protected Phases	1	6	5	2		4			8	
Permitted Phases	6		2		4		4	8		8
Detector Phase	1	6	5	2	4	4	4	8	8	8
Switch Phase										
Minimum Initial (s)	4.0	12.0	4.0	12.0	6.0	6.0	6.0	6.0	6.0	6.0
Minimum Split (s)	11.0	45.0	11.0	45.0	36.0	36.0	36.0	36.0	36.0	36.0
Total Split (s)	19.0	91.0	19.0	91.0	50.0	50.0	50.0	50.0	50.0	50.0
Total Split (%)	11.9%	56.9%	11.9%	56.9%	31.3%	31.3%	31.3%	31.3%	31.3%	31.3%
Yellow Time (s)	5.0	5.0	5.0	5.0	4.0	4.0	4.0	4.0	4.0	4.0
All-Red Time (s)	2.0	2.0	2.0	2.0	2.0	2.0	2.0	2.0	2.0	2.0
Lost Time Adjust (s)	0.0	0.0	0.0	0.0	0.0	0.0	0.0	0.0	0.0	0.0
Total Lost Time (s)	7.0	7.0	7.0	7.0	6.0	6.0	6.0	6.0	6.0	6.0
Lead/Lag	Lead	Lag	Lead	Lag						
Lead-Lag Optimize?	Yes	Yes	Yes	Yes						
Recall Mode	None	C-Max	None	C-Max	None	None	None	None	None	None
Act Effct Green (s)	112.8	107.9	109.6	104.7	29.5	29.5	29.5	29.5	29.5	29.5
Actuated g/C Ratio	0.70	0.67	0.68	0.65	0.18	0.18	0.18	0.18	0.18	0.18
v/c Ratio	0.25	0.51	0.18	0.41	0.14	0.04	0.20	0.82	0.03	0.20
Control Delay	4.8	6.1	10.4	13.7	52.5	49.8	9.7	86.3	49.4	9.7
Queue Delay	0.0	0.0	0.0	0.0	0.0	0.0	0.0	0.0	0.0	0.0
Total Delay	4.8	6.1	10.4	13.7	52.5	49.8	9.7	86.3	49.4	9.7
LOS	A	A	B	B	D	D	A	F	D	A
Approach Delay		6.1		13.6		29.0			66.3	
Approach LOS		A		B		C			E	

Intersection Summary

Cycle Length: 160

Actuated Cycle Length: 160

Offset: 83 (52%), Referenced to phase 2:WBTL and 6:EBTL, Start of Yellow

Natural Cycle: 95

Control Type: Actuated-Coordinated

Maximum v/c Ratio: 0.82

Intersection Signal Delay: 14.6

Intersection LOS: B

Intersection Capacity Utilization 69.2%

ICU Level of Service C

Analysis Period (min) 15

Splits and Phases: 106: Ramblewood Drive & Atlantic Boulevard

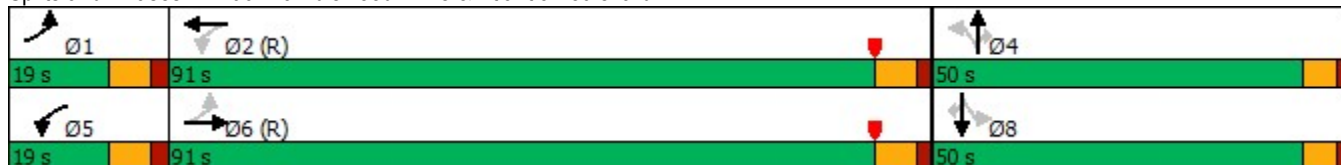

Queues

106: Ramblewood Drive & Atlantic Boulevard

























Lane Group	EBL	EBT	WBL	WBT	NBL	NBT	NBR	SBL	SBT	SBR
Lane Group Flow (vph)	66	1745	32	1337	36	24	70	208	12	70
v/c Ratio	0.25	0.51	0.18	0.41	0.14	0.04	0.20	0.82	0.03	0.20
Control Delay	4.8	6.1	10.4	13.7	52.5	49.8	9.7	86.3	49.4	9.7
Queue Delay	0.0	0.0	0.0	0.0	0.0	0.0	0.0	0.0	0.0	0.0
Total Delay	4.8	6.1	10.4	13.7	52.5	49.8	9.7	86.3	49.4	9.7
Queue Length 50th (ft)	4	54	11	194	32	11	0	212	10	0
Queue Length 95th (ft)	m11	m386	25	212	63	23	39	291	28	39
Internal Link Dist (ft)		2560		3088		436			532	
Turn Bay Length (ft)	180		180		200		425	180		275
Base Capacity (vph)	334	3420	254	3287	383	973	484	379	512	483
Starvation Cap Reductn	0	0	0	0	0	0	0	0	0	0
Spillback Cap Reductn	0	0	0	0	0	0	0	0	0	0
Storage Cap Reductn	0	0	0	0	0	0	0	0	0	0
Reduced v/c Ratio	0.20	0.51	0.13	0.41	0.09	0.02	0.14	0.55	0.02	0.14

Intersection Summary

m Volume for 95th percentile queue is metered by upstream signal.

HCM 6th Signalized Intersection Summary

106: Ramblewood Drive & Atlantic Boulevard

												
Movement	EBL	EBT	EBR	WBL	WBT	WBR	NBL	NBT	NBR	SBL	SBT	SBR
Lane Configurations												
Traffic Volume (veh/h)	59	1554	16	29	1090	113	32	22	63	187	11	63
Future Volume (veh/h)	59	1554	16	29	1090	113	32	22	63	187	11	63
Initial Q (Qb), veh	0	0	0	0	0	0	0	0	0	0	0	0
Ped-Bike Adj(A_pbT)	1.00		0.98	1.00		1.00	1.00		0.98	1.00		1.00
Parking Bus, Adj	1.00	1.00	1.00	1.00	1.00	1.00	1.00	1.00	1.00	1.00	1.00	1.00
Work Zone On Approach		No			No			No			No	
Adj Sat Flow, veh/h/ln	1870	1870	1870	1870	1870	1870	1870	1870	1870	1870	1870	1870
Adj Flow Rate, veh/h	66	1727	18	32	1211	126	36	24	70	208	12	70
Peak Hour Factor	0.90	0.90	0.90	0.90	0.90	0.90	0.90	0.90	0.90	0.90	0.90	0.90
Percent Heavy Veh, %	2	2	2	2	2	2	2	2	2	2	2	2
Cap, veh/h	344	3515	37	248	3148	327	276	644	283	273	339	286
Arrive On Green	0.03	0.90	0.90	0.03	0.89	0.89	0.18	0.18	0.18	0.18	0.18	0.18
Sat Flow, veh/h	1781	5209	54	1781	4698	489	1312	3554	1559	1298	1870	1580
Grp Volume(v), veh/h	66	1129	616	32	877	460	36	24	70	208	12	70
Grp Sat Flow(s),veh/h/ln	1781	1702	1859	1781	1702	1782	1312	1777	1559	1298	1870	1580
Q Serve(g_s), s	1.9	9.7	9.7	0.9	6.8	6.8	3.7	0.9	6.2	25.2	0.8	6.1
Cycle Q Clear(g_c), s	1.9	9.7	9.7	0.9	6.8	6.8	4.6	0.9	6.2	26.1	0.8	6.1
Prop In Lane	1.00		0.03	1.00		0.27	1.00		1.00	1.00		1.00
Lane Grp Cap(c), veh/h	344	2297	1255	248	2281	1194	276	644	283	273	339	286
V/C Ratio(X)	0.19	0.49	0.49	0.13	0.38	0.38	0.13	0.04	0.25	0.76	0.04	0.24
Avail Cap(c_a), veh/h	435	2297	1255	348	2281	1194	399	977	429	395	514	434
HCM Platoon Ratio	1.33	1.33	1.33	1.33	1.33	1.33	1.00	1.00	1.00	1.00	1.00	1.00
Upstream Filter(I)	0.65	0.65	0.65	0.96	0.96	0.96	1.00	1.00	1.00	1.00	1.00	1.00
Uniform Delay (d), s/veh	7.9	3.2	3.2	8.1	3.2	3.2	55.9	54.0	56.2	64.7	54.0	56.1
Incr Delay (d2), s/veh	0.1	0.5	0.9	0.1	0.5	0.9	0.2	0.0	0.5	5.2	0.0	0.4
Initial Q Delay(d3),s/veh	0.0	0.0	0.0	0.0	0.0	0.0	0.0	0.0	0.0	0.0	0.0	0.0
%ile BackOfQ(50%),veh/ln	0.7	2.5	2.8	0.4	2.0	2.2	1.3	0.4	2.5	8.7	0.4	2.5
Unsig. Movement Delay, s/veh												
LnGrp Delay(d),s/veh	8.0	3.7	4.1	8.2	3.7	4.1	56.1	54.0	56.6	69.9	54.0	56.6
LnGrp LOS	A	A	A	A	A	A	E	D	E	E	D	E
Approach Vol, veh/h		1811			1369			130			290	
Approach Delay, s/veh		4.0			4.0			56.0			66.0	
Approach LOS		A			A			E			E	
Timer - Assigned Phs	1	2		4	5	6		8				
Phs Duration (G+Y+Rc), s	10.8	114.2		35.0	10.0	115.0		35.0				
Change Period (Y+Rc), s	7.0	7.0		6.0	7.0	7.0		6.0				
Max Green Setting (Gmax), s	12.0	84.0		44.0	12.0	84.0		44.0				
Max Q Clear Time (g_c+I1), s	3.9	8.8		8.2	2.9	11.7		28.1				
Green Ext Time (p_c), s	0.0	13.8		0.5	0.0	22.3		0.8				
Intersection Summary												
HCM 6th Ctrl Delay				10.8								
HCM 6th LOS				B								

Timings

107: NW 76 Avenue & Atlantic Boulevard



Lane Group	EBL	EBT	WBL	WBT	NBL	NBT	SBL	SBT	SBR
Lane Configurations	↖	↕↕↕↗	↖	↕↕↕↗	↖	↗	↖	↕	↗
Traffic Volume (vph)	61	1817	6	997	34	13	86	24	157
Future Volume (vph)	61	1817	6	997	34	13	86	24	157
Turn Type	Prot	NA	Prot	NA	Perm	NA	Perm	NA	Perm
Protected Phases	1	6	5	2		4		8	
Permitted Phases					4		8		8
Detector Phase	1	6	5	2	4	4	8	8	8
Switch Phase									
Minimum Initial (s)	4.0	12.0	4.0	12.0	6.0	6.0	6.0	6.0	6.0
Minimum Split (s)	24.0	28.0	10.0	28.0	43.0	43.0	43.0	43.0	43.0
Total Split (s)	25.0	100.0	16.0	91.0	44.0	44.0	44.0	44.0	44.0
Total Split (%)	15.6%	62.5%	10.0%	56.9%	27.5%	27.5%	27.5%	27.5%	27.5%
Yellow Time (s)	4.0	4.0	4.0	4.0	4.0	4.0	4.0	4.0	4.0
All-Red Time (s)	2.0	2.0	2.0	2.0	2.0	2.0	2.0	2.0	2.0
Lost Time Adjust (s)	0.0	0.0	0.0	0.0	0.0	0.0	0.0	0.0	0.0
Total Lost Time (s)	6.0	6.0	6.0	6.0	6.0	6.0	6.0	6.0	6.0
Lead/Lag	Lead	Lag	Lead	Lag					
Lead-Lag Optimize?	Yes	Yes	Yes	Yes					
Recall Mode	None	C-Max	None	C-Max	None	None	None	None	None
Act Effct Green (s)	9.7	130.6	4.7	119.6	15.0	15.0	15.0	15.0	15.0
Actuated g/C Ratio	0.06	0.82	0.03	0.75	0.09	0.09	0.09	0.09	0.09
v/c Ratio	0.60	0.47	0.12	0.29	0.27	0.19	0.71	0.14	0.56
Control Delay	93.8	7.3	65.5	6.5	70.4	36.4	97.5	65.8	15.9
Queue Delay	0.0	0.0	0.0	0.0	0.0	0.0	0.0	0.0	0.0
Total Delay	93.8	7.3	65.5	6.5	70.4	36.4	97.5	65.8	15.9
LOS	F	A	E	A	E	D	F	E	B
Approach Delay		10.0		6.8		53.6		46.7	
Approach LOS		B		A		D		D	

Intersection Summary

Cycle Length: 160
 Actuated Cycle Length: 160
 Offset: 138 (86%), Referenced to phase 2:WBT and 6:EBT, Start of Yellow
 Natural Cycle: 95
 Control Type: Actuated-Coordinated
 Maximum v/c Ratio: 0.71
 Intersection Signal Delay: 12.8
 Intersection LOS: B
 Intersection Capacity Utilization 67.4%
 ICU Level of Service C
 Analysis Period (min) 15

Splits and Phases: 107: NW 76 Avenue & Atlantic Boulevard

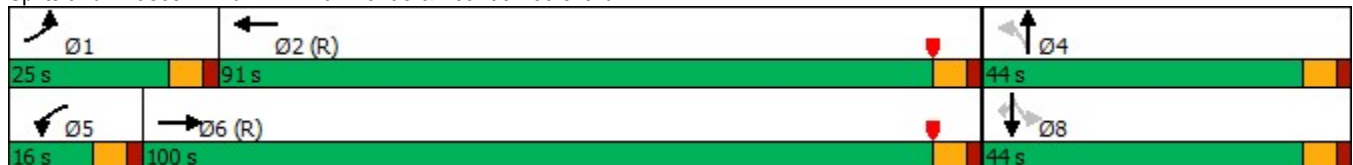

Queues

107: NW 76 Avenue & Atlantic Boulevard



























Lane Group	EBL	EBT	WBL	WBT	NBL	NBT	SBL	SBT	SBR
Lane Group Flow (vph)	64	1951	6	1099	35	34	90	25	164
v/c Ratio	0.60	0.47	0.12	0.29	0.27	0.19	0.71	0.14	0.56
Control Delay	93.8	7.3	65.5	6.5	70.4	36.4	97.5	65.8	15.9
Queue Delay	0.0	0.0	0.0	0.0	0.0	0.0	0.0	0.0	0.0
Total Delay	93.8	7.3	65.5	6.5	70.4	36.4	97.5	65.8	15.9
Queue Length 50th (ft)	67	207	6	120	35	14	93	24	0
Queue Length 95th (ft)	123	265	m12	m147	71	48	152	55	72
Internal Link Dist (ft)		3088		2032		396		487	
Turn Bay Length (ft)	150		200		225		200		200
Base Capacity (vph)	210	4132	110	3766	327	414	323	442	495
Starvation Cap Reductn	0	0	0	0	0	0	0	0	0
Spillback Cap Reductn	0	0	0	0	0	0	0	0	0
Storage Cap Reductn	0	0	0	0	0	0	0	0	0
Reduced v/c Ratio	0.30	0.47	0.05	0.29	0.11	0.08	0.28	0.06	0.33

Intersection Summary

m Volume for 95th percentile queue is metered by upstream signal.

HCM 6th Signalized Intersection Summary

107: NW 76 Avenue & Atlantic Boulevard

												
Movement	EBL	EBT	EBR	WBL	WBT	WBR	NBL	NBT	NBR	SBL	SBT	SBR
Lane Configurations		 			 						 	
Traffic Volume (veh/h)	61	1817	56	6	997	58	34	13	19	86	24	157
Future Volume (veh/h)	61	1817	56	6	997	58	34	13	19	86	24	157
Initial Q (Qb), veh	0	0	0	0	0	0	0	0	0	0	0	0
Ped-Bike Adj(A_pbT)	1.00		1.00	1.00		1.00	1.00		0.98	0.99		0.98
Parking Bus, Adj	1.00	1.00	1.00	1.00	1.00	1.00	1.00	1.00	1.00	1.00	1.00	1.00
Work Zone On Approach		No			No			No			No	
Adj Sat Flow, veh/h/ln	1870	1870	1870	1870	1870	1870	1870	1870	1870	1870	1870	1870
Adj Flow Rate, veh/h	64	1893	58	6	1039	60	35	14	20	90	25	164
Peak Hour Factor	0.96	0.96	0.96	0.96	0.96	0.96	0.96	0.96	0.96	0.96	0.96	0.96
Percent Heavy Veh, %	2	2	2	2	2	2	2	2	2	2	2	2
Cap, veh/h	85	3814	117	10	3492	201	188	91	130	201	247	205
Arrive On Green	0.06	1.00	1.00	0.01	0.94	0.94	0.13	0.13	0.13	0.13	0.13	0.13
Sat Flow, veh/h	1781	5090	156	1781	4938	285	1188	687	982	1366	1870	1553
Grp Volume(v), veh/h	64	1265	686	6	716	383	35	0	34	90	25	164
Grp Sat Flow(s),veh/h/ln	1781	1702	1842	1781	1702	1818	1188	0	1670	1366	1870	1553
Q Serve(g_s), s	5.7	0.4	0.4	0.5	2.8	2.8	4.3	0.0	2.9	10.0	1.9	16.4
Cycle Q Clear(g_c), s	5.7	0.4	0.4	0.5	2.8	2.8	6.2	0.0	2.9	12.9	1.9	16.4
Prop In Lane	1.00		0.08	1.00		0.16	1.00		0.59	1.00		1.00
Lane Grp Cap(c), veh/h	85	2551	1380	10	2407	1286	188	0	221	201	247	205
V/C Ratio(X)	0.75	0.50	0.50	0.58	0.30	0.30	0.19	0.00	0.15	0.45	0.10	0.80
Avail Cap(c_a), veh/h	212	2551	1380	111	2407	1286	313	0	397	345	444	369
HCM Platoon Ratio	1.33	1.33	1.33	1.33	1.33	1.33	1.00	1.00	1.00	1.00	1.00	1.00
Upstream Filter(l)	0.83	0.83	0.83	0.83	0.83	0.83	1.00	0.00	1.00	1.00	1.00	1.00
Uniform Delay (d), s/veh	73.9	0.1	0.1	79.2	1.5	1.5	63.8	0.0	61.5	67.2	61.0	67.3
Incr Delay (d2), s/veh	4.0	0.6	1.1	14.5	0.3	0.5	0.2	0.0	0.1	0.6	0.1	2.7
Initial Q Delay(d3),s/veh	0.0	0.0	0.0	0.0	0.0	0.0	0.0	0.0	0.0	0.0	0.0	0.0
%ile BackOfQ(50%),veh/ln	2.7	0.3	0.5	0.3	0.9	1.0	1.3	0.0	1.2	3.5	0.9	6.7
Unsig. Movement Delay, s/veh												
LnGrp Delay(d),s/veh	78.0	0.6	1.1	93.6	1.7	2.0	63.9	0.0	61.6	67.8	61.1	70.0
LnGrp LOS	E	A	A	F	A	A	E	A	E	E	E	E
Approach Vol, veh/h		2015			1105			69			279	
Approach Delay, s/veh		3.3			2.3			62.8			68.5	
Approach LOS		A			A			E			E	
Timer - Assigned Phs	1	2		4	5	6		8				
Phs Duration (G+Y+Rc), s	13.7	119.2		27.2	6.9	125.9		27.2				
Change Period (Y+Rc), s	6.0	6.0		6.0	6.0	6.0		6.0				
Max Green Setting (Gmax), s	19.0	85.0		38.0	10.0	94.0		38.0				
Max Q Clear Time (g_c+I1), s	7.7	4.8		8.2	2.5	2.4		18.4				
Green Ext Time (p_c), s	0.0	10.0		0.2	0.0	29.7		0.5				
Intersection Summary												
HCM 6th Ctrl Delay				9.4								
HCM 6th LOS				A								

Timings

108: Rock Island Road & Atlantic Boulevard/Atlantic Boulevard



Lane Group	EBL	EBT	WBL	WBT	NBL	NBT	NBR	SBL	SBT
Lane Configurations									
Traffic Volume (vph)	146	1297	277	713	281	923	470	184	867
Future Volume (vph)	146	1297	277	713	281	923	470	184	867
Turn Type	Prot	NA	Prot	NA	Prot	NA	Perm	Prot	NA
Protected Phases	1	6	5	2	7	4		3	8
Permitted Phases							4		
Detector Phase	1	6	5	2	7	4	4	3	8
Switch Phase									
Minimum Initial (s)	5.0	12.0	5.0	12.0	5.0	6.0	6.0	5.0	6.0
Minimum Split (s)	11.0	49.0	11.0	49.0	11.5	51.5	51.5	11.5	51.5
Total Split (s)	26.0	58.0	26.0	58.0	24.0	52.0	52.0	24.0	52.0
Total Split (%)	16.3%	36.3%	16.3%	36.3%	15.0%	32.5%	32.5%	15.0%	32.5%
Yellow Time (s)	4.0	4.0	4.0	4.0	4.5	4.5	4.5	4.5	4.5
All-Red Time (s)	2.0	2.0	2.0	2.0	2.0	2.0	2.0	2.0	2.0
Lost Time Adjust (s)	0.0	0.0	0.0	0.0	0.0	0.0	0.0	0.0	0.0
Total Lost Time (s)	6.0	6.0	6.0	6.0	6.5	6.5	6.5	6.5	6.5
Lead/Lag	Lead	Lag	Lead	Lag	Lead	Lag	Lag	Lead	Lag
Lead-Lag Optimize?	Yes	Yes	Yes	Yes	Yes	Yes	Yes	Yes	Yes
Recall Mode	None	C-Max	None	C-Max	None	None	None	None	None
Act Effct Green (s)	10.9	55.2	16.8	61.1	16.2	50.3	50.3	12.7	46.8
Actuated g/C Ratio	0.07	0.34	0.10	0.38	0.10	0.31	0.31	0.08	0.29
v/c Ratio	0.65	0.94	0.79	0.43	0.84	0.86	0.85	0.70	0.99
Control Delay	90.5	69.5	66.9	67.8	79.0	45.0	36.9	64.6	82.2
Queue Delay	0.0	0.0	0.0	0.0	0.0	0.0	0.0	0.0	0.0
Total Delay	90.5	69.5	66.9	67.8	79.0	45.0	36.9	64.6	82.2
LOS	F	E	E	E	E	D	D	E	F
Approach Delay		71.3		67.6		48.4			79.4
Approach LOS		E		E		D			E

Intersection Summary

Cycle Length: 160
 Actuated Cycle Length: 160
 Offset: 100 (63%), Referenced to phase 2:WBT and 6:EBT, Start of Yellow
 Natural Cycle: 135
 Control Type: Actuated-Coordinated
 Maximum v/c Ratio: 0.99
 Intersection Signal Delay: 65.5
 Intersection LOS: E
 Intersection Capacity Utilization 100.6%
 ICU Level of Service G
 Analysis Period (min) 15

Splits and Phases: 108: Rock Island Road & Atlantic Boulevard/Atlantic Boulevard

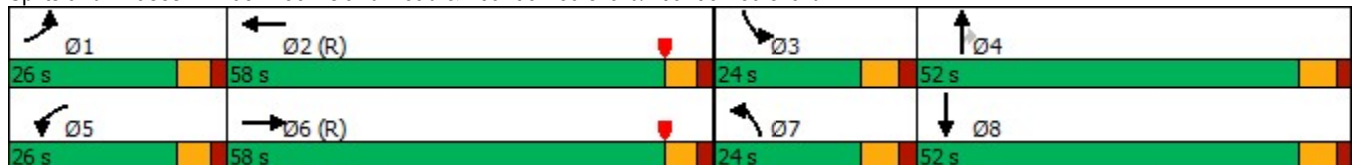

Queues

108: Rock Island Road & Atlantic Boulevard/Atlantic Boulevard



Lane Group	EBL	EBT	WBL	WBT	NBL	NBT	NBR	SBL	SBT
Lane Group Flow (vph)	151	1619	286	825	290	952	485	190	1014
v/c Ratio	0.65	0.94	0.79	0.43	0.84	0.86	0.85	0.70	0.99
Control Delay	90.5	69.5	66.9	67.8	79.0	45.0	36.9	64.6	82.2
Queue Delay	0.0	0.0	0.0	0.0	0.0	0.0	0.0	0.0	0.0
Total Delay	90.5	69.5	66.9	67.8	79.0	45.0	36.9	64.6	82.2
Queue Length 50th (ft)	86	477	158	316	161	520	413	98	~596
Queue Length 95th (ft)	125	#531	m184	m368	m180	m538	m456	m136	#738
Internal Link Dist (ft)		2032		5200		2618			3616
Turn Bay Length (ft)	300		300		210		23	200	
Base Capacity (vph)	429	1725	429	1915	375	1111	570	375	1021
Starvation Cap Reductn	0	0	0	0	0	0	0	0	0
Spillback Cap Reductn	0	0	0	0	0	0	0	0	0
Storage Cap Reductn	0	0	0	0	0	0	0	0	0
Reduced v/c Ratio	0.35	0.94	0.67	0.43	0.77	0.86	0.85	0.51	0.99

Intersection Summary

~ Volume exceeds capacity, queue is theoretically infinite.

Queue shown is maximum after two cycles.



























95th percentile volume exceeds capacity, queue may be longer.

Queue shown is maximum after two cycles.

m Volume for 95th percentile queue is metered by upstream signal.

HCM 6th Signalized Intersection Summary

108: Rock Island Road & Atlantic Boulevard/Atlantic Boulevard

												
Movement	EBL	EBT	EBR	WBL	WBT	WBR	NBL	NBT	NBR	SBL	SBT	SBR
Lane Configurations	 	 		 	 		 	 	 			
Traffic Volume (veh/h)	146	1297	274	277	713	87	281	923	470	184	867	116
Future Volume (veh/h)	146	1297	274	277	713	87	281	923	470	184	867	116
Initial Q (Qb), veh	0	0	0	0	0	0	0	0	0	0	0	0
Ped-Bike Adj(A_pbT)	1.00		0.99	1.00		1.00	1.00		1.00	1.00		0.99
Parking Bus, Adj	1.00	1.00	1.00	1.00	1.00	1.00	1.00	1.00	1.00	1.00	1.00	1.00
Work Zone On Approach		No			No			No			No	
Adj Sat Flow, veh/h/ln	1870	1870	1870	1870	1870	1870	1870	1870	1870	1870	1870	1870
Adj Flow Rate, veh/h	151	1337	282	286	735	90	290	952	485	190	894	120
Peak Hour Factor	0.97	0.97	0.97	0.97	0.97	0.97	0.97	0.97	0.97	0.97	0.97	0.97
Percent Heavy Veh, %	2	2	2	2	2	2	2	2	2	2	2	2
Cap, veh/h	194	1549	326	328	1875	228	334	1114	496	233	894	120
Arrive On Green	0.07	0.49	0.49	0.13	0.54	0.54	0.03	0.10	0.10	0.07	0.28	0.28
Sat Flow, veh/h	3456	4212	888	3456	4612	560	3456	3554	1584	3456	3142	422
Grp Volume(v), veh/h	151	1080	539	286	541	284	290	952	485	190	506	508
Grp Sat Flow(s),veh/h/ln	1728	1702	1696	1728	1702	1769	1728	1777	1584	1728	1777	1787
Q Serve(g_s), s	6.9	44.9	45.0	13.0	14.8	15.0	13.4	42.2	48.9	8.7	45.5	45.5
Cycle Q Clear(g_c), s	6.9	44.9	45.0	13.0	14.8	15.0	13.4	42.2	48.9	8.7	45.5	45.5
Prop In Lane	1.00		0.52	1.00		0.32	1.00		1.00	1.00		0.24
Lane Grp Cap(c), veh/h	194	1252	624	328	1384	719	334	1114	496	233	505	508
V/C Ratio(X)	0.78	0.86	0.86	0.87	0.39	0.39	0.87	0.85	0.98	0.81	1.00	1.00
Avail Cap(c_a), veh/h	432	1252	624	432	1384	719	378	1114	496	378	505	508
HCM Platoon Ratio	1.33	1.33	1.33	1.33	1.33	1.33	0.33	0.33	0.33	1.00	1.00	1.00
Upstream Filter(l)	0.87	0.87	0.87	0.36	0.36	0.36	0.12	0.12	0.12	0.90	0.90	0.90
Uniform Delay (d), s/veh	73.0	37.3	37.3	68.9	25.2	25.2	76.4	68.1	71.1	73.6	57.3	57.3
Incr Delay (d2), s/veh	2.2	7.1	13.1	4.7	0.3	0.6	2.3	0.8	9.3	2.5	38.1	38.0
Initial Q Delay(d3),s/veh	0.0	0.0	0.0	0.0	0.0	0.0	0.0	0.0	0.0	0.0	0.0	0.0
%ile BackOfQ(50%),veh/ln	3.1	18.9	19.9	5.8	5.7	6.1	6.4	20.4	22.3	4.0	25.8	25.9
Unsig. Movement Delay, s/veh												
LnGrp Delay(d),s/veh	75.3	44.4	50.4	73.7	25.5	25.8	78.8	69.0	80.5	76.1	95.3	95.3
LnGrp LOS	E	D	D	E	C	C	E	E	F	E	F	F
Approach Vol, veh/h		1770			1111			1727			1204	
Approach Delay, s/veh		48.8			38.0			73.8			92.3	
Approach LOS		D			D			E			F	
Timer - Assigned Phs	1	2	3	4	5	6	7	8				
Phs Duration (G+Y+Rc), s	15.0	71.1	17.3	56.7	21.2	64.8	22.0	52.0				
Change Period (Y+Rc), s	6.0	6.0	6.5	6.5	6.0	6.0	6.5	6.5				
Max Green Setting (Gmax), s	20.0	52.0	17.5	45.5	20.0	52.0	17.5	45.5				
Max Q Clear Time (g_c+I1), s	8.9	17.0	10.7	50.9	15.0	47.0	15.4	47.5				
Green Ext Time (p_c), s	0.1	6.4	0.1	0.0	0.2	3.9	0.1	0.0				
Intersection Summary												
HCM 6th Ctrl Delay				63.2								
HCM 6th LOS				E								

Timings

109: SR 7 & Atlantic Boulevard

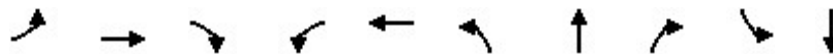

Lane Group	EBL	EBT	EBR	WBL	WBT	NBL	NBT	NBR	SBL	SBT
Lane Configurations	↔↔	↑↑↑	↗	↔↔	↑↑↑	↗	↑↑↑	↗	↗	↑↑↑
Traffic Volume (vph)	474	1392	188	296	784	119	1629	542	272	1288
Future Volume (vph)	474	1392	188	296	784	119	1629	542	272	1288
Turn Type	Prot	NA	Perm	Prot	NA	Prot	NA	Perm	Prot	NA
Protected Phases	7	4		3	8	5	2		1	6
Permitted Phases			4					2		
Detector Phase	7	4	4	3	8	5	2	2	1	6
Switch Phase										
Minimum Initial (s)	4.0	6.0	6.0	4.0	6.0	5.0	8.0	8.0	5.0	8.0
Minimum Split (s)	11.0	47.0	47.0	11.0	43.0	12.0	50.0	50.0	12.0	50.0
Total Split (s)	31.0	53.0	53.0	21.0	43.0	19.0	57.0	57.0	29.0	67.0
Total Split (%)	19.4%	33.1%	33.1%	13.1%	26.9%	11.9%	35.6%	35.6%	18.1%	41.9%
Yellow Time (s)	5.0	5.0	5.0	5.0	5.0	5.0	5.0	5.0	5.0	5.0
All-Red Time (s)	2.0	2.0	2.0	2.0	2.0	2.0	2.0	2.0	2.0	2.0
Lost Time Adjust (s)	0.0	0.0	0.0	0.0	0.0	0.0	0.0	0.0	0.0	0.0
Total Lost Time (s)	7.0	7.0	7.0	7.0	7.0	7.0	7.0	7.0	7.0	7.0
Lead/Lag	Lead	Lag	Lag	Lead	Lag	Lead	Lag	Lag	Lead	Lag
Lead-Lag Optimize?	Yes	Yes	Yes	Yes	Yes	Yes	Yes	Yes	Yes	Yes
Recall Mode	None	None	None	None	None	None	C-Max	C-Max	None	C-Max
Act Effct Green (s)	23.8	46.0	46.0	14.0	36.2	12.0	50.0	50.0	22.0	60.0
Actuated g/C Ratio	0.15	0.29	0.29	0.09	0.23	0.08	0.31	0.31	0.14	0.38
v/c Ratio	0.96	0.98	0.34	1.02	0.87	0.93	1.06	0.86	1.15	0.79
Control Delay	100.4	74.0	18.3	126.2	67.0	133.4	91.2	42.6	167.4	47.0
Queue Delay	0.0	0.0	0.0	0.0	0.0	0.0	0.0	0.0	0.0	0.0
Total Delay	100.4	74.0	18.3	126.2	67.0	133.4	91.2	42.6	167.4	47.0
LOS	F	E	B	F	E	F	F	D	F	D
Approach Delay		75.0			81.0		81.9			66.0
Approach LOS		E			F		F			E

Intersection Summary

Cycle Length: 160

Actuated Cycle Length: 160

Offset: 115 (72%), Referenced to phase 2:NBT and 6:SBT, Start of Yellow

Natural Cycle: 150

Control Type: Actuated-Coordinated

Maximum v/c Ratio: 1.15

Intersection Signal Delay: 76.1

Intersection LOS: E

Intersection Capacity Utilization 109.8%

ICU Level of Service H

Analysis Period (min) 15

Splits and Phases: 109: SR 7 & Atlantic Boulevard

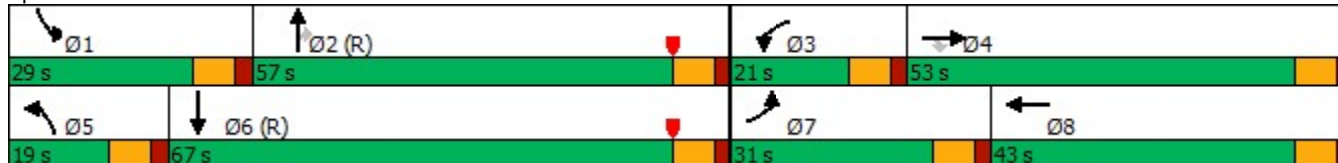

Queues

109: SR 7 & Atlantic Boulevard

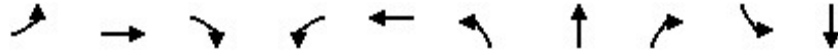

Lane Group	EBL	EBT	EBR	WBL	WBT	NBL	NBT	NBR	SBL	SBT
Lane Group Flow (vph)	489	1435	194	305	986	123	1679	559	280	1491
v/c Ratio	0.96	0.98	0.34	1.02	0.87	0.93	1.06	0.86	1.15	0.79
Control Delay	100.4	74.0	18.3	126.2	67.0	133.4	91.2	42.6	167.4	47.0
Queue Delay	0.0	0.0	0.0	0.0	0.0	0.0	0.0	0.0	0.0	0.0
Total Delay	100.4	74.0	18.3	126.2	67.0	133.4	91.2	42.6	167.4	47.0
Queue Length 50th (ft)	278	467	35	~173	358	130	~702	342	~351	307
Queue Length 95th (ft)	m#327	m#627	m58	#275	417	#266	#797	#558	#551	462
Internal Link Dist (ft)		5200			1156		610			2153
Turn Bay Length (ft)	275		350	520		400		260	400	
Base Capacity (vph)	514	1461	572	300	1137	132	1589	653	243	1881
Starvation Cap Reductn	0	0	0	0	0	0	0	0	0	0
Spillback Cap Reductn	0	0	0	0	0	0	0	0	0	0
Storage Cap Reductn	0	0	0	0	0	0	0	0	0	0
Reduced v/c Ratio	0.95	0.98	0.34	1.02	0.87	0.93	1.06	0.86	1.15	0.79

Intersection Summary

~ Volume exceeds capacity, queue is theoretically infinite.

Queue shown is maximum after two cycles.

95th percentile volume exceeds capacity, queue may be longer.

Queue shown is maximum after two cycles.

m Volume for 95th percentile queue is metered by upstream signal.

HCM 6th Signalized Intersection Summary

109: SR 7 & Atlantic Boulevard



Movement	EBL	EBT	EBR	WBL	WBT	WBR	NBL	NBT	NBR	SBL	SBT	SBR
Lane Configurations	↔↔	↑↑↑	↗	↔↔	↑↑↑		↗	↑↑↑	↗	↗	↑↑↑	
Traffic Volume (veh/h)	474	1392	188	296	784	173	119	1629	542	272	1288	158
Future Volume (veh/h)	474	1392	188	296	784	173	119	1629	542	272	1288	158
Initial Q (Qb), veh	0	0	0	0	0	0	0	0	0	0	0	0
Ped-Bike Adj(A_pbT)	1.00		1.00	1.00		1.00	1.00		0.99	1.00		0.99
Parking Bus, Adj	1.00	1.00	1.00	1.00	1.00	1.00	1.00	1.00	1.00	1.00	1.00	1.00
Work Zone On Approach		No			No			No			No	
Adj Sat Flow, veh/h/ln	1870	1870	1870	1870	1870	1870	1870	1870	1870	1870	1870	1870
Adj Flow Rate, veh/h	489	1435	194	305	808	178	123	1679	559	280	1328	163
Peak Hour Factor	0.97	0.97	0.97	0.97	0.97	0.97	0.97	0.97	0.97	0.97	0.97	0.97
Percent Heavy Veh, %	2	2	2	2	2	2	2	2	2	2	2	2
Cap, veh/h	518	1468	454	302	943	206	134	1596	492	245	1726	212
Arrive On Green	0.15	0.29	0.29	0.09	0.22	0.22	0.10	0.42	0.42	0.18	0.50	0.50
Sat Flow, veh/h	3456	5106	1580	3456	4189	916	1781	5106	1574	1781	4604	565
Grp Volume(v), veh/h	489	1435	194	305	655	331	123	1679	559	280	982	509
Grp Sat Flow(s),veh/h/ln	1728	1702	1580	1728	1702	1701	1781	1702	1574	1781	1702	1765
Q Serve(g_s), s	22.4	44.6	16.0	14.0	29.6	29.9	11.0	50.0	50.0	22.0	37.5	37.5
Cycle Q Clear(g_c), s	22.4	44.6	16.0	14.0	29.6	29.9	11.0	50.0	50.0	22.0	37.5	37.5
Prop In Lane	1.00		1.00	1.00		0.54	1.00		1.00	1.00		0.32
Lane Grp Cap(c), veh/h	518	1468	454	302	766	383	134	1596	492	245	1277	662
V/C Ratio(X)	0.94	0.98	0.43	1.01	0.86	0.86	0.92	1.05	1.14	1.14	0.77	0.77
Avail Cap(c_a), veh/h	518	1468	454	302	766	383	134	1596	492	245	1277	662
HCM Platoon Ratio	1.00	1.00	1.00	1.00	1.00	1.00	1.33	1.33	1.33	1.33	1.33	1.33
Upstream Filter(l)	0.31	0.31	0.31	1.00	1.00	1.00	1.00	1.00	1.00	0.81	0.81	0.81
Uniform Delay (d), s/veh	67.3	56.5	46.3	73.0	59.5	59.6	71.5	46.8	46.8	65.4	34.5	34.5
Incr Delay (d2), s/veh	11.2	8.6	0.1	54.0	9.2	17.8	53.5	37.7	83.6	96.3	3.7	6.9
Initial Q Delay(d3),s/veh	0.0	0.0	0.0	0.0	0.0	0.0	0.0	0.0	0.0	0.0	0.0	0.0
%ile BackOfQ(50%),veh/ln	10.7	20.3	6.4	8.5	13.8	14.8	6.9	25.7	30.1	16.3	15.3	16.5
Unsig. Movement Delay, s/veh												
LnGrp Delay(d),s/veh	78.5	65.1	46.4	127.0	68.7	77.5	125.0	84.4	130.4	161.6	38.1	41.4
LnGrp LOS	E	E	D	F	E	E	F	F	F	F	D	D
Approach Vol, veh/h		2118			1291			2361			1771	
Approach Delay, s/veh		66.5			84.7			97.4			58.6	
Approach LOS		E			F			F			E	
Timer - Assigned Phs	1	2	3	4	5	6	7	8				
Phs Duration (G+Y+Rc), s	29.0	57.0	21.0	53.0	19.0	67.0	31.0	43.0				
Change Period (Y+Rc), s	7.0	7.0	7.0	7.0	7.0	7.0	7.0	7.0				
Max Green Setting (Gmax), s	22.0	50.0	14.0	46.0	12.0	60.0	24.0	36.0				
Max Q Clear Time (g_c+I1), s	24.0	52.0	16.0	46.6	13.0	39.5	24.4	31.9				
Green Ext Time (p_c), s	0.0	0.0	0.0	0.0	0.0	10.9	0.0	2.1				

Intersection Summary

HCM 6th Ctrl Delay	77.4
HCM 6th LOS	E

Notes

User approved pedestrian interval to be less than phase max green.

Timings

110: Southgate Boulevard & Rock Island Road

Lane Group	EBL	EBT	EBR	WBL	WBT	NBL	NBT	NBR	SBL	SBT	SBR	
Lane Configurations												
Traffic Volume (vph)	553	720	167	38	483	169	960	112	286	862	439	
Future Volume (vph)	553	720	167	38	483	169	960	112	286	862	439	
Turn Type	Prot	NA	Perm	Prot	NA	pm+pt	NA	Perm	pm+pt	NA	Perm	
Protected Phases	7	4		3	8	5	2		1	6		
Permitted Phases			4			2		2	6		6	
Detector Phase	7	4	4	3	8	5	2	2	1	6	6	
Switch Phase												
Minimum Initial (s)	5.0	6.0	6.0	5.0	6.0	4.0	12.0	12.0	4.0	12.0	12.0	
Minimum Split (s)	11.5	36.5	36.5	11.5	47.5	10.5	44.5	44.5	10.5	44.5	44.5	
Total Split (s)	26.0	49.0	49.0	26.0	49.0	19.0	66.0	66.0	19.0	66.0	66.0	
Total Split (%)	16.3%	30.6%	30.6%	16.3%	30.6%	11.9%	41.3%	41.3%	11.9%	41.3%	41.3%	
Yellow Time (s)	4.5	4.5	4.5	4.5	4.5	4.5	4.5	4.5	4.5	4.5	4.5	
All-Red Time (s)	2.0	2.0	2.0	2.0	2.0	2.0	2.0	2.0	2.0	2.0	2.0	
Lost Time Adjust (s)	0.0	0.0	0.0	0.0	0.0	0.0	0.0	0.0	0.0	0.0	0.0	
Total Lost Time (s)	6.5	6.5	6.5	6.5	6.5	6.5	6.5	6.5	6.5	6.5	6.5	
Lead/Lag	Lead	Lag	Lag	Lead	Lag	Lead	Lag	Lag	Lead	Lag	Lag	
Lead-Lag Optimize?	Yes	Yes	Yes	Yes	Yes	Yes	Yes	Yes	Yes	Yes	Yes	
Recall Mode	None	None	None	None	None	None	C-Max	C-Max	None	C-Max	C-Max	
Act Effct Green (s)	19.5	53.7	53.7	7.7	39.7	70.9	59.5	59.5	77.3	63.4	63.4	
Actuated g/C Ratio	0.12	0.34	0.34	0.05	0.25	0.44	0.37	0.37	0.48	0.40	0.40	
v/c Ratio	1.38	0.63	0.29	0.47	0.91	0.70	0.76	0.18	1.22	0.64	0.58	
Control Delay	233.5	48.1	16.0	91.2	68.1	38.1	48.6	6.7	161.3	43.4	21.7	
Queue Delay	0.0	0.0	0.0	0.0	0.0	0.0	0.0	0.0	0.0	0.0	0.0	
Total Delay	233.5	48.1	16.0	91.2	68.1	38.1	48.6	6.7	161.3	43.4	21.7	
LOS	F	D	B	F	E	D	D	A	F	D	C	
Approach Delay		115.5			69.2		43.4			58.7		
Approach LOS		F			E		D			E		

Intersection Summary

Cycle Length: 160	
Actuated Cycle Length: 160	
Offset: 60 (38%), Referenced to phase 2:NBTL and 6:SBTL, Start of Yellow	
Natural Cycle: 145	
Control Type: Actuated-Coordinated	
Maximum v/c Ratio: 1.38	
Intersection Signal Delay: 72.7	Intersection LOS: E
Intersection Capacity Utilization 108.0%	ICU Level of Service G
Analysis Period (min) 15	

Splits and Phases: 110: Southgate Boulevard & Rock Island Road

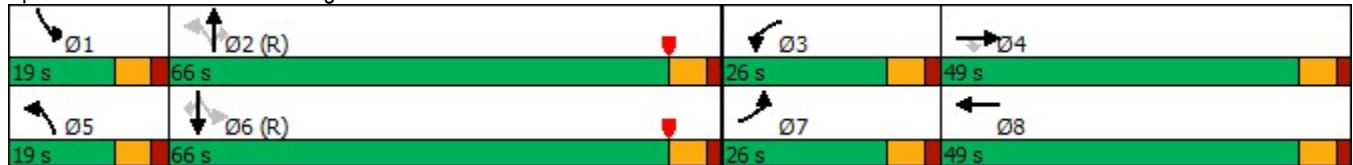

Queues

110: Southgate Boulevard & Rock Island Road



Lane Group	EBL	EBT	EBR	WBL	WBT	NBL	NBT	NBR	SBL	SBT	SBR
Lane Group Flow (vph)	576	750	174	40	806	176	1000	117	298	898	457
v/c Ratio	1.38	0.63	0.29	0.47	0.91	0.70	0.76	0.18	1.22	0.64	0.58
Control Delay	233.5	48.1	16.0	91.2	68.1	38.1	48.6	6.7	161.3	43.4	21.7
Queue Delay	0.0	0.0	0.0	0.0	0.0	0.0	0.0	0.0	0.0	0.0	0.0
Total Delay	233.5	48.1	16.0	91.2	68.1	38.1	48.6	6.7	161.3	43.4	21.7
Queue Length 50th (ft)	~409	347	45	42	391	102	481	3	~334	331	137
Queue Length 95th (ft)	#534	433	111	83	476	154	567	47	m#409	m349	m153
Internal Link Dist (ft)		387			374		435			2618	
Turn Bay Length (ft)	310		140	220		230			170		170
Base Capacity (vph)	418	1188	595	215	939	266	1316	650	245	1402	790
Starvation Cap Reductn	0	0	0	0	0	0	0	0	0	0	0
Spillback Cap Reductn	0	0	0	0	0	0	0	0	0	0	0
Storage Cap Reductn	0	0	0	0	0	0	0	0	0	0	0
Reduced v/c Ratio	1.38	0.63	0.29	0.19	0.86	0.66	0.76	0.18	1.22	0.64	0.58

Intersection Summary

~ Volume exceeds capacity, queue is theoretically infinite.

Queue shown is maximum after two cycles.

95th percentile volume exceeds capacity, queue may be longer.

Queue shown is maximum after two cycles.

m Volume for 95th percentile queue is metered by upstream signal.

HCM 6th Signalized Intersection Summary
 110: Southgate Boulevard & Rock Island Road

Movement	EBL	EBT	EBR	WBL	WBT	WBR	NBL	NBT	NBR	SBL	SBT	SBR
Lane Configurations												
Traffic Volume (veh/h)	553	720	167	38	483	291	169	960	112	286	862	439
Future Volume (veh/h)	553	720	167	38	483	291	169	960	112	286	862	439
Initial Q (Qb), veh	0	0	0	0	0	0	0	0	0	0	0	0
Ped-Bike Adj(A_pbT)	1.00		1.00	1.00		0.99	1.00		1.00	1.00		1.00
Parking Bus, Adj	1.00	1.00	1.00	1.00	1.00	1.00	1.00	1.00	1.00	1.00	1.00	1.00
Work Zone On Approach		No			No			No			No	
Adj Sat Flow, veh/h/ln	1870	1870	1870	1870	1870	1870	1870	1870	1870	1870	1870	1870
Adj Flow Rate, veh/h	576	750	174	40	503	303	176	1000	0	298	898	457
Peak Hour Factor	0.96	0.96	0.96	0.96	0.96	0.96	0.96	0.96	0.96	0.96	0.96	0.96
Percent Heavy Veh, %	2	2	2	2	2	2	2	2	2	2	2	2
Cap, veh/h	421	1230	546	52	539	324	258	1366		277	1385	617
Arrive On Green	0.12	0.35	0.35	0.03	0.25	0.25	0.10	0.51	0.00	0.10	0.52	0.52
Sat Flow, veh/h	3456	3554	1578	1781	2129	1279	1781	3554	1585	1781	3554	1583
Grp Volume(v), veh/h	576	750	174	40	419	387	176	1000	0	298	898	457
Grp Sat Flow(s),veh/h/ln	1728	1777	1578	1781	1777	1631	1781	1777	1585	1781	1777	1583
Q Serve(g_s), s	19.5	28.0	13.0	3.6	36.9	37.1	9.6	35.2	0.0	12.5	29.3	36.1
Cycle Q Clear(g_c), s	19.5	28.0	13.0	3.6	36.9	37.1	9.6	35.2	0.0	12.5	29.3	36.1
Prop In Lane	1.00		1.00	1.00		0.78	1.00		1.00	1.00		1.00
Lane Grp Cap(c), veh/h	421	1230	546	52	450	413	258	1366		277	1385	617
V/C Ratio(X)	1.37	0.61	0.32	0.77	0.93	0.94	0.68	0.73		1.08	0.65	0.74
Avail Cap(c_a), veh/h	421	1230	546	217	472	433	267	1366		277	1385	617
HCM Platoon Ratio	1.00	1.00	1.00	1.00	1.00	1.00	1.33	1.33	1.33	1.33	1.33	1.33
Upstream Filter(I)	1.00	1.00	1.00	1.00	1.00	1.00	1.00	1.00	0.00	0.21	0.21	0.21
Uniform Delay (d), s/veh	70.3	43.4	38.5	77.2	58.4	58.5	29.8	32.7	0.0	41.2	30.6	32.2
Incr Delay (d2), s/veh	180.0	0.6	0.1	8.8	24.4	26.6	5.4	3.5	0.0	48.1	0.5	1.7
Initial Q Delay(d3),s/veh	0.0	0.0	0.0	0.0	0.0	0.0	0.0	0.0	0.0	0.0	0.0	0.0
%ile BackOfQ(50%),veh/ln	19.2	12.6	5.1	1.8	19.7	18.4	4.4	15.0	0.0	9.0	12.0	13.3
Unsig. Movement Delay, s/veh												
LnGrp Delay(d),s/veh	250.3	44.0	38.6	86.0	82.8	85.1	35.2	36.2	0.0	89.3	31.1	33.9
LnGrp LOS	F	D	D	F	F	F	D	D		F	C	C
Approach Vol, veh/h		1500			846			1176			1653	
Approach Delay, s/veh		122.6			84.0			36.0			42.4	
Approach LOS		F			F			D			D	
Timer - Assigned Phs	1	2	3	4	5	6	7	8				
Phs Duration (G+Y+Rc), s	19.0	68.0	11.1	61.9	18.1	68.9	26.0	47.0				
Change Period (Y+Rc), s	6.5	6.5	6.5	6.5	6.5	6.5	6.5	6.5				
Max Green Setting (Gmax), s	12.5	59.5	19.5	42.5	12.5	59.5	19.5	42.5				
Max Q Clear Time (g_c+I1), s	14.5	37.2	5.6	30.0	11.6	38.1	21.5	39.1				
Green Ext Time (p_c), s	0.0	7.7	0.0	3.3	0.0	8.6	0.0	1.3				
Intersection Summary												
HCM 6th Ctrl Delay				71.0								
HCM 6th LOS				E								
Notes												
Unsignalized Delay for [NBR] is excluded from calculations of the approach delay and intersection delay.												

Timings

111: NW 66 Avenue & Atlantic Boulevard

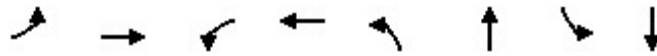

Lane Group	EBL	EBT	WBL	WBT	NBL	NBT	SBL	SBT
Lane Configurations	↶	↶↶↶	↶	↶↶↶	↶	↶	↶	↶
Traffic Volume (vph)	148	1789	17	831	66	24	126	19
Future Volume (vph)	148	1789	17	831	66	24	126	19
Turn Type	pm+pt	NA	pm+pt	NA	Perm	NA	Perm	NA
Protected Phases	1	6	5	2		4		8
Permitted Phases	6		2		4		8	
Detector Phase	1	6	5	2	4	4	8	8
Switch Phase								
Minimum Initial (s)	4.0	10.0	4.0	10.0	6.0	6.0	6.0	6.0
Minimum Split (s)	12.0	50.0	12.0	50.0	45.0	45.0	45.0	45.0
Total Split (s)	25.0	87.0	25.0	87.0	48.0	48.0	48.0	48.0
Total Split (%)	15.6%	54.4%	15.6%	54.4%	30.0%	30.0%	30.0%	30.0%
Yellow Time (s)	4.0	4.0	4.0	4.0	4.0	4.0	4.0	4.0
All-Red Time (s)	2.0	2.0	2.0	2.0	2.0	2.0	2.0	2.0
Lost Time Adjust (s)	0.0	0.0	0.0	0.0	0.0	0.0	0.0	0.0
Total Lost Time (s)	6.0	6.0	6.0	6.0	6.0	6.0	6.0	6.0
Lead/Lag	Lead	Lag	Lead	Lag				
Lead-Lag Optimize?	Yes	Yes	Yes	Yes				
Recall Mode	None	C-Max	None	C-Max	None	None	None	None
Act Effct Green (s)	125.7	120.4	117.6	113.2	21.2	21.2	21.2	21.2
Actuated g/C Ratio	0.79	0.75	0.74	0.71	0.13	0.13	0.13	0.13
v/c Ratio	0.37	0.52	0.11	0.28	0.58	0.29	0.79	0.43
Control Delay	7.0	9.8	6.6	9.3	82.0	26.9	96.0	18.3
Queue Delay	0.0	0.0	0.0	0.0	0.0	0.0	0.0	0.0
Total Delay	7.0	9.8	6.6	9.3	82.0	26.9	96.0	18.3
LOS	A	A	A	A	F	C	F	B
Approach Delay		9.6		9.3		53.9		57.6
Approach LOS		A		A		D		E

Intersection Summary

Cycle Length: 160

Actuated Cycle Length: 160

Offset: 50 (31%), Referenced to phase 2:WBTL and 6:EBTL, Start of Yellow

Natural Cycle: 110

Control Type: Actuated-Coordinated

Maximum v/c Ratio: 0.79

Intersection Signal Delay: 15.0

Intersection LOS: B

Intersection Capacity Utilization 76.0%

ICU Level of Service D

Analysis Period (min) 15

Splits and Phases: 111: NW 66 Avenue & Atlantic Boulevard

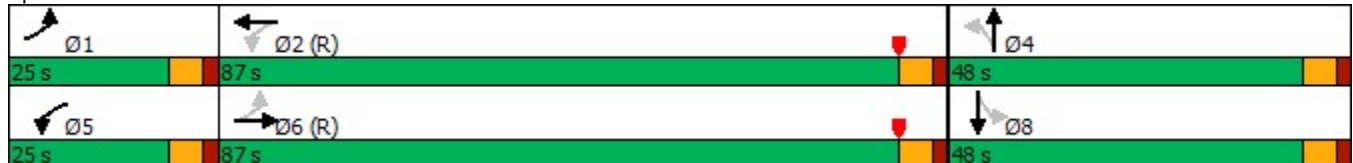

Queues

111: NW 66 Avenue & Atlantic Boulevard

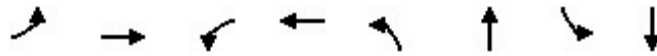

Lane Group	EBL	EBT	WBL	WBT	NBL	NBT	SBL	SBT
Lane Group Flow (vph)	161	1979	18	991	72	75	137	134
v/c Ratio	0.37	0.52	0.11	0.28	0.58	0.29	0.79	0.43
Control Delay	7.0	9.8	6.6	9.3	82.0	26.9	96.0	18.3
Queue Delay	0.0	0.0	0.0	0.0	0.0	0.0	0.0	0.0
Total Delay	7.0	9.8	6.6	9.3	82.0	26.9	96.0	18.3
Queue Length 50th (ft)	34	309	3	125	72	24	141	20
Queue Length 95th (ft)	67	424	12	187	123	73	210	82
Internal Link Dist (ft)		2560		1156		610		2153
Turn Bay Length (ft)	200		200		190		190	
Base Capacity (vph)	526	3815	313	3548	247	471	343	503
Starvation Cap Reductn	0	0	0	0	0	0	0	0
Spillback Cap Reductn	0	0	0	0	0	0	0	0
Storage Cap Reductn	0	0	0	0	0	0	0	0
Reduced v/c Ratio	0.31	0.52	0.06	0.28	0.29	0.16	0.40	0.27

Intersection Summary

HCM 6th Signalized Intersection Summary

111: NW 66 Avenue & Atlantic Boulevard



Movement	EBL	EBT	EBR	WBL	WBT	WBR	NBL	NBT	NBR	SBL	SBT	SBR
Lane Configurations	↖	↑↑↑		↖	↑↑↑		↖	↑		↖	↑	
Traffic Volume (veh/h)	148	1789	31	17	831	81	66	24	45	126	19	104
Future Volume (veh/h)	148	1789	31	17	831	81	66	24	45	126	19	104
Initial Q (Qb), veh	0	0	0	0	0	0	0	0	0	0	0	0
Ped-Bike Adj(A_pbT)	1.00		1.00	1.00		0.98	0.99		0.99	0.99		0.99
Parking Bus, Adj	1.00	1.00	1.00	1.00	1.00	1.00	1.00	1.00	1.00	1.00	1.00	1.00
Work Zone On Approach		No			No			No			No	
Adj Sat Flow, veh/h/ln	1870	1870	1870	1870	1870	1870	1870	1870	1870	1870	1870	1870
Adj Flow Rate, veh/h	161	1945	34	18	903	88	72	26	49	137	21	113
Peak Hour Factor	0.92	0.92	0.92	0.92	0.92	0.92	0.92	0.92	0.92	0.92	0.92	0.92
Percent Heavy Veh, %	2	2	2	2	2	2	2	2	2	2	2	2
Cap, veh/h	461	3658	64	186	3215	312	161	96	180	214	42	225
Arrive On Green	0.04	0.71	0.71	0.01	0.68	0.68	0.22	0.22	0.22	0.22	0.22	0.22
Sat Flow, veh/h	1781	5168	90	1781	4722	458	1247	576	1085	1313	252	1357
Grp Volume(v), veh/h	161	1281	698	18	650	341	72	0	75	137	0	134
Grp Sat Flow(s),veh/h/ln	1781	1702	1854	1781	1702	1776	1247	0	1661	1313	0	1609
Q Serve(g_s), s	4.4	28.2	28.2	0.5	12.0	12.1	8.8	0.0	6.0	16.1	0.0	11.7
Cycle Q Clear(g_c), s	4.4	28.2	28.2	0.5	12.0	12.1	20.5	0.0	6.0	22.1	0.0	11.7
Prop In Lane	1.00		0.05	1.00		0.26	1.00		0.65	1.00		0.84
Lane Grp Cap(c), veh/h	461	2409	1312	186	2318	1209	161	0	276	214	0	267
V/C Ratio(X)	0.35	0.53	0.53	0.10	0.28	0.28	0.45	0.00	0.27	0.64	0.00	0.50
Avail Cap(c_a), veh/h	600	2409	1312	373	2318	1209	281	0	436	341	0	422
HCM Platoon Ratio	1.00	1.00	1.00	1.00	1.00	1.00	1.33	1.33	1.33	1.33	1.33	1.33
Upstream Filter(I)	1.00	1.00	1.00	1.00	1.00	1.00	1.00	0.00	1.00	1.00	0.00	1.00
Uniform Delay (d), s/veh	7.4	11.0	11.0	9.5	10.1	10.1	65.5	0.0	54.3	63.5	0.0	56.5
Incr Delay (d2), s/veh	0.2	0.8	1.5	0.1	0.3	0.6	0.7	0.0	0.2	1.2	0.0	0.5
Initial Q Delay(d3),s/veh	0.0	0.0	0.0	0.0	0.0	0.0	0.0	0.0	0.0	0.0	0.0	0.0
%ile BackOfQ(50%),veh/ln	1.7	10.7	11.9	0.2	4.6	5.0	2.8	0.0	2.5	5.3	0.0	4.7
Unsig. Movement Delay, s/veh												
LnGrp Delay(d),s/veh	7.6	11.8	12.5	9.6	10.4	10.7	66.2	0.0	54.5	64.7	0.0	57.1
LnGrp LOS	A	B	B	A	B	B	E	A	D	E	A	E
Approach Vol, veh/h		2140			1009			147				271
Approach Delay, s/veh		11.7			10.5			60.3				60.9
Approach LOS		B			B			E				E
Timer - Assigned Phs	1	2		4	5	6		8				
Phs Duration (G+Y+Rc), s	12.5	115.0		32.6	8.2	119.2		32.6				
Change Period (Y+Rc), s	6.0	6.0		6.0	6.0	6.0		6.0				
Max Green Setting (Gmax), s	19.0	81.0		42.0	19.0	81.0		42.0				
Max Q Clear Time (g_c+I1), s	6.4	14.1		22.5	2.5	30.2		24.1				
Green Ext Time (p_c), s	0.1	8.6		0.3	0.0	25.1		0.7				

Intersection Summary

HCM 6th Ctrl Delay	17.1
HCM 6th LOS	B

Notes

User approved pedestrian interval to be less than phase max green.

HCM 6th AWSC
 112: NW 66 Avenue & Margate Boulevard

Intersection	
Intersection Delay, s/veh	16.1
Intersection LOS	C

Movement	EBL	EBT	EBR	WBL	WBT	WBR	NBL	NBT	NBR	SBL	SBT	SBR
Lane Configurations												
Traffic Vol, veh/h	93	493	60	24	133	18	37	56	64	44	73	64
Future Vol, veh/h	93	493	60	24	133	18	37	56	64	44	73	64
Peak Hour Factor	0.87	0.87	0.87	0.87	0.87	0.87	0.87	0.87	0.87	0.87	0.87	0.87
Heavy Vehicles, %	2	2	2	2	2	2	2	2	2	2	2	2
Mvmt Flow	107	567	69	28	153	21	43	64	74	51	84	74
Number of Lanes	1	2	0	0	2	0	0	1	0	0	1	0

Approach	EB	WB	NB	SB
Opposing Approach	WB	EB	SB	NB
Opposing Lanes	2	3	1	1
Conflicting Approach Left	SB	NB	EB	WB
Conflicting Lanes Left	1	1	3	2
Conflicting Approach Right	NB	SB	WB	EB
Conflicting Lanes Right	1	1	2	3
HCM Control Delay	17.6	12.9	14.4	15.4
HCM LOS	C	B	B	C

Lane	NBLn1	EBLn1	EBLn2	EBLn3	WBLn1	WBLn2	SBLn1
Vol Left, %	24%	100%	0%	0%	27%	0%	24%
Vol Thru, %	36%	0%	100%	73%	73%	79%	40%
Vol Right, %	41%	0%	0%	27%	0%	21%	35%
Sign Control	Stop	Stop	Stop	Stop	Stop	Stop	Stop
Traffic Vol by Lane	157	93	329	224	91	85	181
LT Vol	37	93	0	0	24	0	44
Through Vol	56	0	329	164	67	67	73
RT Vol	64	0	0	60	0	18	64
Lane Flow Rate	180	107	378	258	104	97	208
Geometry Grp	7	7	7	7	8	8	7
Degree of Util (X)	0.369	0.207	0.679	0.45	0.232	0.209	0.423
Departure Headway (Hd)	7.356	6.984	6.474	6.283	8.036	7.746	7.323
Convergence, Y/N	Yes	Yes	Yes	Yes	Yes	Yes	Yes
Cap	489	517	563	578	446	463	491
Service Time	5.1	4.684	4.174	3.983	5.789	5.499	5.066
HCM Lane V/C Ratio	0.368	0.207	0.671	0.446	0.233	0.21	0.424
HCM Control Delay	14.4	11.5	21.8	14	13.2	12.5	15.4
HCM Lane LOS	B	B	C	B	B	B	C
HCM 95th-tile Q	1.7	0.8	5.2	2.3	0.9	0.8	2.1

Timings

101: Rock Island Road & Royal Palm Boulevard

Lane Group	EBL	EBT	WBL	WBT	NBL	NBT	NBR	SBL	SBT	SBR
Lane Configurations										
Traffic Volume (vph)	159	971	169	808	393	628	245	237	709	177
Future Volume (vph)	159	971	169	808	393	628	245	237	709	177
Turn Type	Prot	NA	Prot	NA	pm+pt	NA	Perm	pm+pt	NA	Perm
Protected Phases	1	6	5	2	7	4		3	8	
Permitted Phases					4		4	8		8
Detector Phase	1	6	5	2	7	4	4	3	8	8
Switch Phase										
Minimum Initial (s)	5.0	10.0	5.0	10.0	4.0	6.0	6.0	4.0	6.0	6.0
Minimum Split (s)	11.5	43.5	11.5	43.5	10.5	43.5	43.5	10.5	42.0	42.0
Total Split (s)	26.0	60.0	26.0	60.0	32.0	46.0	46.0	28.0	42.0	42.0
Total Split (%)	16.3%	37.5%	16.3%	37.5%	20.0%	28.8%	28.8%	17.5%	26.3%	26.3%
Yellow Time (s)	4.5	4.5	4.5	4.5	4.5	4.5	4.5	4.5	4.5	4.5
All-Red Time (s)	2.0	2.0	2.0	2.0	2.0	2.0	2.0	2.0	2.0	2.0
Lost Time Adjust (s)	0.0	0.0	0.0	0.0	0.0	0.0	0.0	0.0	0.0	0.0
Total Lost Time (s)	6.5	6.5	6.5	6.5	6.5	6.5	6.5	6.5	6.5	6.5
Lead/Lag	Lead	Lag	Lead	Lag	Lead	Lag	Lag	Lead	Lag	Lag
Lead-Lag Optimize?	Yes	Yes	Yes	Yes	Yes	Yes	Yes	Yes	Yes	Yes
Recall Mode	None	C-Max	None	C-Max	None	None	None	None	None	None
Act Effct Green (s)	17.8	54.6	18.4	55.2	66.0	41.6	41.6	54.9	35.5	35.5
Actuated g/C Ratio	0.11	0.34	0.12	0.34	0.41	0.26	0.26	0.34	0.22	0.22
v/c Ratio	0.88	1.25	0.91	0.92	1.31	0.74	0.50	0.87	0.98	0.44
Control Delay	108.2	162.9	111.2	61.8	199.9	81.0	42.3	61.2	89.2	25.5
Queue Delay	0.0	0.0	0.0	0.0	0.0	0.0	0.0	0.0	0.0	0.0
Total Delay	108.2	162.9	111.2	61.8	199.9	81.0	42.3	61.2	89.2	25.5
LOS	F	F	F	E	F	F	D	E	F	C
Approach Delay		157.1		68.9		110.4			73.3	
Approach LOS		F		E		F			E	

Intersection Summary

Cycle Length: 160

Actuated Cycle Length: 160

Offset: 49 (31%), Referenced to phase 2:WBT and 6:EBT, Start of Yellow

Natural Cycle: 150

Control Type: Actuated-Coordinated

Maximum v/c Ratio: 1.31

Intersection Signal Delay: 106.6

Intersection LOS: F

Intersection Capacity Utilization 112.1%

ICU Level of Service H

Analysis Period (min) 15

Splits and Phases: 101: Rock Island Road & Royal Palm Boulevard

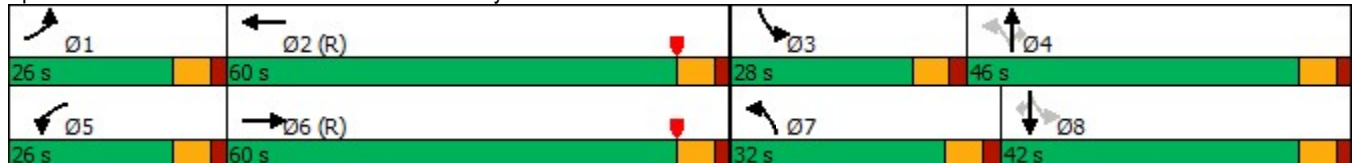

Queues

101: Rock Island Road & Royal Palm Boulevard



Lane Group	EBL	EBT	WBL	WBT	NBL	NBT	NBR	SBL	SBT	SBR
Lane Group Flow (vph)	173	1480	184	1093	427	683	266	258	771	192
v/c Ratio	0.88	1.25	0.91	0.92	1.31	0.74	0.50	0.87	0.98	0.44
Control Delay	108.2	162.9	111.2	61.8	199.9	81.0	42.3	61.2	89.2	25.5
Queue Delay	0.0	0.0	0.0	0.0	0.0	0.0	0.0	0.0	0.0	0.0
Total Delay	108.2	162.9	111.2	61.8	199.9	81.0	42.3	61.2	89.2	25.5
Queue Length 50th (ft)	179	~1015	192	578	~535	379	142	181	426	70
Queue Length 95th (ft)	#304	#1156	#332	#719	#729	457	241	#303	#566	152
Internal Link Dist (ft)		625		856		3088			735	
Turn Bay Length (ft)	300		200		200		160	140		170
Base Capacity (vph)	215	1181	215	1194	327	920	527	322	785	432
Starvation Cap Reductn	0	0	0	0	0	0	0	0	0	0
Spillback Cap Reductn	0	0	0	0	0	0	0	0	0	0
Storage Cap Reductn	0	0	0	0	0	0	0	0	0	0
Reduced v/c Ratio	0.80	1.25	0.86	0.92	1.31	0.74	0.50	0.80	0.98	0.44

Intersection Summary

~ Volume exceeds capacity, queue is theoretically infinite.

Queue shown is maximum after two cycles.

95th percentile volume exceeds capacity, queue may be longer.

Queue shown is maximum after two cycles.

HCM 6th Signalized Intersection Summary

101: Rock Island Road & Royal Palm Boulevard

Movement	EBL	EBT	EBR	WBL	WBT	WBR	NBL	NBT	NBR	SBL	SBT	SBR
Lane Configurations												
Traffic Volume (veh/h)	159	971	391	169	808	198	393	628	245	237	709	177
Future Volume (veh/h)	159	971	391	169	808	198	393	628	245	237	709	177
Initial Q (Qb), veh	0	0	0	0	0	0	0	0	0	0	0	0
Ped-Bike Adj(A_pbT)	1.00		1.00	1.00		0.99	1.00		0.99	1.00		0.98
Parking Bus, Adj	1.00	1.00	1.00	1.00	1.00	1.00	1.00	1.00	1.00	1.00	1.00	1.00
Work Zone On Approach		No			No			No			No	
Adj Sat Flow, veh/h/ln	1870	1870	1870	1870	1870	1870	1870	1870	1870	1870	1870	1870
Adj Flow Rate, veh/h	173	1055	425	184	878	215	427	683	266	258	771	192
Peak Hour Factor	0.92	0.92	0.92	0.92	0.92	0.92	0.92	0.92	0.92	0.92	0.92	0.92
Percent Heavy Veh, %	2	2	2	2	2	2	2	2	2	2	2	2
Cap, veh/h	193	851	336	203	982	240	333	915	402	322	788	346
Arrive On Green	0.14	0.45	0.45	0.15	0.46	0.46	0.27	0.43	0.43	0.12	0.22	0.22
Sat Flow, veh/h	1781	2487	983	1781	2822	691	1781	3554	1561	1781	3554	1559
Grp Volume(v), veh/h	173	748	732	184	553	540	427	683	266	258	771	192
Grp Sat Flow(s),veh/h/ln	1781	1777	1693	1781	1777	1736	1781	1777	1561	1781	1777	1559
Q Serve(g_s), s	15.3	54.7	54.7	16.3	45.6	45.7	25.5	25.8	21.7	17.7	34.5	17.5
Cycle Q Clear(g_c), s	15.3	54.7	54.7	16.3	45.6	45.7	25.5	25.8	21.7	17.7	34.5	17.5
Prop In Lane	1.00		0.58	1.00		0.40	1.00		1.00	1.00		1.00
Lane Grp Cap(c), veh/h	193	608	579	203	619	604	333	915	402	322	788	346
V/C Ratio(X)	0.90	1.23	1.26	0.90	0.89	0.89	1.28	0.75	0.66	0.80	0.98	0.56
Avail Cap(c_a), veh/h	217	608	579	217	619	604	333	915	402	341	788	346
HCM Platoon Ratio	1.33	1.33	1.33	1.33	1.33	1.33	1.67	1.67	1.67	1.00	1.00	1.00
Upstream Filter(l)	1.00	1.00	1.00	1.00	1.00	1.00	0.92	0.92	0.92	1.00	1.00	1.00
Uniform Delay (d), s/veh	67.6	43.6	43.6	67.0	40.2	40.3	42.5	41.2	40.0	42.3	61.9	55.2
Incr Delay (d2), s/veh	30.8	117.8	131.9	33.8	17.8	18.2	147.3	2.8	3.0	11.0	26.5	1.2
Initial Q Delay(d3),s/veh	0.0	0.0	0.0	0.0	0.0	0.0	0.0	0.0	0.0	0.0	0.0	0.0
%ile BackOfQ(50%),veh/ln	8.4	42.6	42.9	9.1	21.9	21.5	23.9	10.6	7.9	8.9	18.5	7.1
Unsig. Movement Delay, s/veh												
LnGrp Delay(d),s/veh	98.5	161.4	175.5	100.8	58.0	58.5	189.9	44.0	43.0	53.3	88.3	56.4
LnGrp LOS	F	F	F	F	E	E	F	D	D	D	F	E
Approach Vol, veh/h		1653			1277			1376			1221	
Approach Delay, s/veh		161.1			64.4			89.1			75.9	
Approach LOS		F			E			F			E	
Timer - Assigned Phs	1	2	3	4	5	6	7	8				
Phs Duration (G+Y+Rc), s	23.8	62.2	26.3	47.7	24.8	61.2	32.0	42.0				
Change Period (Y+Rc), s	6.5	6.5	6.5	6.5	6.5	6.5	6.5	6.5				
Max Green Setting (Gmax), s	19.5	53.5	21.5	39.5	19.5	53.5	25.5	35.5				
Max Q Clear Time (g_c+l1), s	17.3	47.7	19.7	27.8	18.3	56.7	27.5	36.5				
Green Ext Time (p_c), s	0.0	3.4	0.1	3.0	0.0	0.0	0.0	0.0				
Intersection Summary												
HCM 6th Ctrl Delay			102.0									
HCM 6th LOS			F									
Notes												
User approved pedestrian interval to be less than phase max green.												

HCM 6th TWSC
 102: NW 76 Avenue & Margate Boulevard

Intersection						
Int Delay, s/veh	3.5					
Movement	EBT	EBR	WBL	WBT	NBL	NBR
Lane Configurations	↑↑		↖	↑↑	↗	
Traffic Vol, veh/h	113	186	68	62	81	58
Future Vol, veh/h	113	186	68	62	81	58
Conflicting Peds, #/hr	0	2	2	0	3	2
Sign Control	Free	Free	Free	Free	Stop	Stop
RT Channelized	-	None	-	None	-	None
Storage Length	-	-	100	-	0	-
Veh in Median Storage, #	0	-	-	0	1	-
Grade, %	0	-	-	0	0	-
Peak Hour Factor	85	85	85	85	85	85
Heavy Vehicles, %	2	2	2	2	2	2
Mvmt Flow	133	219	80	73	95	68

Major/Minor	Major1	Major2	Minor1	Minor2	Minor3
Conflicting Flow All	0	0	354	0	445
Stage 1	-	-	-	-	245
Stage 2	-	-	-	-	200
Critical Hdwy	-	-	4.14	-	5
Critical Hdwy Stg 1	-	-	-	-	5
Critical Hdwy Stg 2	-	-	-	-	5
Follow-up Hdwy	-	-	2.22	-	3
Pot Cap-1 Maneuver	-	-	1201	-	774
Stage 1	-	-	-	-	944
Stage 2	-	-	-	-	987
Platoon blocked, %	-	-	-	-	-
Mov Cap-1 Maneuver	-	-	1199	-	718
Mov Cap-2 Maneuver	-	-	-	-	752
Stage 1	-	-	-	-	942
Stage 2	-	-	-	-	918

Approach	EB	WB	NB
HCM Control Delay, s	0	4.3	10.3
HCM LOS			B

Minor Lane/Major Mvmt	NBLn1	EBT	EBR	WBL	WBT
Capacity (veh/h)	847	-	-	1199	-
HCM Lane V/C Ratio	0.193	-	-	0.067	-
HCM Control Delay (s)	10.3	-	-	8.2	-
HCM Lane LOS	B	-	-	A	-
HCM 95th %tile Q(veh)	0.7	-	-	0.2	-

Timings

103: Rock Island Road & Margate Boulevard



Lane Group	EBL	EBT	WBL	WBT	NBL	NBT	NBR	SBL	SBT	SBR
Lane Configurations										
Traffic Volume (vph)	71	106	151	66	13	855	341	180	960	56
Future Volume (vph)	71	106	151	66	13	855	341	180	960	56
Turn Type	pm+pt	NA	pm+pt	NA	pm+pt	NA	Perm	pm+pt	NA	Perm
Protected Phases	7	4	3	8	5	2		1	6	
Permitted Phases	4		8		2		2	6		6
Detector Phase	7	4	3	8	5	2	2	1	6	6
Switch Phase										
Minimum Initial (s)	4.0	6.0	4.0	6.0	4.0	12.0	12.0	4.0	12.0	12.0
Minimum Split (s)	10.0	37.0	10.0	37.0	10.5	37.5	37.5	10.5	37.5	37.5
Total Split (s)	19.0	40.0	19.0	40.0	23.0	78.0	78.0	23.0	78.0	78.0
Total Split (%)	11.9%	25.0%	11.9%	25.0%	14.4%	48.8%	48.8%	14.4%	48.8%	48.8%
Yellow Time (s)	4.0	4.0	4.0	4.0	4.5	4.5	4.5	4.5	4.5	4.5
All-Red Time (s)	2.0	2.0	2.0	2.0	2.0	2.0	2.0	2.0	2.0	2.0
Lost Time Adjust (s)	0.0	0.0	0.0	0.0	0.0	0.0	0.0	0.0	0.0	0.0
Total Lost Time (s)	6.0	6.0	6.0	6.0	6.5	6.5	6.5	6.5	6.5	6.5
Lead/Lag	Lead	Lag	Lead	Lag	Lead	Lag	Lag	Lead	Lag	Lag
Lead-Lag Optimize?	Yes	Yes	Yes	Yes	Yes	Yes	Yes	Yes	Yes	Yes
Recall Mode	None	None	None	None	None	C-Max	C-Max	None	C-Max	C-Max
Act Effct Green (s)	19.7	10.1	25.6	13.1	107.5	103.1	103.1	118.6	114.3	114.3
Actuated g/C Ratio	0.12	0.06	0.16	0.08	0.67	0.64	0.64	0.74	0.71	0.71
v/c Ratio	0.41	0.60	0.74	0.44	0.04	0.39	0.33	0.44	0.40	0.05
Control Delay	62.5	74.3	80.4	36.2	8.5	12.9	5.2	8.3	4.9	0.0
Queue Delay	0.0	0.0	0.0	0.0	0.0	0.0	0.0	0.0	0.0	0.0
Total Delay	62.5	74.3	80.4	36.2	8.5	12.9	5.2	8.3	4.9	0.0
LOS	E	E	F	D	A	B	A	A	A	A
Approach Delay		70.2		58.8		10.7			5.2	
Approach LOS		E		E		B			A	

Intersection Summary

Cycle Length: 160

Actuated Cycle Length: 160

Offset: 90 (56%), Referenced to phase 2:NBTL and 6:SBTL, Start of Yellow

Natural Cycle: 95

Control Type: Actuated-Coordinated

Maximum v/c Ratio: 0.74

Intersection Signal Delay: 17.5

Intersection LOS: B

Intersection Capacity Utilization 71.3%

ICU Level of Service C

Analysis Period (min) 15

Splits and Phases: 103: Rock Island Road & Margate Boulevard

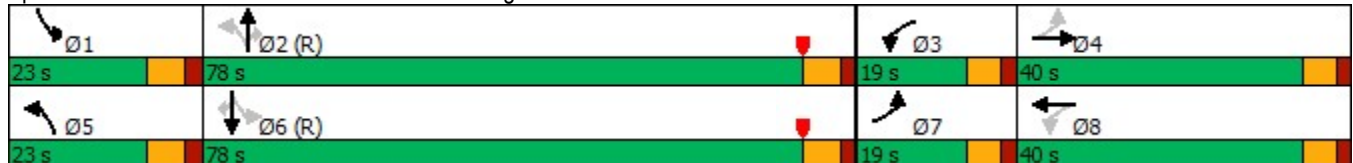

Queues

103: Rock Island Road & Margate Boulevard



Lane Group	EBL	EBT	WBL	WBT	NBL	NBT	NBR	SBL	SBT	SBR
Lane Group Flow (vph)	75	139	159	152	14	900	359	189	1011	56
v/c Ratio	0.41	0.60	0.74	0.44	0.04	0.39	0.33	0.44	0.40	0.05
Control Delay	62.5	74.3	80.4	36.2	8.5	12.9	5.2	8.3	4.9	0.0
Queue Delay	0.0	0.0	0.0	0.0	0.0	0.0	0.0	0.0	0.0	0.0
Total Delay	62.5	74.3	80.4	36.2	8.5	12.9	5.2	8.3	4.9	0.0
Queue Length 50th (ft)	68	66	152	36	3	132	10	31	87	0
Queue Length 95th (ft)	117	104	#235	75	m7	221	m88	m36	m103	m0
Internal Link Dist (ft)		2155		508		3616			3088	
Turn Bay Length (ft)	320		110		180		180	190		160
Base Capacity (vph)	221	741	218	755	495	2280	1093	489	2528	1161
Starvation Cap Reductn	0	0	0	0	0	0	0	0	0	0
Spillback Cap Reductn	0	0	0	0	0	0	0	0	0	0
Storage Cap Reductn	0	0	0	0	0	0	0	0	0	0
Reduced v/c Ratio	0.34	0.19	0.73	0.20	0.03	0.39	0.33	0.39	0.40	0.05

Intersection Summary

95th percentile volume exceeds capacity, queue may be longer.

Queue shown is maximum after two cycles.

m Volume for 95th percentile queue is metered by upstream signal.

HCM 6th Signalized Intersection Summary
 103: Rock Island Road & Margate Boulevard

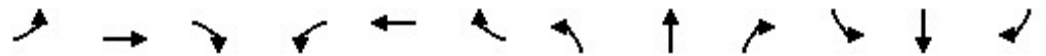

Movement	EBL	EBT	EBR	WBL	WBT	WBR	NBL	NBT	NBR	SBL	SBT	SBR
Lane Configurations												
Traffic Volume (veh/h)	71	106	26	151	66	79	13	855	341	180	960	56
Future Volume (veh/h)	71	106	26	151	66	79	13	855	341	180	960	56
Initial Q (Qb), veh	0	0	0	0	0	0	0	0	0	0	0	0
Ped-Bike Adj(A_pbT)	0.99		0.99	1.00		0.99	1.00		1.00	1.00		1.00
Parking Bus, Adj	1.00	1.00	1.00	1.00	1.00	1.00	1.00	1.00	1.00	1.00	1.00	1.00
Work Zone On Approach		No			No			No			No	
Adj Sat Flow, veh/h/ln	1870	1870	1870	1870	1870	1870	1870	1870	1870	1870	1870	1870
Adj Flow Rate, veh/h	75	112	27	159	69	83	14	900	359	189	1011	56
Peak Hour Factor	0.95	0.95	0.95	0.95	0.95	0.95	0.95	0.95	0.95	0.95	0.95	1.00
Percent Heavy Veh, %	2	2	2	2	2	2	2	2	2	2	2	2
Cap, veh/h	193	191	45	224	175	155	405	2298	1024	394	2431	1083
Arrive On Green	0.05	0.07	0.07	0.08	0.10	0.10	0.02	0.86	0.84	0.07	0.91	0.91
Sat Flow, veh/h	1781	2854	667	1781	1777	1575	1781	3554	1583	1781	3554	1583
Grp Volume(v), veh/h	75	68	71	159	69	83	14	900	359	189	1011	56
Grp Sat Flow(s),veh/h/ln	1781	1777	1743	1781	1777	1575	1781	1777	1583	1781	1777	1583
Q Serve(g_s), s	6.2	6.0	6.3	13.0	5.8	8.0	0.4	8.6	8.2	5.7	6.6	0.5
Cycle Q Clear(g_c), s	6.2	6.0	6.3	13.0	5.8	8.0	0.4	8.6	8.2	5.7	6.6	0.5
Prop In Lane	1.00		0.38	1.00		1.00	1.00		1.00	1.00		1.00
Lane Grp Cap(c), veh/h	193	119	117	224	175	155	405	2298	1024	394	2431	1083
V/C Ratio(X)	0.39	0.58	0.61	0.71	0.39	0.53	0.03	0.39	0.35	0.48	0.42	0.05
Avail Cap(c_a), veh/h	249	378	370	224	378	335	568	2298	1024	490	2431	1083
HCM Platoon Ratio	1.00	1.00	1.00	1.00	1.00	1.00	1.33	1.33	1.30	1.33	1.33	1.33
Upstream Filter(l)	1.00	1.00	1.00	1.00	1.00	1.00	0.45	0.45	0.45	0.30	0.30	0.30
Uniform Delay (d), s/veh	65.2	72.4	72.6	63.1	67.6	68.6	9.4	4.6	5.2	8.2	2.6	2.3
Incr Delay (d2), s/veh	0.5	1.6	1.9	8.6	0.5	1.1	0.0	0.2	0.4	0.1	0.2	0.0
Initial Q Delay(d3),s/veh	0.0	0.0	0.0	0.0	0.0	0.0	0.0	0.0	0.0	0.0	0.0	0.0
%ile BackOfQ(50%),veh/ln	2.9	2.8	2.9	6.6	2.7	3.3	0.2	2.6	0.1	2.1	1.8	0.2
Unsig. Movement Delay, s/veh												
LnGrp Delay(d),s/veh	65.7	74.1	74.5	71.7	68.2	69.7	9.4	4.8	5.6	8.3	2.7	2.3
LnGrp LOS	E	E	E	E	E	E	A	A	A	A	A	A
Approach Vol, veh/h		214			311			1273			1256	
Approach Delay, s/veh		71.3			70.4			5.1			3.6	
Approach LOS		E			E			A			A	
Timer - Assigned Phs	1	2	3	4	5	6	7	8				
Phs Duration (G+Y+Rc), s	14.3	110.0	19.0	16.7	8.4	115.9	13.9	21.8				
Change Period (Y+Rc), s	6.5	6.5	6.0	6.0	6.5	6.5	6.0	6.0				
Max Green Setting (Gmax), s	16.5	71.5	13.0	34.0	16.5	71.5	13.0	34.0				
Max Q Clear Time (g_c+I1), s	7.7	10.6	15.0	8.3	2.4	8.6	8.2	10.0				
Green Ext Time (p_c), s	0.1	10.3	0.0	0.5	0.0	10.0	0.0	0.5				
Intersection Summary												
HCM 6th Ctrl Delay				15.7								
HCM 6th LOS				B								

Timings

104: SR 7 & Margate Boulevard



Lane Group	EBL	EBR	NBL	NBT	SBL	SBT	Ø3
Lane Configurations	↖↗	↖	↖	↑↑↑	↖	↑↑↑	
Traffic Volume (vph)	533	182	38	2188	6	1760	
Future Volume (vph)	533	182	38	2188	6	1760	
Turn Type	Prot	Perm	Prot	NA	Prot	NA	
Protected Phases	4		5	2	1	6	3
Permitted Phases		4					
Detector Phase	4	4	5	2	1	6	
Switch Phase							
Minimum Initial (s)	7.0	7.0	4.0	12.0	4.0	12.0	5.0
Minimum Split (s)	44.5	44.5	11.5	43.0	10.0	44.5	19.0
Total Split (s)	45.0	45.0	15.0	81.0	15.0	81.0	19.0
Total Split (%)	28.1%	28.1%	9.4%	50.6%	9.4%	50.6%	12%
Yellow Time (s)	4.0	4.0	4.0	4.0	4.0	4.0	4.0
All-Red Time (s)	2.5	2.5	2.0	2.0	2.0	2.0	2.5
Lost Time Adjust (s)	0.0	0.0	0.0	0.0	0.0	0.0	
Total Lost Time (s)	6.5	6.5	6.0	6.0	6.0	6.0	
Lead/Lag	Lag	Lag	Lead	Lag	Lead	Lag	Lead
Lead-Lag Optimize?	Yes	Yes	Yes	Yes	Yes	Yes	Yes
Recall Mode	None	None	None	C-Max	None	C-Max	None
Act Effct Green (s)	29.8	29.8	7.4	115.4	4.7	106.3	
Actuated g/C Ratio	0.19	0.19	0.05	0.72	0.03	0.66	
v/c Ratio	0.85	0.42	0.48	0.61	0.12	0.57	
Control Delay	76.1	9.4	50.6	27.7	80.0	16.5	
Queue Delay	0.0	0.0	0.0	0.0	0.0	0.0	
Total Delay	76.1	9.4	50.6	27.7	80.0	16.5	
LOS	E	A	D	C	E	B	
Approach Delay				28.1		16.7	
Approach LOS				C		B	

Intersection Summary

Cycle Length: 160	
Actuated Cycle Length: 160	
Offset: 138 (86%), Referenced to phase 2:NBT and 6:SBT, Start of Yellow	
Natural Cycle: 140	
Control Type: Actuated-Coordinated	
Maximum v/c Ratio: 0.85	
Intersection Signal Delay: 28.3	Intersection LOS: C
Intersection Capacity Utilization 65.8%	ICU Level of Service C
Analysis Period (min) 15	

Splits and Phases: 104: SR 7 & Margate Boulevard

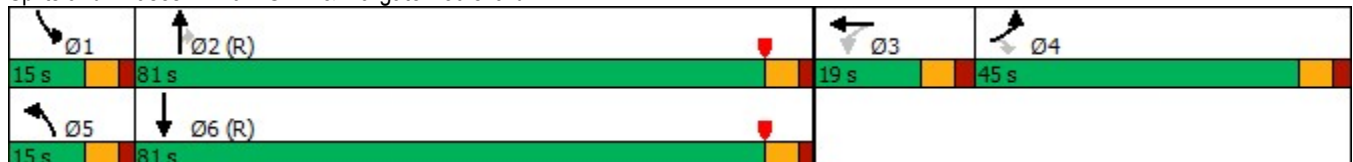

Queues

104: SR 7 & Margate Boulevard





























Lane Group	EBL	EBR	NBL	NBT	SBL	SBT
Lane Group Flow (vph)	544	186	39	2233	6	1902
v/c Ratio	0.85	0.42	0.48	0.61	0.12	0.57
Control Delay	76.1	9.4	50.6	27.7	80.0	16.5
Queue Delay	0.0	0.0	0.0	0.0	0.0	0.0
Total Delay	76.1	9.4	50.6	27.7	80.0	16.5
Queue Length 50th (ft)	287	0	39	589	6	384
Queue Length 95th (ft)	340	67	m37	m603	24	506
Internal Link Dist (ft)				2153		276
Turn Bay Length (ft)	120	120	250		200	
Base Capacity (vph)	826	517	103	3666	99	3350
Starvation Cap Reductn	0	0	0	0	0	0
Spillback Cap Reductn	0	0	0	0	0	0
Storage Cap Reductn	0	0	0	0	0	0
Reduced v/c Ratio	0.66	0.36	0.38	0.61	0.06	0.57

Intersection Summary

m Volume for 95th percentile queue is metered by upstream signal.

HCM Signalized Intersection Capacity Analysis

104: SR 7 & Margate Boulevard

												
Movement	EBL	EBT	EBR	WBL	WBT	WBR	NBL	NBT	NBR	SBL	SBT	SBR
Lane Configurations	 				 			  			  	
Traffic Volume (vph)	533	0	182	0	0	0	38	2188	0	6	1760	104
Future Volume (vph)	533	0	182	0	0	0	38	2188	0	6	1760	104
Ideal Flow (vphpl)	1900	1900	1900	1900	1900	1900	1900	1900	1900	1900	1900	1900
Total Lost time (s)	6.5		6.5				6.0	6.0		6.0	6.0	
Lane Util. Factor	0.97		1.00				1.00	0.91		1.00	0.91	
Frbp, ped/bikes	1.00		0.99				1.00	1.00		1.00	1.00	
Flpb, ped/bikes	1.00		1.00				1.00	1.00		1.00	1.00	
Frt	1.00		0.85				1.00	1.00		1.00	0.99	
Flt Protected	0.95		1.00				0.95	1.00		0.95	1.00	
Satd. Flow (prot)	3433		1562				1770	5085		1770	5036	
Flt Permitted	0.95		1.00				0.95	1.00		0.95	1.00	
Satd. Flow (perm)	3433		1562				1770	5085		1770	5036	
Peak-hour factor, PHF	0.98	0.98	0.98	0.98	0.98	0.98	0.98	0.98	0.98	0.98	0.98	0.98
Adj. Flow (vph)	544	0	186	0	0	0	39	2233	0	6	1796	106
RTOR Reduction (vph)	0	0	151	0	0	0	0	0	0	0	3	0
Lane Group Flow (vph)	544	0	35	0	0	0	39	2233	0	6	1899	0
Confl. Peds. (#/hr)			1	1			1					1
Turn Type	Prot		Perm				Prot	NA	Perm	Prot	NA	
Protected Phases	4				3		5	2		1	6	
Permitted Phases			4	3					2			
Actuated Green, G (s)	29.8		29.8				6.6	110.5		1.2	105.1	
Effective Green, g (s)	29.8		29.8				6.6	110.5		1.2	105.1	
Actuated g/C Ratio	0.19		0.19				0.04	0.69		0.01	0.66	
Clearance Time (s)	6.5		6.5				6.0	6.0		6.0	6.0	
Vehicle Extension (s)	2.0		2.0				1.5	3.0		1.5	3.0	
Lane Grp Cap (vph)	639		290				73	3511		13	3308	
v/s Ratio Prot	c0.16						c0.02	c0.44		0.00	0.38	
v/s Ratio Perm			0.02									
v/c Ratio	0.85		0.12				0.53	0.64		0.46	0.57	
Uniform Delay, d1	63.0		54.2				75.2	13.7		79.1	15.1	
Progression Factor	1.00		1.00				0.66	2.25		1.00	1.00	
Incremental Delay, d2	10.2		0.1				0.3	0.1		9.1	0.7	
Delay (s)	73.2		54.2				50.2	30.8		88.2	15.9	
Level of Service	E		D				D	C		F	B	
Approach Delay (s)		68.4			0.0			31.1			16.1	
Approach LOS		E			A			C			B	
Intersection Summary												
HCM 2000 Control Delay			30.8				HCM 2000 Level of Service			C		
HCM 2000 Volume to Capacity ratio			0.73									
Actuated Cycle Length (s)			160.0				Sum of lost time (s)			25.0		
Intersection Capacity Utilization			65.8%				ICU Level of Service			C		
Analysis Period (min)			15									
c Critical Lane Group												

HCM 6th Signalized Intersection Summary
104: SR 7 & Margate Boulevard

HCM 6th Edition methodology expects strict NEMA phasing.

Timings

105: Riverside Drive & Atlantic Boulevard /Atlantic Boulevard

Lane Group	EBL	EBT	EBR	WBL	WBT	WBR	NBL	NBT	NBR	SBL	SBT	SBR
Lane Configurations												
Traffic Volume (vph)	101	967	72	204	736	251	22	617	363	346	431	180
Future Volume (vph)	101	967	72	204	736	251	22	617	363	346	431	180
Turn Type	Prot	NA	Perm	Prot	NA	Perm	Prot	NA	Perm	Prot	NA	Perm
Protected Phases	1	6		5	2		7	4		3	8	
Permitted Phases			6			2			4			8
Detector Phase	1	6	6	5	2	2	7	4	4	3	8	8
Switch Phase												
Minimum Initial (s)	5.0	12.0	12.0	5.0	12.0	12.0	4.0	6.0	6.0	5.0	6.0	6.0
Minimum Split (s)	11.0	36.0	36.0	24.0	36.0	36.0	10.0	32.0	32.0	11.0	20.0	20.0
Total Split (s)	60.0	50.0	50.0	60.0	50.0	50.0	30.0	32.0	32.0	18.0	20.0	20.0
Total Split (%)	37.5%	31.3%	31.3%	37.5%	31.3%	31.3%	18.8%	20.0%	20.0%	11.3%	12.5%	12.5%
Yellow Time (s)	4.0	5.0	5.0	4.0	5.0	5.0	4.0	5.0	5.0	4.0	5.0	5.0
All-Red Time (s)	2.0	2.0	2.0	2.0	2.0	2.0	2.0	2.0	2.0	2.0	2.0	2.0
Lost Time Adjust (s)	0.0	0.0	0.0	0.0	0.0	0.0	0.0	0.0	0.0	0.0	0.0	0.0
Total Lost Time (s)	6.0	7.0	7.0	6.0	7.0	7.0	6.0	7.0	7.0	6.0	7.0	7.0
Lead/Lag	Lead	Lag	Lag	Lead	Lag	Lag	Lead	Lag	Lag	Lead	Lag	Lag
Lead-Lag Optimize?	Yes	Yes	Yes	Yes	Yes	Yes	Yes	Yes	Yes	Yes	Yes	Yes
Recall Mode	None	C-Max	C-Max	None	C-Max	C-Max	None	None	None	None	None	None
Act Effct Green (s)	9.2	82.4	82.4	14.6	87.8	87.8	5.1	25.0	25.0	12.0	36.0	36.0
Actuated g/C Ratio	0.06	0.52	0.52	0.09	0.55	0.55	0.03	0.16	0.16	0.08	0.22	0.22
v/c Ratio	0.57	0.41	0.09	0.72	0.29	0.28	0.22	1.24	0.70	1.49	0.60	0.39
Control Delay	84.4	24.8	0.2	71.6	18.9	11.0	79.8	176.9	13.9	288.3	60.4	8.9
Queue Delay	0.0	0.0	0.0	0.0	0.0	0.0	0.0	0.0	0.0	0.0	0.0	0.0
Total Delay	84.4	24.8	0.2	71.6	18.9	11.0	79.8	176.9	13.9	288.3	60.4	8.9
LOS	F	C	A	E	B	B	E	F	B	F	E	A
Approach Delay		28.5			26.3			115.8			133.0	
Approach LOS		C			C			F			F	

Intersection Summary

Cycle Length: 160

Actuated Cycle Length: 160

Offset: 0 (0%), Referenced to phase 2:WBT and 6:EBT, Start of Yellow

Natural Cycle: 105

Control Type: Actuated-Coordinated

Maximum v/c Ratio: 1.49

Intersection Signal Delay: 71.6

Intersection LOS: E

Intersection Capacity Utilization 78.6%

ICU Level of Service D





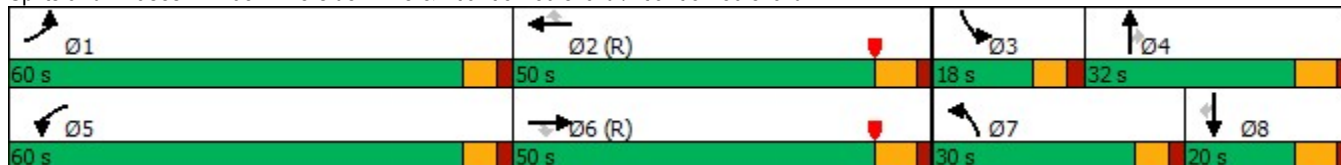







Analysis Period (min) 15

Splits and Phases: 105: Riverside Drive & Atlantic Boulevard /Atlantic Boulevard



Queues

105: Riverside Drive & Atlantic Boulevard /Atlantic Boulevard

												
Lane Group	EBL	EBT	EBR	WBL	WBT	WBR	NBL	NBT	NBR	SBL	SBT	SBR
Lane Group Flow (vph)	112	1074	80	227	818	279	24	686	403	384	479	200
v/c Ratio	0.57	0.41	0.09	0.72	0.29	0.28	0.22	1.24	0.70	1.49	0.60	0.39
Control Delay	84.4	24.8	0.2	71.6	18.9	11.0	79.8	176.9	13.9	288.3	60.4	8.9
Queue Delay	0.0	0.0	0.0	0.0	0.0	0.0	0.0	0.0	0.0	0.0	0.0	0.0
Total Delay	84.4	24.8	0.2	71.6	18.9	11.0	79.8	176.9	13.9	288.3	60.4	8.9
Queue Length 50th (ft)	59	247	0	100	283	177	12	~467	15	~285	247	0
Queue Length 95th (ft)	94	302	0	129	313	284	29	#598	130	#395	316	72
Internal Link Dist (ft)		1763			2560			1528			1193	
Turn Bay Length (ft)	250		300	220		270	300		300	300		300
Base Capacity (vph)	1158	2617	875	1158	2790	981	514	552	573	257	795	510
Starvation Cap Reductn	0	0	0	0	0	0	0	0	0	0	0	0
Spillback Cap Reductn	0	0	0	0	0	0	0	0	0	0	0	0
Storage Cap Reductn	0	0	0	0	0	0	0	0	0	0	0	0
Reduced v/c Ratio	0.10	0.41	0.09	0.20	0.29	0.28	0.05	1.24	0.70	1.49	0.60	0.39

Intersection Summary



































~ Volume exceeds capacity, queue is theoretically infinite.

Queue shown is maximum after two cycles.

95th percentile volume exceeds capacity, queue may be longer.

Queue shown is maximum after two cycles.

HCM 6th Signalized Intersection Summary
 105: Riverside Drive & Atlantic Boulevard /Atlantic Boulevard

												
Movement	EBL	EBT	EBR	WBL	WBT	WBR	NBL	NBT	NBR	SBL	SBT	SBR
Lane Configurations	 	  		  	  		 	 		 	 	
Traffic Volume (veh/h)	101	967	72	204	736	251	22	617	363	346	431	180
Future Volume (veh/h)	101	967	72	204	736	251	22	617	363	346	431	180
Initial Q (Qb), veh	0	0	0	0	0	0	0	0	0	0	0	0
Ped-Bike Adj(A_pbT)	1.00		1.00	1.00		1.00	1.00		1.00	1.00		1.00
Parking Bus, Adj	1.00	1.00	1.00	1.00	1.00	1.00	1.00	1.00	1.00	1.00	1.00	1.00
Work Zone On Approach		No			No			No			No	
Adj Sat Flow, veh/h/ln	1870	1870	1870	1870	1870	1870	1870	1870	1870	1870	1870	1870
Adj Flow Rate, veh/h	112	1074	80	227	818	279	24	686	403	384	479	200
Peak Hour Factor	0.90	0.90	0.90	0.90	0.90	0.90	0.90	0.90	0.90	0.90	0.90	0.90
Percent Heavy Veh, %	2	2	2	2	2	2	2	2	2	2	2	2
Cap, veh/h	155	2694	835	272	2867	889	57	555	248	259	764	341
Arrive On Green	0.06	0.70	0.70	0.10	0.75	0.75	0.02	0.16	0.16	0.08	0.21	0.21
Sat Flow, veh/h	3456	5106	1583	3456	5106	1583	3456	3554	1585	3456	3554	1585
Grp Volume(v), veh/h	112	1074	80	227	818	279	24	686	403	384	479	200
Grp Sat Flow(s),veh/h/ln	1728	1702	1583	1728	1702	1583	1728	1777	1585	1728	1777	1585
Q Serve(g_s), s	5.1	13.9	2.6	10.3	8.3	9.3	1.1	25.0	25.0	12.0	19.6	18.1
Cycle Q Clear(g_c), s	5.1	13.9	2.6	10.3	8.3	9.3	1.1	25.0	25.0	12.0	19.6	18.1
Prop In Lane	1.00		1.00	1.00		1.00	1.00		1.00	1.00		1.00
Lane Grp Cap(c), veh/h	155	2694	835	272	2867	889	57	555	248	259	764	341
V/C Ratio(X)	0.72	0.40	0.10	0.84	0.29	0.31	0.42	1.24	1.63	1.48	0.63	0.59
Avail Cap(c_a), veh/h	1166	2694	835	1166	2867	889	518	555	248	259	764	341
HCM Platoon Ratio	1.33	1.33	1.33	1.33	1.33	1.33	1.00	1.00	1.00	1.00	1.00	1.00
Upstream Filter(I)	1.00	1.00	1.00	0.93	0.93	0.93	1.00	1.00	1.00	1.00	1.00	1.00
Uniform Delay (d), s/veh	74.2	13.4	11.7	70.6	9.9	10.1	77.9	67.5	67.5	74.0	57.0	56.4
Incr Delay (d2), s/veh	2.4	0.4	0.2	2.4	0.2	0.9	1.9	120.9	300.0	236.3	1.2	1.8
Initial Q Delay(d3),s/veh	0.0	0.0	0.0	0.0	0.0	0.0	0.0	0.0	0.0	0.0	0.0	0.0
%ile BackOfQ(50%),veh/ln	2.3	4.8	1.0	4.6	2.9	3.2	0.5	20.7	30.8	13.9	9.0	7.5
Unsig. Movement Delay, s/veh												
LnGrp Delay(d),s/veh	76.6	13.8	11.9	73.0	10.2	10.9	79.8	188.4	367.5	310.3	58.2	58.2
LnGrp LOS	E	B	B	E	B	B	E	F	F	F	E	E
Approach Vol, veh/h		1266			1324			1113			1063	
Approach Delay, s/veh		19.2			21.1			250.9			149.3	
Approach LOS		B			C			F			F	
Timer - Assigned Phs	1	2	3	4	5	6	7	8				
Phs Duration (G+Y+Rc), s	13.2	96.8	18.0	32.0	18.6	91.4	8.6	41.4				
Change Period (Y+Rc), s	6.0	7.0	6.0	7.0	6.0	7.0	6.0	7.0				
Max Green Setting (Gmax), s	54.0	43.0	12.0	25.0	54.0	43.0	24.0	13.0				
Max Q Clear Time (g_c+I1), s	7.1	11.3	14.0	27.0	12.3	15.9	3.1	21.6				
Green Ext Time (p_c), s	0.1	7.9	0.0	0.0	0.3	9.2	0.0	0.0				
Intersection Summary												
HCM 6th Ctrl Delay			102.9									
HCM 6th LOS			F									
Notes												
User approved pedestrian interval to be less than phase max green.												

Timings

106: Ramblewood Drive & Atlantic Boulevard



Lane Group	EBL	EBT	WBL	WBT	NBL	NBT	NBR	SBL	SBT	SBR
Lane Configurations										
Traffic Volume (vph)	59	1557	29	1100	32	22	63	187	11	63
Future Volume (vph)	59	1557	29	1100	32	22	63	187	11	63
Turn Type	pm+pt	NA	pm+pt	NA	Perm	NA	Perm	Perm	NA	Perm
Protected Phases	1	6	5	2		4			8	
Permitted Phases	6		2		4		4	8		8
Detector Phase	1	6	5	2	4	4	4	8	8	8
Switch Phase										
Minimum Initial (s)	4.0	12.0	4.0	12.0	6.0	6.0	6.0	6.0	6.0	6.0
Minimum Split (s)	11.0	45.0	11.0	45.0	36.0	36.0	36.0	36.0	36.0	36.0
Total Split (s)	19.0	91.0	19.0	91.0	50.0	50.0	50.0	50.0	50.0	50.0
Total Split (%)	11.9%	56.9%	11.9%	56.9%	31.3%	31.3%	31.3%	31.3%	31.3%	31.3%
Yellow Time (s)	5.0	5.0	5.0	5.0	4.0	4.0	4.0	4.0	4.0	4.0
All-Red Time (s)	2.0	2.0	2.0	2.0	2.0	2.0	2.0	2.0	2.0	2.0
Lost Time Adjust (s)	0.0	0.0	0.0	0.0	0.0	0.0	0.0	0.0	0.0	0.0
Total Lost Time (s)	7.0	7.0	7.0	7.0	6.0	6.0	6.0	6.0	6.0	6.0
Lead/Lag	Lead	Lag	Lead	Lag						
Lead-Lag Optimize?	Yes	Yes	Yes	Yes						
Recall Mode	None	C-Max	None	C-Max	None	None	None	None	None	None
Act Effct Green (s)	112.8	107.9	109.6	104.7	29.5	29.5	29.5	29.5	29.5	29.5
Actuated g/C Ratio	0.70	0.67	0.68	0.65	0.18	0.18	0.18	0.18	0.18	0.18
v/c Ratio	0.25	0.51	0.18	0.41	0.14	0.04	0.20	0.82	0.03	0.20
Control Delay	4.8	6.1	9.6	14.5	52.5	49.8	9.7	86.3	49.4	9.7
Queue Delay	0.0	0.0	0.0	0.0	0.0	0.0	0.0	0.0	0.0	0.0
Total Delay	4.8	6.1	9.6	14.5	52.5	49.8	9.7	86.3	49.4	9.7
LOS	A	A	A	B	D	D	A	F	D	A
Approach Delay		6.1		14.4		29.0			66.3	
Approach LOS		A		B		C			E	

Intersection Summary

Cycle Length: 160

Actuated Cycle Length: 160

Offset: 83 (52%), Referenced to phase 2:WBTL and 6:EBTL, Start of Yellow

Natural Cycle: 95

Control Type: Actuated-Coordinated

Maximum v/c Ratio: 0.82

Intersection Signal Delay: 14.9

Intersection LOS: B

Intersection Capacity Utilization 69.2%

ICU Level of Service C

Analysis Period (min) 15

Splits and Phases: 106: Ramblewood Drive & Atlantic Boulevard

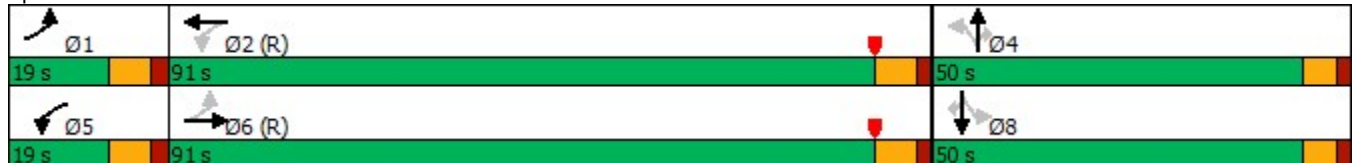

Queues

106: Ramblewood Drive & Atlantic Boulevard



Lane Group	EBL	EBT	WBL	WBT	NBL	NBT	NBR	SBL	SBT	SBR
Lane Group Flow (vph)	66	1748	32	1349	36	24	70	208	12	70
v/c Ratio	0.25	0.51	0.18	0.41	0.14	0.04	0.20	0.82	0.03	0.20
Control Delay	4.8	6.1	9.6	14.5	52.5	49.8	9.7	86.3	49.4	9.7
Queue Delay	0.0	0.0	0.0	0.0	0.0	0.0	0.0	0.0	0.0	0.0
Total Delay	4.8	6.1	9.6	14.5	52.5	49.8	9.7	86.3	49.4	9.7
Queue Length 50th (ft)	4	54	11	195	32	11	0	212	10	0
Queue Length 95th (ft)	m11	m386	25	213	63	23	39	291	28	39
Internal Link Dist (ft)		2560		3088		436			532	
Turn Bay Length (ft)	180		180		200		425	180		275
Base Capacity (vph)	331	3420	254	3287	383	973	484	379	512	483
Starvation Cap Reductn	0	0	0	0	0	0	0	0	0	0
Spillback Cap Reductn	0	0	0	0	0	0	0	0	0	0
Storage Cap Reductn	0	0	0	0	0	0	0	0	0	0
Reduced v/c Ratio	0.20	0.51	0.13	0.41	0.09	0.02	0.14	0.55	0.02	0.14

Intersection Summary

m Volume for 95th percentile queue is metered by upstream signal.

HCM 6th Signalized Intersection Summary

106: Ramblewood Drive & Atlantic Boulevard

Movement	EBL	EBT	EBR	WBL	WBT	WBR	NBL	NBT	NBR	SBL	SBT	SBR
Lane Configurations												
Traffic Volume (veh/h)	59	1557	16	29	1100	114	32	22	63	187	11	63
Future Volume (veh/h)	59	1557	16	29	1100	114	32	22	63	187	11	63
Initial Q (Qb), veh	0	0	0	0	0	0	0	0	0	0	0	0
Ped-Bike Adj(A_pbT)	1.00		0.98	1.00		1.00	1.00		0.98	1.00		1.00
Parking Bus, Adj	1.00	1.00	1.00	1.00	1.00	1.00	1.00	1.00	1.00	1.00	1.00	1.00
Work Zone On Approach		No			No			No			No	
Adj Sat Flow, veh/h/ln	1870	1870	1870	1870	1870	1870	1870	1870	1870	1870	1870	1870
Adj Flow Rate, veh/h	66	1730	18	32	1222	127	36	24	70	208	12	70
Peak Hour Factor	0.90	0.90	0.90	0.90	0.90	0.90	0.90	0.90	0.90	0.90	0.90	0.90
Percent Heavy Veh, %	2	2	2	2	2	2	2	2	2	2	2	2
Cap, veh/h	341	3515	37	248	3148	327	276	644	283	273	339	286
Arrive On Green	0.03	0.90	0.90	0.03	0.89	0.89	0.18	0.18	0.18	0.18	0.18	0.18
Sat Flow, veh/h	1781	5209	54	1781	4698	488	1312	3554	1559	1298	1870	1580
Grp Volume(v), veh/h	66	1130	618	32	885	464	36	24	70	208	12	70
Grp Sat Flow(s),veh/h/ln	1781	1702	1859	1781	1702	1782	1312	1777	1559	1298	1870	1580
Q Serve(g_s), s	1.9	9.8	9.8	0.9	6.9	6.9	3.7	0.9	6.2	25.2	0.8	6.1
Cycle Q Clear(g_c), s	1.9	9.8	9.8	0.9	6.9	6.9	4.6	0.9	6.2	26.1	0.8	6.1
Prop In Lane	1.00		0.03	1.00		0.27	1.00		1.00	1.00		1.00
Lane Grp Cap(c), veh/h	341	2297	1255	248	2281	1194	276	644	283	273	339	286
V/C Ratio(X)	0.19	0.49	0.49	0.13	0.39	0.39	0.13	0.04	0.25	0.76	0.04	0.24
Avail Cap(c_a), veh/h	432	2297	1255	348	2281	1194	399	977	429	395	514	434
HCM Platoon Ratio	1.33	1.33	1.33	1.33	1.33	1.33	1.00	1.00	1.00	1.00	1.00	1.00
Upstream Filter(l)	0.65	0.65	0.65	0.95	0.95	0.95	1.00	1.00	1.00	1.00	1.00	1.00
Uniform Delay (d), s/veh	7.9	3.2	3.2	8.1	3.2	3.2	55.9	54.0	56.2	64.7	54.0	56.1
Incr Delay (d2), s/veh	0.1	0.5	0.9	0.1	0.5	0.9	0.2	0.0	0.5	5.2	0.0	0.4
Initial Q Delay(d3),s/veh	0.0	0.0	0.0	0.0	0.0	0.0	0.0	0.0	0.0	0.0	0.0	0.0
%ile BackOfQ(50%),veh/ln	0.7	2.5	2.8	0.4	2.0	2.3	1.3	0.4	2.5	8.7	0.4	2.5
Unsig. Movement Delay, s/veh												
LnGrp Delay(d),s/veh	8.0	3.7	4.1	8.2	3.7	4.2	56.1	54.0	56.6	69.9	54.0	56.6
LnGrp LOS	A	A	A	A	A	A	E	D	E	E	D	E
Approach Vol, veh/h		1814			1381			130			290	
Approach Delay, s/veh		4.0			4.0			56.0			66.0	
Approach LOS		A			A			E			E	
Timer - Assigned Phs	1	2		4	5	6		8				
Phs Duration (G+Y+Rc), s	10.8	114.2		35.0	10.0	115.0		35.0				
Change Period (Y+Rc), s	7.0	7.0		6.0	7.0	7.0		6.0				
Max Green Setting (Gmax), s	12.0	84.0		44.0	12.0	84.0		44.0				
Max Q Clear Time (g_c+I1), s	3.9	8.9		8.2	2.9	11.8		28.1				
Green Ext Time (p_c), s	0.0	14.0		0.5	0.0	22.3		0.8				
Intersection Summary												
HCM 6th Ctrl Delay				10.8								
HCM 6th LOS				B								

Timings

107: NW 76 Avenue & Atlantic Boulevard



Lane Group	EBL	EBT	WBL	WBT	NBL	NBT	SBL	SBT	SBR
Lane Configurations	↖	↕↕↕↗	↖	↕↕↕↗	↖	↗	↖	↕	↗
Traffic Volume (vph)	64	1817	6	997	34	13	109	24	168
Future Volume (vph)	64	1817	6	997	34	13	109	24	168
Turn Type	Prot	NA	Prot	NA	Perm	NA	Perm	NA	Perm
Protected Phases	1	6	5	2		4		8	
Permitted Phases					4		8		8
Detector Phase	1	6	5	2	4	4	8	8	8
Switch Phase									
Minimum Initial (s)	4.0	12.0	4.0	12.0	6.0	6.0	6.0	6.0	6.0
Minimum Split (s)	24.0	28.0	10.0	28.0	43.0	43.0	43.0	43.0	43.0
Total Split (s)	25.0	100.0	16.0	91.0	44.0	44.0	44.0	44.0	44.0
Total Split (%)	15.6%	62.5%	10.0%	56.9%	27.5%	27.5%	27.5%	27.5%	27.5%
Yellow Time (s)	4.0	4.0	4.0	4.0	4.0	4.0	4.0	4.0	4.0
All-Red Time (s)	2.0	2.0	2.0	2.0	2.0	2.0	2.0	2.0	2.0
Lost Time Adjust (s)	0.0	0.0	0.0	0.0	0.0	0.0	0.0	0.0	0.0
Total Lost Time (s)	6.0	6.0	6.0	6.0	6.0	6.0	6.0	6.0	6.0
Lead/Lag	Lead	Lag	Lead	Lag					
Lead-Lag Optimize?	Yes	Yes	Yes	Yes					
Recall Mode	None	C-Max	None	C-Max	None	None	None	None	None
Act Effct Green (s)	10.0	127.8	4.7	114.2	17.8	17.8	17.8	17.8	17.8
Actuated g/C Ratio	0.06	0.80	0.03	0.71	0.11	0.11	0.11	0.11	0.11
v/c Ratio	0.61	0.48	0.12	0.31	0.23	0.17	0.75	0.12	0.53
Control Delay	95.1	8.2	68.7	7.9	65.8	34.1	96.7	62.3	13.9
Queue Delay	0.0	0.0	0.0	0.0	0.0	0.0	0.0	0.0	0.0
Total Delay	95.1	8.2	68.7	7.9	65.8	34.1	96.7	62.3	13.9
LOS	F	A	E	A	E	C	F	E	B
Approach Delay		11.0		8.2		50.2		47.8	
Approach LOS		B		A		D		D	

Intersection Summary

Cycle Length: 160

Actuated Cycle Length: 160

Offset: 138 (86%), Referenced to phase 2:WBT and 6:EBT, Start of Yellow

Natural Cycle: 95

Control Type: Actuated-Coordinated

Maximum v/c Ratio: 0.75

Intersection Signal Delay: 14.2

Intersection LOS: B

Intersection Capacity Utilization 68.6%

ICU Level of Service C

Analysis Period (min) 15

Splits and Phases: 107: NW 76 Avenue & Atlantic Boulevard

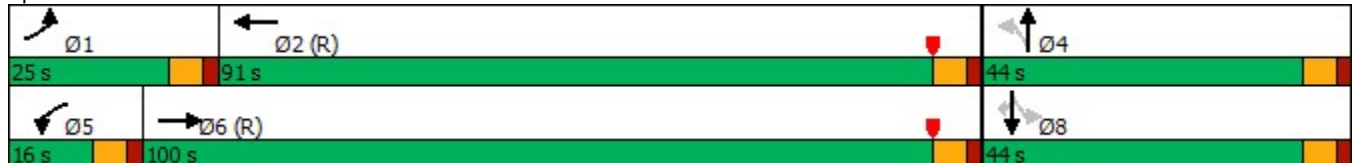

Queues

107: NW 76 Avenue & Atlantic Boulevard



Lane Group	EBL	EBT	WBL	WBT	NBL	NBT	SBL	SBT	SBR
Lane Group Flow (vph)	67	1951	6	1107	35	34	114	25	175
v/c Ratio	0.61	0.48	0.12	0.31	0.23	0.17	0.75	0.12	0.53
Control Delay	95.1	8.2	68.7	7.9	65.8	34.1	96.7	62.3	13.9
Queue Delay	0.0	0.0	0.0	0.0	0.0	0.0	0.0	0.0	0.0
Total Delay	95.1	8.2	68.7	7.9	65.8	34.1	96.7	62.3	13.9
Queue Length 50th (ft)	70	220	6	124	34	13	118	24	0
Queue Length 95th (ft)	128	267	m13	m153	69	47	182	53	71
Internal Link Dist (ft)		3088		2032		396		487	
Turn Bay Length (ft)	150		200		225		200		200
Base Capacity (vph)	210	4043	110	3593	327	414	323	442	503
Starvation Cap Reductn	0	0	0	0	0	0	0	0	0
Spillback Cap Reductn	0	0	0	0	0	0	0	0	0
Storage Cap Reductn	0	0	0	0	0	0	0	0	0
Reduced v/c Ratio	0.32	0.48	0.05	0.31	0.11	0.08	0.35	0.06	0.35

Intersection Summary

m Volume for 95th percentile queue is metered by upstream signal.

HCM 6th Signalized Intersection Summary

107: NW 76 Avenue & Atlantic Boulevard

Movement	EBL	EBT	EBR	WBL	WBT	WBR	NBL	NBT	NBR	SBL	SBT	SBR
Lane Configurations												
Traffic Volume (veh/h)	64	1817	56	6	997	65	34	13	19	109	24	168
Future Volume (veh/h)	64	1817	56	6	997	65	34	13	19	109	24	168
Initial Q (Qb), veh	0	0	0	0	0	0	0	0	0	0	0	0
Ped-Bike Adj(A_pbT)	1.00		1.00	1.00		1.00	1.00		0.98	0.99		0.98
Parking Bus, Adj	1.00	1.00	1.00	1.00	1.00	1.00	1.00	1.00	1.00	1.00	1.00	1.00
Work Zone On Approach		No			No			No			No	
Adj Sat Flow, veh/h/ln	1870	1870	1870	1870	1870	1870	1870	1870	1870	1870	1870	1870
Adj Flow Rate, veh/h	67	1893	58	6	1039	68	35	14	20	114	25	175
Peak Hour Factor	0.96	0.96	0.96	0.96	0.96	0.96	0.96	0.96	0.96	0.96	0.96	0.96
Percent Heavy Veh, %	2	2	2	2	2	2	2	2	2	2	2	2
Cap, veh/h	88	3782	116	10	3423	224	194	95	136	210	259	215
Arrive On Green	0.07	0.99	0.99	0.01	0.93	0.93	0.14	0.14	0.14	0.14	0.14	0.14
Sat Flow, veh/h	1781	5090	156	1781	4896	320	1177	688	982	1367	1870	1553
Grp Volume(v), veh/h	67	1265	686	6	722	385	35	0	34	114	25	175
Grp Sat Flow(s),veh/h/ln	1781	1702	1842	1781	1702	1812	1177	0	1670	1367	1870	1553
Q Serve(g_s), s	5.9	1.4	1.4	0.5	3.3	3.3	4.3	0.0	2.9	12.8	1.9	17.5
Cycle Q Clear(g_c), s	5.9	1.4	1.4	0.5	3.3	3.3	6.1	0.0	2.9	15.7	1.9	17.5
Prop In Lane	1.00		0.08	1.00		0.18	1.00		0.59	1.00		1.00
Lane Grp Cap(c), veh/h	88	2529	1369	10	2380	1267	194	0	231	210	259	215
V/C Ratio(X)	0.76	0.50	0.50	0.58	0.30	0.30	0.18	0.00	0.15	0.54	0.10	0.81
Avail Cap(c_a), veh/h	212	2529	1369	111	2380	1267	311	0	397	345	444	369
HCM Platoon Ratio	1.33	1.33	1.33	1.33	1.33	1.33	1.00	1.00	1.00	1.00	1.00	1.00
Upstream Filter(I)	0.83	0.83	0.83	0.83	0.83	0.83	1.00	0.00	1.00	1.00	1.00	1.00
Uniform Delay (d), s/veh	73.8	0.3	0.3	79.2	1.8	1.8	62.8	0.0	60.6	67.5	60.2	66.9
Incr Delay (d2), s/veh	4.1	0.6	1.1	14.5	0.3	0.5	0.2	0.0	0.1	0.8	0.1	2.8
Initial Q Delay(d3),s/veh	0.0	0.0	0.0	0.0	0.0	0.0	0.0	0.0	0.0	0.0	0.0	0.0
%ile BackOfQ(50%),veh/ln	2.8	0.5	0.7	0.3	1.0	1.2	1.3	0.0	1.2	4.5	0.9	7.1
Unsig. Movement Delay, s/veh												
LnGrp Delay(d),s/veh	77.8	0.8	1.3	93.6	2.1	2.3	63.0	0.0	60.7	68.3	60.2	69.7
LnGrp LOS	E	A	A	F	A	A	E	A	E	E	E	E
Approach Vol, veh/h		2018			1113			69			314	
Approach Delay, s/veh		3.6			2.7			61.9			68.4	
Approach LOS		A			A			E			E	
Timer - Assigned Phs	1	2		4	5	6		8				
Phs Duration (G+Y+Rc), s	13.9	117.9		28.2	6.9	124.9		28.2				
Change Period (Y+Rc), s	6.0	6.0		6.0	6.0	6.0		6.0				
Max Green Setting (Gmax), s	19.0	85.0		38.0	10.0	94.0		38.0				
Max Q Clear Time (g_c+I1), s	7.9	5.3		8.1	2.5	3.4		19.5				
Green Ext Time (p_c), s	0.0	10.1		0.2	0.0	29.6		0.5				
Intersection Summary												
HCM 6th Ctrl Delay				10.2								
HCM 6th LOS				B								

Timings

108: Rock Island Road & Atlantic Boulevard/Atlantic Boulevard



Lane Group	EBL	EBT	WBL	WBT	NBL	NBT	NBR	SBL	SBT
Lane Configurations									
Traffic Volume (vph)	146	1314	277	719	282	923	470	184	867
Future Volume (vph)	146	1314	277	719	282	923	470	184	867
Turn Type	Prot	NA	Prot	NA	Prot	NA	Perm	Prot	NA
Protected Phases	1	6	5	2	7	4		3	8
Permitted Phases							4		
Detector Phase	1	6	5	2	7	4	4	3	8
Switch Phase									
Minimum Initial (s)	5.0	12.0	5.0	12.0	5.0	6.0	6.0	5.0	6.0
Minimum Split (s)	11.0	49.0	11.0	49.0	11.5	51.5	51.5	11.5	51.5
Total Split (s)	26.0	58.0	26.0	58.0	24.0	52.0	52.0	24.0	52.0
Total Split (%)	16.3%	36.3%	16.3%	36.3%	15.0%	32.5%	32.5%	15.0%	32.5%
Yellow Time (s)	4.0	4.0	4.0	4.0	4.5	4.5	4.5	4.5	4.5
All-Red Time (s)	2.0	2.0	2.0	2.0	2.0	2.0	2.0	2.0	2.0
Lost Time Adjust (s)	0.0	0.0	0.0	0.0	0.0	0.0	0.0	0.0	0.0
Total Lost Time (s)	6.0	6.0	6.0	6.0	6.5	6.5	6.5	6.5	6.5
Lead/Lag	Lead	Lag	Lead	Lag	Lead	Lag	Lag	Lead	Lag
Lead-Lag Optimize?	Yes	Yes	Yes	Yes	Yes	Yes	Yes	Yes	Yes
Recall Mode	None	C-Max	None	C-Max	None	None	None	None	None
Act Effct Green (s)	10.9	55.2	16.8	61.1	16.2	50.3	50.3	12.7	46.8
Actuated g/C Ratio	0.07	0.34	0.10	0.38	0.10	0.31	0.31	0.08	0.29
v/c Ratio	0.65	0.95	0.79	0.43	0.84	0.86	0.85	0.70	0.99
Control Delay	90.2	70.0	66.7	67.8	79.1	45.0	36.9	64.5	82.2
Queue Delay	0.0	0.0	0.0	0.0	0.0	0.0	0.0	0.0	0.0
Total Delay	90.2	70.0	66.7	67.8	79.1	45.0	36.9	64.5	82.2
LOS	F	E	E	E	E	D	D	E	F
Approach Delay		71.7		67.5		48.5			79.4
Approach LOS		E		E		D			E

Intersection Summary

Cycle Length: 160
 Actuated Cycle Length: 160
 Offset: 100 (63%), Referenced to phase 2:WBT and 6:EBT, Start of Yellow
 Natural Cycle: 135
 Control Type: Actuated-Coordinated
 Maximum v/c Ratio: 0.99
 Intersection Signal Delay: 65.6
 Intersection LOS: E
 Intersection Capacity Utilization 100.6%
 ICU Level of Service G
 Analysis Period (min) 15

Splits and Phases: 108: Rock Island Road & Atlantic Boulevard/Atlantic Boulevard

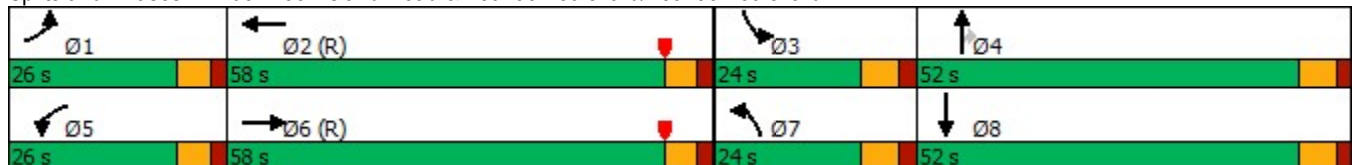

Queues

108: Rock Island Road & Atlantic Boulevard/Atlantic Boulevard



Lane Group	EBL	EBT	WBL	WBT	NBL	NBT	NBR	SBL	SBT
Lane Group Flow (vph)	151	1644	286	831	291	952	485	190	1014
v/c Ratio	0.65	0.95	0.79	0.43	0.84	0.86	0.85	0.70	0.99
Control Delay	90.2	70.0	66.7	67.8	79.1	45.0	36.9	64.5	82.2
Queue Delay	0.0	0.0	0.0	0.0	0.0	0.0	0.0	0.0	0.0
Total Delay	90.2	70.0	66.7	67.8	79.1	45.0	36.9	64.5	82.2
Queue Length 50th (ft)	85	435	158	318	161	520	413	97	~596
Queue Length 95th (ft)	124	#550	m184	m370	m180	m538	m455	m136	#738
Internal Link Dist (ft)		2032		5200		2618			3616
Turn Bay Length (ft)	300		300		210		23	200	
Base Capacity (vph)	429	1725	429	1915	375	1111	570	375	1021
Starvation Cap Reductn	0	0	0	0	0	0	0	0	0
Spillback Cap Reductn	0	0	0	0	0	0	0	0	0
Storage Cap Reductn	0	0	0	0	0	0	0	0	0
Reduced v/c Ratio	0.35	0.95	0.67	0.43	0.78	0.86	0.85	0.51	0.99

Intersection Summary

~ Volume exceeds capacity, queue is theoretically infinite.

































Queue shown is maximum after two cycles.

95th percentile volume exceeds capacity, queue may be longer.

Queue shown is maximum after two cycles.

m Volume for 95th percentile queue is metered by upstream signal.

HCM 6th Signalized Intersection Summary
 108: Rock Island Road & Atlantic Boulevard/Atlantic Boulevard

												
Movement	EBL	EBT	EBR	WBL	WBT	WBR	NBL	NBT	NBR	SBL	SBT	SBR
Lane Configurations	 	  		 	  		 	 		 	 	 
Traffic Volume (veh/h)	146	1314	280	277	719	87	282	923	470	184	867	116
Future Volume (veh/h)	146	1314	280	277	719	87	282	923	470	184	867	116
Initial Q (Qb), veh	0	0	0	0	0	0	0	0	0	0	0	0
Ped-Bike Adj(A_pbT)	1.00		0.99	1.00		1.00	1.00		1.00	1.00		0.99
Parking Bus, Adj	1.00	1.00	1.00	1.00	1.00	1.00	1.00	1.00	1.00	1.00	1.00	1.00
Work Zone On Approach		No			No			No			No	
Adj Sat Flow, veh/h/ln	1870	1870	1870	1870	1870	1870	1870	1870	1870	1870	1870	1870
Adj Flow Rate, veh/h	151	1355	289	286	741	90	291	952	485	190	894	120
Peak Hour Factor	0.97	0.97	0.97	0.97	0.97	0.97	0.97	0.97	0.97	0.97	0.97	0.97
Percent Heavy Veh, %	2	2	2	2	2	2	2	2	2	2	2	2
Cap, veh/h	194	1545	329	328	1876	226	335	1115	497	233	894	120
Arrive On Green	0.07	0.49	0.49	0.13	0.54	0.54	0.03	0.10	0.10	0.07	0.28	0.28
Sat Flow, veh/h	3456	4203	895	3456	4617	557	3456	3554	1584	3456	3142	422
Grp Volume(v), veh/h	151	1097	547	286	545	286	291	952	485	190	506	508
Grp Sat Flow(s),veh/h/ln	1728	1702	1694	1728	1702	1769	1728	1777	1584	1728	1777	1787
Q Serve(g_s), s	6.9	46.1	46.3	13.0	15.0	15.1	13.4	42.2	48.9	8.7	45.5	45.5
Cycle Q Clear(g_c), s	6.9	46.1	46.3	13.0	15.0	15.1	13.4	42.2	48.9	8.7	45.5	45.5
Prop In Lane	1.00		0.53	1.00		0.31	1.00		1.00	1.00		0.24
Lane Grp Cap(c), veh/h	194	1251	623	328	1383	719	335	1115	497	233	505	508
V/C Ratio(X)	0.78	0.88	0.88	0.87	0.39	0.40	0.87	0.85	0.98	0.81	1.00	1.00
Avail Cap(c_a), veh/h	432	1251	623	432	1383	719	378	1115	497	378	505	508
HCM Platoon Ratio	1.33	1.33	1.33	1.33	1.33	1.33	0.33	0.33	0.33	1.00	1.00	1.00
Upstream Filter(I)	0.86	0.86	0.86	0.36	0.36	0.36	0.12	0.12	0.12	0.90	0.90	0.90
Uniform Delay (d), s/veh	73.0	37.7	37.7	68.9	25.3	25.3	76.4	68.1	71.1	73.6	57.3	57.3
Incr Delay (d2), s/veh	2.2	7.7	14.2	4.7	0.3	0.6	2.4	0.8	9.2	2.5	38.1	38.0
Initial Q Delay(d3),s/veh	0.0	0.0	0.0	0.0	0.0	0.0	0.0	0.0	0.0	0.0	0.0	0.0
%ile BackOfQ(50%),veh/ln	3.1	19.5	20.5	5.8	5.8	6.2	6.4	20.4	22.2	4.0	25.8	25.9
Unsig. Movement Delay, s/veh												
LnGrp Delay(d),s/veh	75.2	45.4	51.9	73.7	25.6	25.9	78.8	68.9	80.3	76.1	95.3	95.3
LnGrp LOS	E	D	D	E	C	C	E	E	F	E	F	F
Approach Vol, veh/h		1795			1117			1728			1204	
Approach Delay, s/veh		49.9			38.0			73.8			92.3	
Approach LOS		D			D			E			F	
Timer - Assigned Phs	1	2	3	4	5	6	7	8				
Phs Duration (G+Y+Rc), s	15.0	71.0	17.3	56.7	21.2	64.8	22.0	52.0				
Change Period (Y+Rc), s	6.0	6.0	6.5	6.5	6.0	6.0	6.5	6.5				
Max Green Setting (Gmax), s	20.0	52.0	17.5	45.5	20.0	52.0	17.5	45.5				
Max Q Clear Time (g_c+I1), s	8.9	17.1	10.7	50.9	15.0	48.3	15.4	47.5				
Green Ext Time (p_c), s	0.1	6.4	0.1	0.0	0.2	3.0	0.1	0.0				
Intersection Summary												
HCM 6th Ctrl Delay			63.4									
HCM 6th LOS			E									

Timings

109: SR 7 & Atlantic Boulevard

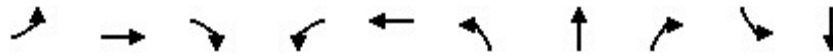

Lane Group	EBL	EBT	EBR	WBL	WBT	NBL	NBT	NBR	SBL	SBT
Lane Configurations	↔↔	↑↑↑	↗	↔↔	↑↑↑	↗	↑↑↑	↗	↗	↑↑↑
Traffic Volume (vph)	474	1402	195	296	787	122	1629	542	272	1288
Future Volume (vph)	474	1402	195	296	787	122	1629	542	272	1288
Turn Type	Prot	NA	Perm	Prot	NA	Prot	NA	Perm	Prot	NA
Protected Phases	7	4		3	8	5	2		1	6
Permitted Phases			4					2		
Detector Phase	7	4	4	3	8	5	2	2	1	6
Switch Phase										
Minimum Initial (s)	4.0	6.0	6.0	4.0	6.0	5.0	8.0	8.0	5.0	8.0
Minimum Split (s)	11.0	47.0	47.0	11.0	43.0	12.0	50.0	50.0	12.0	50.0
Total Split (s)	31.0	53.0	53.0	21.0	43.0	19.0	57.0	57.0	29.0	67.0
Total Split (%)	19.4%	33.1%	33.1%	13.1%	26.9%	11.9%	35.6%	35.6%	18.1%	41.9%
Yellow Time (s)	5.0	5.0	5.0	5.0	5.0	5.0	5.0	5.0	5.0	5.0
All-Red Time (s)	2.0	2.0	2.0	2.0	2.0	2.0	2.0	2.0	2.0	2.0
Lost Time Adjust (s)	0.0	0.0	0.0	0.0	0.0	0.0	0.0	0.0	0.0	0.0
Total Lost Time (s)	7.0	7.0	7.0	7.0	7.0	7.0	7.0	7.0	7.0	7.0
Lead/Lag	Lead	Lag	Lag	Lead	Lag	Lead	Lag	Lag	Lead	Lag
Lead-Lag Optimize?	Yes	Yes	Yes	Yes	Yes	Yes	Yes	Yes	Yes	Yes
Recall Mode	None	None	None	None	None	None	C-Max	C-Max	None	C-Max
Act Effct Green (s)	23.8	46.0	46.0	14.0	36.2	12.0	50.0	50.0	22.0	60.0
Actuated g/C Ratio	0.15	0.29	0.29	0.09	0.23	0.08	0.31	0.31	0.14	0.38
v/c Ratio	0.96	0.99	0.35	1.02	0.87	0.95	1.06	0.86	1.15	0.79
Control Delay	100.1	75.5	19.3	126.2	67.2	138.5	91.2	42.6	167.2	47.4
Queue Delay	0.0	0.0	0.0	0.0	0.0	0.0	0.0	0.0	0.0	0.0
Total Delay	100.1	75.5	19.3	126.2	67.2	138.5	91.2	42.6	167.2	47.4
LOS	F	E	B	F	E	F	F	D	F	D
Approach Delay		75.8			81.1		82.2			66.3
Approach LOS		E			F		F			E

Intersection Summary

Cycle Length: 160	
Actuated Cycle Length: 160	
Offset: 115 (72%), Referenced to phase 2:NBT and 6:SBT, Start of Yellow	
Natural Cycle: 150	
Control Type: Actuated-Coordinated	
Maximum v/c Ratio: 1.15	
Intersection Signal Delay: 76.5	Intersection LOS: E
Intersection Capacity Utilization 110.0%	ICU Level of Service H
Analysis Period (min) 15	

Splits and Phases: 109: SR 7 & Atlantic Boulevard

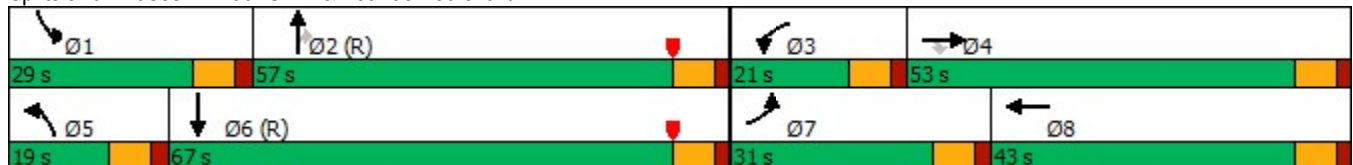

Queues

109: SR 7 & Atlantic Boulevard

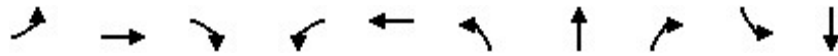

Lane Group	EBL	EBT	EBR	WBL	WBT	NBL	NBT	NBR	SBL	SBT
Lane Group Flow (vph)	489	1445	201	305	989	126	1679	559	280	1491
v/c Ratio	0.96	0.99	0.35	1.02	0.87	0.95	1.06	0.86	1.15	0.79
Control Delay	100.1	75.5	19.3	126.2	67.2	138.5	91.2	42.6	167.2	47.4
Queue Delay	0.0	0.0	0.0	0.0	0.0	0.0	0.0	0.0	0.0	0.0
Total Delay	100.1	75.5	19.3	126.2	67.2	138.5	91.2	42.6	167.2	47.4
Queue Length 50th (ft)	278	477	39	~173	360	134	~702	342	~350	310
Queue Length 95th (ft)	m#322	m#625	m64	#275	419	#274	#797	#558	#551	465
Internal Link Dist (ft)		5200			1156		610			2153
Turn Bay Length (ft)	275		350	520		400		260	400	
Base Capacity (vph)	514	1461	572	300	1137	132	1589	653	243	1881
Starvation Cap Reductn	0	0	0	0	0	0	0	0	0	0
Spillback Cap Reductn	0	0	0	0	0	0	0	0	0	0
Storage Cap Reductn	0	0	0	0	0	0	0	0	0	0
Reduced v/c Ratio	0.95	0.99	0.35	1.02	0.87	0.95	1.06	0.86	1.15	0.79

Intersection Summary

~ Volume exceeds capacity, queue is theoretically infinite.

Queue shown is maximum after two cycles.



































95th percentile volume exceeds capacity, queue may be longer.

Queue shown is maximum after two cycles.

m Volume for 95th percentile queue is metered by upstream signal.

HCM 6th Signalized Intersection Summary

109: SR 7 & Atlantic Boulevard

												
Movement	EBL	EBT	EBR	WBL	WBT	WBR	NBL	NBT	NBR	SBL	SBT	SBR
Lane Configurations	 	  		 	  			  		  	  	
Traffic Volume (veh/h)	474	1402	195	296	787	173	122	1629	542	272	1288	158
Future Volume (veh/h)	474	1402	195	296	787	173	122	1629	542	272	1288	158
Initial Q (Qb), veh	0	0	0	0	0	0	0	0	0	0	0	0
Ped-Bike Adj(A_pbT)	1.00		1.00	1.00		1.00	1.00		0.99	1.00		0.99
Parking Bus, Adj	1.00	1.00	1.00	1.00	1.00	1.00	1.00	1.00	1.00	1.00	1.00	1.00
Work Zone On Approach		No			No			No			No	
Adj Sat Flow, veh/h/ln	1870	1870	1870	1870	1870	1870	1870	1870	1870	1870	1870	1870
Adj Flow Rate, veh/h	489	1445	201	305	811	178	126	1679	559	280	1328	163
Peak Hour Factor	0.97	0.97	0.97	0.97	0.97	0.97	0.97	0.97	0.97	0.97	0.97	0.97
Percent Heavy Veh, %	2	2	2	2	2	2	2	2	2	2	2	2
Cap, veh/h	518	1468	454	302	943	205	134	1596	492	245	1726	212
Arrive On Green	0.15	0.29	0.29	0.09	0.22	0.22	0.10	0.42	0.42	0.18	0.50	0.50
Sat Flow, veh/h	3456	5106	1580	3456	4193	913	1781	5106	1574	1781	4604	565
Grp Volume(v), veh/h	489	1445	201	305	657	332	126	1679	559	280	982	509
Grp Sat Flow(s),veh/h/ln	1728	1702	1580	1728	1702	1702	1781	1702	1574	1781	1702	1765
Q Serve(g_s), s	22.4	45.0	16.6	14.0	29.7	30.0	11.2	50.0	50.0	22.0	37.5	37.5
Cycle Q Clear(g_c), s	22.4	45.0	16.6	14.0	29.7	30.0	11.2	50.0	50.0	22.0	37.5	37.5
Prop In Lane	1.00		1.00	1.00		0.54	1.00		1.00	1.00		0.32
Lane Grp Cap(c), veh/h	518	1468	454	302	766	383	134	1596	492	245	1277	662
V/C Ratio(X)	0.94	0.98	0.44	1.01	0.86	0.87	0.94	1.05	1.14	1.14	0.77	0.77
Avail Cap(c_a), veh/h	518	1468	454	302	766	383	134	1596	492	245	1277	662
HCM Platoon Ratio	1.00	1.00	1.00	1.00	1.00	1.00	1.33	1.33	1.33	1.33	1.33	1.33
Upstream Filter(I)	0.29	0.29	0.29	1.00	1.00	1.00	1.00	1.00	1.00	0.81	0.81	0.81
Uniform Delay (d), s/veh	67.3	56.6	46.5	73.0	59.5	59.7	71.7	46.8	46.8	65.4	34.5	34.5
Incr Delay (d2), s/veh	10.6	9.4	0.1	54.0	9.4	18.2	59.9	37.7	83.6	96.3	3.7	6.9
Initial Q Delay(d3),s/veh	0.0	0.0	0.0	0.0	0.0	0.0	0.0	0.0	0.0	0.0	0.0	0.0
%ile BackOfQ(50%),veh/ln	10.7	20.6	6.6	8.5	13.8	14.9	7.3	25.7	30.1	16.3	15.3	16.5
Unsig. Movement Delay, s/veh												
LnGrp Delay(d),s/veh	77.9	66.0	46.7	127.0	69.0	77.8	131.6	84.4	130.4	161.6	38.1	41.4
LnGrp LOS	E	E	D	F	E	E	F	F	F	F	D	D
Approach Vol, veh/h		2135			1294			2364			1771	
Approach Delay, s/veh		66.9			84.9			97.8			58.6	
Approach LOS		E			F			F			E	
Timer - Assigned Phs	1	2	3	4	5	6	7	8				
Phs Duration (G+Y+Rc), s	29.0	57.0	21.0	53.0	19.0	67.0	31.0	43.0				
Change Period (Y+Rc), s	7.0	7.0	7.0	7.0	7.0	7.0	7.0	7.0				
Max Green Setting (Gmax), s	22.0	50.0	14.0	46.0	12.0	60.0	24.0	36.0				
Max Q Clear Time (g_c+I1), s	24.0	52.0	16.0	47.0	13.2	39.5	24.4	32.0				
Green Ext Time (p_c), s	0.0	0.0	0.0	0.0	0.0	10.9	0.0	2.0				
Intersection Summary												
HCM 6th Ctrl Delay				77.7								
HCM 6th LOS				E								
Notes												
User approved pedestrian interval to be less than phase max green.												

Timings

110: Southgate Boulevard & Rock Island Road

Lane Group	EBL	EBT	EBR	WBL	WBT	NBL	NBT	NBR	SBL	SBT	SBR
Lane Configurations											
Traffic Volume (vph)	553	720	167	38	483	169	961	112	288	864	441
Future Volume (vph)	553	720	167	38	483	169	961	112	288	864	441
Turn Type	Prot	NA	Perm	Prot	NA	pm+pt	NA	Perm	pm+pt	NA	Perm
Protected Phases	7	4		3	8	5	2		1	6	
Permitted Phases			4			2		2	6		6
Detector Phase	7	4	4	3	8	5	2	2	1	6	6
Switch Phase											
Minimum Initial (s)	5.0	6.0	6.0	5.0	6.0	4.0	12.0	12.0	4.0	12.0	12.0
Minimum Split (s)	11.5	36.5	36.5	11.5	47.5	10.5	44.5	44.5	10.5	44.5	44.5
Total Split (s)	26.0	49.0	49.0	26.0	49.0	19.0	66.0	66.0	19.0	66.0	66.0
Total Split (%)	16.3%	30.6%	30.6%	16.3%	30.6%	11.9%	41.3%	41.3%	11.9%	41.3%	41.3%
Yellow Time (s)	4.5	4.5	4.5	4.5	4.5	4.5	4.5	4.5	4.5	4.5	4.5
All-Red Time (s)	2.0	2.0	2.0	2.0	2.0	2.0	2.0	2.0	2.0	2.0	2.0
Lost Time Adjust (s)	0.0	0.0	0.0	0.0	0.0	0.0	0.0	0.0	0.0	0.0	0.0
Total Lost Time (s)	6.5	6.5	6.5	6.5	6.5	6.5	6.5	6.5	6.5	6.5	6.5
Lead/Lag	Lead	Lag	Lag	Lead	Lag	Lead	Lag	Lag	Lead	Lag	Lag
Lead-Lag Optimize?	Yes	Yes	Yes	Yes	Yes	Yes	Yes	Yes	Yes	Yes	Yes
Recall Mode	None	None	None	None	None	None	C-Max	C-Max	None	C-Max	C-Max
Act Effct Green (s)	19.5	53.7	53.7	7.7	39.7	70.9	59.5	59.5	77.3	63.4	63.4
Actuated g/C Ratio	0.12	0.34	0.34	0.05	0.25	0.44	0.37	0.37	0.48	0.40	0.40
v/c Ratio	1.38	0.63	0.29	0.47	0.91	0.70	0.76	0.18	1.22	0.64	0.58
Control Delay	233.5	48.1	16.0	91.2	68.1	38.3	48.6	6.7	164.0	43.5	21.7
Queue Delay	0.0	0.0	0.0	0.0	0.0	0.0	0.0	0.0	0.0	0.0	0.0
Total Delay	233.5	48.1	16.0	91.2	68.1	38.3	48.6	6.7	164.0	43.5	21.7
LOS	F	D	B	F	E	D	D	A	F	D	C
Approach Delay		115.5			69.2		43.4			59.2	
Approach LOS		F			E		D			E	

Intersection Summary

Cycle Length: 160

Actuated Cycle Length: 160

Offset: 60 (38%), Referenced to phase 2:NBTL and 6:SBTL, Start of Yellow

Natural Cycle: 145

Control Type: Actuated-Coordinated

Maximum v/c Ratio: 1.38

Intersection Signal Delay: 72.9

Intersection LOS: E

Intersection Capacity Utilization 108.2%

ICU Level of Service G

Analysis Period (min) 15

Splits and Phases: 110: Southgate Boulevard & Rock Island Road

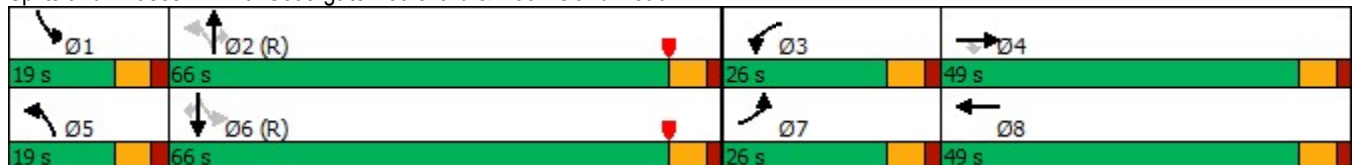

Queues

110: Southgate Boulevard & Rock Island Road



Lane Group	EBL	EBT	EBR	WBL	WBT	NBL	NBT	NBR	SBL	SBT	SBR
Lane Group Flow (vph)	576	750	174	40	806	176	1001	117	300	900	459
v/c Ratio	1.38	0.63	0.29	0.47	0.91	0.70	0.76	0.18	1.22	0.64	0.58
Control Delay	233.5	48.1	16.0	91.2	68.1	38.3	48.6	6.7	164.0	43.5	21.7
Queue Delay	0.0	0.0	0.0	0.0	0.0	0.0	0.0	0.0	0.0	0.0	0.0
Total Delay	233.5	48.1	16.0	91.2	68.1	38.3	48.6	6.7	164.0	43.5	21.7
Queue Length 50th (ft)	~409	347	45	42	391	102	482	3	~339	333	137
Queue Length 95th (ft)	#534	433	111	83	476	154	568	47	m#415	m350	m153
Internal Link Dist (ft)		387			374		435			2618	
Turn Bay Length (ft)	310		140	220		230			170		170
Base Capacity (vph)	418	1188	595	215	939	266	1316	650	245	1402	790
Starvation Cap Reductn	0	0	0	0	0	0	0	0	0	0	0
Spillback Cap Reductn	0	0	0	0	0	0	0	0	0	0	0
Storage Cap Reductn	0	0	0	0	0	0	0	0	0	0	0
Reduced v/c Ratio	1.38	0.63	0.29	0.19	0.86	0.66	0.76	0.18	1.22	0.64	0.58

Intersection Summary

~ Volume exceeds capacity, queue is theoretically infinite.

Queue shown is maximum after two cycles.





























95th percentile volume exceeds capacity, queue may be longer.

Queue shown is maximum after two cycles.

m Volume for 95th percentile queue is metered by upstream signal.

HCM 6th Signalized Intersection Summary

110: Southgate Boulevard & Rock Island Road

												
Movement	EBL	EBT	EBR	WBL	WBT	WBR	NBL	NBT	NBR	SBL	SBT	SBR
Lane Configurations	 	 			 			 			 	
Traffic Volume (veh/h)	553	720	167	38	483	291	169	961	112	288	864	441
Future Volume (veh/h)	553	720	167	38	483	291	169	961	112	288	864	441
Initial Q (Qb), veh	0	0	0	0	0	0	0	0	0	0	0	0
Ped-Bike Adj(A_pbT)	1.00		1.00	1.00		0.99	1.00		1.00	1.00		1.00
Parking Bus, Adj	1.00	1.00	1.00	1.00	1.00	1.00	1.00	1.00	1.00	1.00	1.00	1.00
Work Zone On Approach		No			No			No			No	
Adj Sat Flow, veh/h/ln	1870	1870	1870	1870	1870	1870	1870	1870	1870	1870	1870	1870
Adj Flow Rate, veh/h	576	750	174	40	503	303	176	1001	0	300	900	459
Peak Hour Factor	0.96	0.96	0.96	0.96	0.96	0.96	0.96	0.96	0.96	0.96	0.96	0.96
Percent Heavy Veh, %	2	2	2	2	2	2	2	2	2	2	2	2
Cap, veh/h	421	1230	546	52	539	324	257	1366		277	1385	617
Arrive On Green	0.12	0.35	0.35	0.03	0.25	0.25	0.10	0.51	0.00	0.10	0.52	0.52
Sat Flow, veh/h	3456	3554	1578	1781	2129	1279	1781	3554	1585	1781	3554	1583
Grp Volume(v), veh/h	576	750	174	40	419	387	176	1001	0	300	900	459
Grp Sat Flow(s),veh/h/ln	1728	1777	1578	1781	1777	1631	1781	1777	1585	1781	1777	1583
Q Serve(g_s), s	19.5	28.0	13.0	3.6	36.9	37.1	9.6	35.2	0.0	12.5	29.4	36.4
Cycle Q Clear(g_c), s	19.5	28.0	13.0	3.6	36.9	37.1	9.6	35.2	0.0	12.5	29.4	36.4
Prop In Lane	1.00		1.00	1.00		0.78	1.00		1.00	1.00		1.00
Lane Grp Cap(c), veh/h	421	1230	546	52	450	413	257	1366		277	1385	617
V/C Ratio(X)	1.37	0.61	0.32	0.77	0.93	0.94	0.68	0.73		1.08	0.65	0.74
Avail Cap(c_a), veh/h	421	1230	546	217	472	433	267	1366		277	1385	617
HCM Platoon Ratio	1.00	1.00	1.00	1.00	1.00	1.00	1.33	1.33	1.33	1.33	1.33	1.33
Upstream Filter(I)	1.00	1.00	1.00	1.00	1.00	1.00	1.00	1.00	0.00	0.21	0.21	0.21
Uniform Delay (d), s/veh	70.3	43.4	38.5	77.2	58.4	58.5	29.9	32.7	0.0	41.2	30.6	32.3
Incr Delay (d2), s/veh	180.0	0.6	0.1	8.8	24.4	26.6	5.5	3.5	0.0	51.2	0.5	1.8
Initial Q Delay(d3),s/veh	0.0	0.0	0.0	0.0	0.0	0.0	0.0	0.0	0.0	0.0	0.0	0.0
%ile BackOfQ(50%),veh/ln	19.2	12.6	5.1	1.8	19.7	18.4	4.4	15.0	0.0	9.3	12.0	13.4
Unsig. Movement Delay, s/veh												
LnGrp Delay(d),s/veh	250.3	44.0	38.6	86.0	82.8	85.1	35.3	36.2	0.0	92.3	31.1	34.0
LnGrp LOS	F	D	D	F	F	F	D	D		F	C	C
Approach Vol, veh/h		1500			846			1177			1659	
Approach Delay, s/veh		122.6			84.0			36.1			43.0	
Approach LOS		F			F			D			D	
Timer - Assigned Phs	1	2	3	4	5	6	7	8				
Phs Duration (G+Y+Rc), s	19.0	68.0	11.1	61.9	18.1	68.9	26.0	47.0				
Change Period (Y+Rc), s	6.5	6.5	6.5	6.5	6.5	6.5	6.5	6.5				
Max Green Setting (Gmax), s	12.5	59.5	19.5	42.5	12.5	59.5	19.5	42.5				
Max Q Clear Time (g_c+I1), s	14.5	37.2	5.6	30.0	11.6	38.4	21.5	39.1				
Green Ext Time (p_c), s	0.0	7.7	0.0	3.3	0.0	8.6	0.0	1.3				
Intersection Summary												
HCM 6th Ctrl Delay				71.2								
HCM 6th LOS				E								
Notes												
Unsignalized Delay for [NBR] is excluded from calculations of the approach delay and intersection delay.												

Timings

111: NW 66 Avenue & Atlantic Boulevard

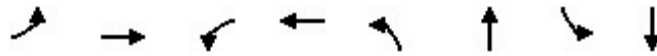

Lane Group	EBL	EBT	WBL	WBT	NBL	NBT	SBL	SBT
Lane Configurations	↶	↶↶↶	↶	↶↶↶	↶	↶	↶	↶
Traffic Volume (vph)	148	1806	17	837	66	24	126	19
Future Volume (vph)	148	1806	17	837	66	24	126	19
Turn Type	pm+pt	NA	pm+pt	NA	Perm	NA	Perm	NA
Protected Phases	1	6	5	2		4		8
Permitted Phases	6		2		4		8	
Detector Phase	1	6	5	2	4	4	8	8
Switch Phase								
Minimum Initial (s)	4.0	10.0	4.0	10.0	6.0	6.0	6.0	6.0
Minimum Split (s)	12.0	50.0	12.0	50.0	45.0	45.0	45.0	45.0
Total Split (s)	25.0	87.0	25.0	87.0	48.0	48.0	48.0	48.0
Total Split (%)	15.6%	54.4%	15.6%	54.4%	30.0%	30.0%	30.0%	30.0%
Yellow Time (s)	4.0	4.0	4.0	4.0	4.0	4.0	4.0	4.0
All-Red Time (s)	2.0	2.0	2.0	2.0	2.0	2.0	2.0	2.0
Lost Time Adjust (s)	0.0	0.0	0.0	0.0	0.0	0.0	0.0	0.0
Total Lost Time (s)	6.0	6.0	6.0	6.0	6.0	6.0	6.0	6.0
Lead/Lag	Lead	Lag	Lead	Lag				
Lead-Lag Optimize?	Yes	Yes	Yes	Yes				
Recall Mode	None	C-Max	None	C-Max	None	None	None	None
Act Effct Green (s)	125.7	120.4	117.6	113.2	21.2	21.2	21.2	21.2
Actuated g/C Ratio	0.79	0.75	0.74	0.71	0.13	0.13	0.13	0.13
v/c Ratio	0.38	0.52	0.12	0.28	0.58	0.29	0.79	0.43
Control Delay	7.0	9.9	6.6	9.3	82.0	26.9	96.0	18.3
Queue Delay	0.0	0.0	0.0	0.0	0.0	0.0	0.0	0.0
Total Delay	7.0	9.9	6.6	9.3	82.0	26.9	96.0	18.3
LOS	A	A	A	A	F	C	F	B
Approach Delay		9.7		9.3		53.9		57.6
Approach LOS		A		A		D		E

Intersection Summary

Cycle Length: 160

Actuated Cycle Length: 160

Offset: 50 (31%), Referenced to phase 2:WBTL and 6:EBTL, Start of Yellow

Natural Cycle: 110

Control Type: Actuated-Coordinated

Maximum v/c Ratio: 0.79

Intersection Signal Delay: 15.0

Intersection LOS: B

Intersection Capacity Utilization 76.3%

ICU Level of Service D

Analysis Period (min) 15

Splits and Phases: 111: NW 66 Avenue & Atlantic Boulevard

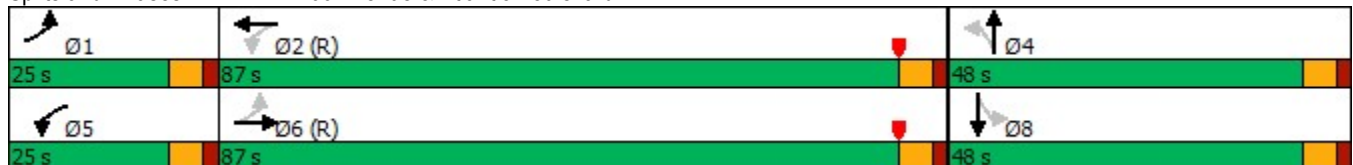

Queues

111: NW 66 Avenue & Atlantic Boulevard

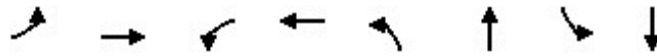

Lane Group	EBL	EBT	WBL	WBT	NBL	NBT	SBL	SBT
Lane Group Flow (vph)	161	1997	18	998	72	75	137	134
v/c Ratio	0.38	0.52	0.12	0.28	0.58	0.29	0.79	0.43
Control Delay	7.0	9.9	6.6	9.3	82.0	26.9	96.0	18.3
Queue Delay	0.0	0.0	0.0	0.0	0.0	0.0	0.0	0.0
Total Delay	7.0	9.9	6.6	9.3	82.0	26.9	96.0	18.3
Queue Length 50th (ft)	34	313	3	126	72	24	141	20
Queue Length 95th (ft)	67	431	12	190	123	73	210	82
Internal Link Dist (ft)		2560		1156		610		2153
Turn Bay Length (ft)	200		200		190		190	
Base Capacity (vph)	523	3815	310	3548	247	471	343	503
Starvation Cap Reductn	0	0	0	0	0	0	0	0
Spillback Cap Reductn	0	0	0	0	0	0	0	0
Storage Cap Reductn	0	0	0	0	0	0	0	0
Reduced v/c Ratio	0.31	0.52	0.06	0.28	0.29	0.16	0.40	0.27

Intersection Summary

HCM 6th Signalized Intersection Summary

111: NW 66 Avenue & Atlantic Boulevard

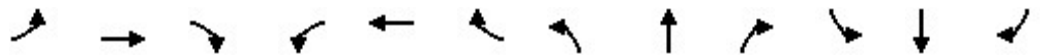

Movement	EBL	EBT	EBR	WBL	WBT	WBR	NBL	NBT	NBR	SBL	SBT	SBR
Lane Configurations	↖	↑↑↑		↖	↑↑↑		↖	↑		↖	↑	
Traffic Volume (veh/h)	148	1806	31	17	837	81	66	24	45	126	19	104
Future Volume (veh/h)	148	1806	31	17	837	81	66	24	45	126	19	104
Initial Q (Qb), veh	0	0	0	0	0	0	0	0	0	0	0	0
Ped-Bike Adj(A_pbT)	1.00		1.00	1.00		0.98	0.99		0.99	0.99		0.99
Parking Bus, Adj	1.00	1.00	1.00	1.00	1.00	1.00	1.00	1.00	1.00	1.00	1.00	1.00
Work Zone On Approach		No			No			No			No	
Adj Sat Flow, veh/h/ln	1870	1870	1870	1870	1870	1870	1870	1870	1870	1870	1870	1870
Adj Flow Rate, veh/h	161	1963	34	18	910	88	72	26	49	137	21	113
Peak Hour Factor	0.92	0.92	0.92	0.92	0.92	0.92	0.92	0.92	0.92	0.92	0.92	0.92
Percent Heavy Veh, %	2	2	2	2	2	2	2	2	2	2	2	2
Cap, veh/h	458	3658	63	184	3218	310	161	96	180	214	42	225
Arrive On Green	0.04	0.71	0.71	0.01	0.68	0.68	0.22	0.22	0.22	0.22	0.22	0.22
Sat Flow, veh/h	1781	5169	89	1781	4725	455	1247	576	1085	1313	252	1357
Grp Volume(v), veh/h	161	1292	705	18	655	343	72	0	75	137	0	134
Grp Sat Flow(s),veh/h/ln	1781	1702	1854	1781	1702	1777	1247	0	1661	1313	0	1609
Q Serve(g_s), s	4.4	28.6	28.7	0.5	12.2	12.2	8.8	0.0	6.0	16.1	0.0	11.7
Cycle Q Clear(g_c), s	4.4	28.6	28.7	0.5	12.2	12.2	20.5	0.0	6.0	22.1	0.0	11.7
Prop In Lane	1.00		0.05	1.00		0.26	1.00		0.65	1.00		0.84
Lane Grp Cap(c), veh/h	458	2409	1312	184	2318	1210	161	0	276	214	0	267
V/C Ratio(X)	0.35	0.54	0.54	0.10	0.28	0.28	0.45	0.00	0.27	0.64	0.00	0.50
Avail Cap(c_a), veh/h	598	2409	1312	371	2318	1210	281	0	436	341	0	422
HCM Platoon Ratio	1.00	1.00	1.00	1.00	1.00	1.00	1.33	1.33	1.33	1.33	1.33	1.33
Upstream Filter(l)	1.00	1.00	1.00	1.00	1.00	1.00	1.00	0.00	1.00	1.00	0.00	1.00
Uniform Delay (d), s/veh	7.4	11.0	11.0	9.6	10.1	10.1	65.5	0.0	54.3	63.5	0.0	56.5
Incr Delay (d2), s/veh	0.2	0.9	1.6	0.1	0.3	0.6	0.7	0.0	0.2	1.2	0.0	0.5
Initial Q Delay(d3),s/veh	0.0	0.0	0.0	0.0	0.0	0.0	0.0	0.0	0.0	0.0	0.0	0.0
%ile BackOfQ(50%),veh/ln	1.7	10.8	12.1	0.2	4.7	5.0	2.8	0.0	2.5	5.3	0.0	4.7
Unsig. Movement Delay, s/veh												
LnGrp Delay(d),s/veh	7.6	11.9	12.6	9.6	10.4	10.7	66.2	0.0	54.5	64.7	0.0	57.1
LnGrp LOS	A	B	B	A	B	B	E	A	D	E	A	E
Approach Vol, veh/h		2158			1016			147				271
Approach Delay, s/veh		11.8			10.5			60.3				60.9
Approach LOS		B			B			E				E
Timer - Assigned Phs	1	2		4	5	6		8				
Phs Duration (G+Y+Rc), s	12.5	115.0		32.6	8.2	119.2		32.6				
Change Period (Y+Rc), s	6.0	6.0		6.0	6.0	6.0		6.0				
Max Green Setting (Gmax), s	19.0	81.0		42.0	19.0	81.0		42.0				
Max Q Clear Time (g_c+I1), s	6.4	14.2		22.5	2.5	30.7		24.1				
Green Ext Time (p_c), s	0.1	8.7		0.3	0.0	25.4		0.7				

Intersection Summary

HCM 6th Ctrl Delay	17.1
HCM 6th LOS	B

Notes

User approved pedestrian interval to be less than phase max green.

HCM 6th AWSC
 112: NW 66 Avenue & Margate Boulevard

Intersection	
Intersection Delay, s/veh	16.4
Intersection LOS	C

Movement	EBL	EBT	EBR	WBL	WBT	WBR	NBL	NBT	NBR	SBL	SBT	SBR
Lane Configurations												
Traffic Vol, veh/h	93	500	60	24	135	18	37	56	64	44	73	64
Future Vol, veh/h	93	500	60	24	135	18	37	56	64	44	73	64
Peak Hour Factor	0.87	0.87	0.87	0.87	0.87	0.87	0.87	0.87	0.87	0.87	0.87	0.87
Heavy Vehicles, %	2	2	2	2	2	2	2	2	2	2	2	2
Mvmt Flow	107	575	69	28	155	21	43	64	74	51	84	74
Number of Lanes	1	2	0	0	2	0	0	1	0	0	1	0

Approach	EB	WB	NB	SB
Opposing Approach	WB	EB	SB	NB
Opposing Lanes	2	3	1	1
Conflicting Approach Left	SB	NB	EB	WB
Conflicting Lanes Left	1	1	3	2
Conflicting Approach Right	NB	SB	WB	EB
Conflicting Lanes Right	1	1	2	3
HCM Control Delay	18	13	14.4	15.4
HCM LOS	C	B	B	C

Lane	NBLn1	EBLn1	EBLn2	EBLn3	WBLn1	WBLn2	SBLn1
Vol Left, %	24%	100%	0%	0%	26%	0%	24%
Vol Thru, %	36%	0%	100%	74%	74%	79%	40%
Vol Right, %	41%	0%	0%	26%	0%	21%	35%
Sign Control	Stop	Stop	Stop	Stop	Stop	Stop	Stop
Traffic Vol by Lane	157	93	333	227	92	86	181
LT Vol	37	93	0	0	24	0	44
Through Vol	56	0	333	167	68	68	73
RT Vol	64	0	0	60	0	18	64
Lane Flow Rate	180	107	383	261	105	98	208
Geometry Grp	7	7	7	7	8	8	7
Degree of Util (X)	0.37	0.208	0.69	0.456	0.235	0.212	0.425
Departure Headway (Hd)	7.383	6.997	6.486	6.297	8.058	7.771	7.35
Convergence, Y/N	Yes	Yes	Yes	Yes	Yes	Yes	Yes
Cap	487	516	559	576	445	462	491
Service Time	5.129	4.697	4.186	3.997	5.814	5.526	5.094
HCM Lane V/C Ratio	0.37	0.207	0.685	0.453	0.236	0.212	0.424
HCM Control Delay	14.4	11.5	22.4	14.2	13.3	12.6	15.4
HCM Lane LOS	B	B	C	B	B	B	C
HCM 95th-tile Q	1.7	0.8	5.3	2.4	0.9	0.8	2.1

HCM 6th TWSC
201: Driveway & Margate Blvd

Intersection						
Int Delay, s/veh	1.2					
Movement	EBT	EBR	WBL	WBT	NBL	NBR
Lane Configurations	↑↑		↖	↑↑		↗
Traffic Vol, veh/h	250	0	15	128	0	49
Future Vol, veh/h	250	0	15	128	0	49
Conflicting Peds, #/hr	0	0	0	0	0	0
Sign Control	Free	Free	Free	Free	Stop	Stop
RT Channelized	-	None	-	None	-	None
Storage Length	-	-	75	-	-	0
Veh in Median Storage, #	0	-	-	0	1	-
Grade, %	0	-	-	0	0	-
Peak Hour Factor	92	92	92	92	92	92
Heavy Vehicles, %	2	2	2	2	2	2
Mvmt Flow	272	0	16	139	0	53

Major/Minor	Major1	Major2	Minor1	Minor2	Minor3
Conflicting Flow All	0	0	272	0	136
Stage 1	-	-	-	-	-
Stage 2	-	-	-	-	-
Critical Hdwy	-	-	4.14	-	4
Critical Hdwy Stg 1	-	-	-	-	-
Critical Hdwy Stg 2	-	-	-	-	-
Follow-up Hdwy	-	-	2.22	-	3.32
Pot Cap-1 Maneuver	-	-	1288	-	992
Stage 1	-	-	-	-	0
Stage 2	-	-	-	-	0
Platoon blocked, %	-	-	-	-	-
Mov Cap-1 Maneuver	-	-	1288	-	992
Mov Cap-2 Maneuver	-	-	-	-	-
Stage 1	-	-	-	-	-
Stage 2	-	-	-	-	-

Approach	EB	WB	NB
HCM Control Delay, s	0	0.8	8.8
HCM LOS			A

Minor Lane/Major Mvmt	NBLn1	EBT	EBR	WBL	WBT
Capacity (veh/h)	992	-	-	1288	-
HCM Lane V/C Ratio	0.054	-	-	0.013	-
HCM Control Delay (s)	8.8	-	-	7.8	-
HCM Lane LOS	A	-	-	A	-
HCM 95th %tile Q(veh)	0.2	-	-	0	-

Timings

101: Rock Island Road & Royal Palm Boulevard

Lane Group	EBL	EBT	WBL	WBT	NBL	NBT	NBR	SBL	SBT	SBR
Lane Configurations										
Traffic Volume (vph)	129	531	269	916	341	605	242	189	711	170
Future Volume (vph)	129	531	269	916	341	605	242	189	711	170
Turn Type	Prot	NA	Prot	NA	pm+pt	NA	Perm	pm+pt	NA	Perm
Protected Phases	1	6	5	2	7	4		3	8	
Permitted Phases					4		4	8		8
Detector Phase	1	6	5	2	7	4	4	3	8	8
Switch Phase										
Minimum Initial (s)	5.0	10.0	5.0	10.0	4.0	6.0	6.0	4.0	6.0	6.0
Minimum Split (s)	11.5	43.5	11.5	43.5	10.5	43.5	43.5	10.5	39.0	39.0
Total Split (s)	26.0	64.0	26.0	64.0	31.0	45.0	45.0	25.0	39.0	39.0
Total Split (%)	16.3%	40.0%	16.3%	40.0%	19.4%	28.1%	28.1%	15.6%	24.4%	24.4%
Yellow Time (s)	4.5	4.5	4.5	4.5	4.5	4.5	4.5	4.5	4.5	4.5
All-Red Time (s)	2.0	2.0	2.0	2.0	2.0	2.0	2.0	2.0	2.0	2.0
Lost Time Adjust (s)	0.0	0.0	0.0	0.0	0.0	0.0	0.0	0.0	0.0	0.0
Total Lost Time (s)	6.5	6.5	6.5	6.5	6.5	6.5	6.5	6.5	6.5	6.5
Lead/Lag	Lead	Lag	Lead	Lag	Lead	Lag	Lag	Lead	Lag	Lag
Lead-Lag Optimize?	Yes	Yes	Yes	Yes	Yes	Yes	Yes	Yes	Yes	Yes
Recall Mode	None	C-Max	None	C-Max	None	None	None	None	None	None
Act Effct Green (s)	15.4	57.5	19.5	61.6	63.3	41.6	41.6	47.9	32.5	32.5
Actuated g/C Ratio	0.10	0.36	0.12	0.38	0.40	0.26	0.26	0.30	0.20	0.20
v/c Ratio	0.79	0.62	1.30	0.89	1.12	0.69	0.47	0.72	1.03	0.43
Control Delay	99.9	42.5	217.4	54.5	140.5	43.5	11.7	49.5	102.9	24.4
Queue Delay	0.0	0.0	0.0	0.0	0.0	0.0	0.0	0.0	0.0	0.0
Total Delay	99.9	42.5	217.4	54.5	140.5	43.5	11.7	49.5	102.9	24.4
LOS	F	D	F	D	F	D	B	D	F	C
Approach Delay		51.0		85.7		64.9			81.0	
Approach LOS		D		F		E			F	

Intersection Summary

Cycle Length: 160	
Actuated Cycle Length: 160	
Offset: 104 (65%), Referenced to phase 2:WBT and 6:EBT, Start of Yellow	
Natural Cycle: 140	
Control Type: Actuated-Coordinated	
Maximum v/c Ratio: 1.30	
Intersection Signal Delay: 72.5	Intersection LOS: E
Intersection Capacity Utilization 99.6%	ICU Level of Service F
Analysis Period (min) 15	

Splits and Phases: 101: Rock Island Road & Royal Palm Boulevard

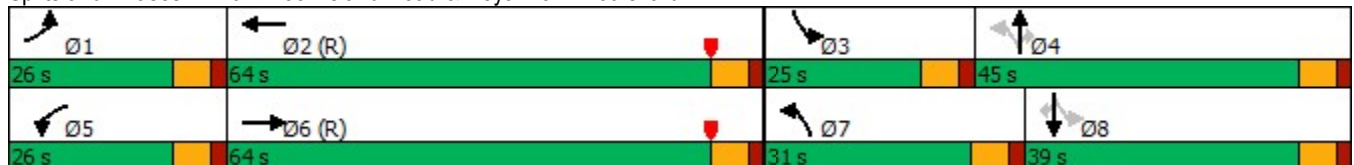

Queues

101: Rock Island Road & Royal Palm Boulevard



Lane Group	EBL	EBT	WBL	WBT	NBL	NBT	NBR	SBL	SBT	SBR
Lane Group Flow (vph)	134	772	280	1181	355	630	252	197	741	177
v/c Ratio	0.79	0.62	1.30	0.89	1.12	0.69	0.47	0.72	1.03	0.43
Control Delay	99.9	42.5	217.4	54.5	140.5	43.5	11.7	49.5	102.9	24.4
Queue Delay	0.0	0.0	0.0	0.0	0.0	0.0	0.0	0.0	0.0	0.0
Total Delay	99.9	42.5	217.4	54.5	140.5	43.5	11.7	49.5	102.9	24.4
Queue Length 50th (ft)	139	332	~373	600	~360	303	40	139	~435	57
Queue Length 95th (ft)	213	405	#568	#768	#580	345	75	206	#568	136
Internal Link Dist (ft)		625		856		3088			735	
Turn Bay Length (ft)	300		200		200		160	140		170
Base Capacity (vph)	215	1243	215	1334	317	919	533	307	718	410
Starvation Cap Reductn	0	0	0	0	0	0	0	0	0	0
Spillback Cap Reductn	0	0	0	0	0	0	0	0	0	0
Storage Cap Reductn	0	0	0	0	0	0	0	0	0	0
Reduced v/c Ratio	0.62	0.62	1.30	0.89	1.12	0.69	0.47	0.64	1.03	0.43

Intersection Summary

~ Volume exceeds capacity, queue is theoretically infinite.

Queue shown is maximum after two cycles.

95th percentile volume exceeds capacity, queue may be longer.

Queue shown is maximum after two cycles.

HCM 6th Signalized Intersection Summary

101: Rock Island Road & Royal Palm Boulevard

Movement	EBL	EBT	EBR	WBL	WBT	WBR	NBL	NBT	NBR	SBL	SBT	SBR
Lane Configurations												
Traffic Volume (veh/h)	129	531	210	269	916	218	341	605	242	189	711	170
Future Volume (veh/h)	129	531	210	269	916	218	341	605	242	189	711	170
Initial Q (Qb), veh	0	0	0	0	0	0	0	0	0	0	0	0
Ped-Bike Adj(A_pbT)	1.00		1.00	1.00		1.00	1.00		1.00	1.00		1.00
Parking Bus, Adj	1.00	1.00	1.00	1.00	1.00	1.00	1.00	1.00	1.00	1.00	1.00	1.00
Work Zone On Approach		No			No			No			No	
Adj Sat Flow, veh/h/ln	1870	1870	1870	1870	1870	1870	1870	1870	1870	1870	1870	1870
Adj Flow Rate, veh/h	134	553	219	280	954	227	355	630	252	197	741	177
Peak Hour Factor	0.96	0.96	0.96	0.96	0.96	0.96	0.96	0.96	0.96	0.96	0.96	0.96
Percent Heavy Veh, %	2	2	2	2	2	2	2	2	2	2	2	2
Cap, veh/h	154	894	353	217	1124	267	318	912	407	275	722	322
Arrive On Green	0.12	0.48	0.48	0.16	0.52	0.52	0.05	0.08	0.08	0.10	0.20	0.20
Sat Flow, veh/h	1781	2488	982	1781	2849	677	1781	3554	1585	1781	3554	1585
Grp Volume(v), veh/h	134	394	378	280	594	587	355	630	252	197	741	177
Grp Sat Flow(s),veh/h/ln	1781	1777	1694	1781	1777	1749	1781	1777	1585	1781	1777	1585
Q Serve(g_s), s	11.8	26.3	26.5	19.5	45.8	46.0	24.5	27.6	24.6	13.9	32.5	16.0
Cycle Q Clear(g_c), s	11.8	26.3	26.5	19.5	45.8	46.0	24.5	27.6	24.6	13.9	32.5	16.0
Prop In Lane	1.00		0.58	1.00		0.39	1.00		1.00	1.00		1.00
Lane Grp Cap(c), veh/h	154	639	609	217	701	690	318	912	407	275	722	322
V/C Ratio(X)	0.87	0.62	0.62	1.29	0.85	0.85	1.12	0.69	0.62	0.72	1.03	0.55
Avail Cap(c_a), veh/h	217	639	609	217	701	690	318	912	407	304	722	322
HCM Platoon Ratio	1.33	1.33	1.33	1.33	1.33	1.33	0.33	0.33	0.33	1.00	1.00	1.00
Upstream Filter(I)	1.00	1.00	1.00	1.00	1.00	1.00	0.93	0.93	0.93	1.00	1.00	1.00
Uniform Delay (d), s/veh	69.9	33.6	33.7	67.0	33.9	33.9	59.9	67.0	65.7	45.4	63.8	57.2
Incr Delay (d2), s/veh	17.6	4.4	4.7	160.4	12.1	12.5	84.2	1.7	2.0	5.5	40.4	1.2
Initial Q Delay(d3),s/veh	0.0	0.0	0.0	0.0	0.0	0.0	0.0	0.0	0.0	0.0	0.0	0.0
%ile BackOfQ(50%),veh/ln	6.0	11.6	11.2	18.3	20.8	20.7	17.7	13.5	10.8	6.6	18.8	6.6
Unsig. Movement Delay, s/veh												
LnGrp Delay(d),s/veh	87.5	38.1	38.4	227.4	46.0	46.4	144.1	68.8	67.6	50.9	104.2	58.4
LnGrp LOS	F	D	D	F	D	D	F	E	E	D	F	E
Approach Vol, veh/h		906			1461			1237			1115	
Approach Delay, s/veh		45.5			80.9			90.2			87.5	
Approach LOS		D			F			F			F	
Timer - Assigned Phs	1	2	3	4	5	6	7	8				
Phs Duration (G+Y+Rc), s	20.3	69.7	22.4	47.6	26.0	64.0	31.0	39.0				
Change Period (Y+Rc), s	6.5	6.5	6.5	6.5	6.5	6.5	6.5	6.5				
Max Green Setting (Gmax), s	19.5	57.5	18.5	38.5	19.5	57.5	24.5	32.5				
Max Q Clear Time (g_c+I1), s	13.8	48.0	15.9	29.6	21.5	28.5	26.5	34.5				
Green Ext Time (p_c), s	0.0	5.3	0.0	2.4	0.0	5.6	0.0	0.0				
Intersection Summary												
HCM 6th Ctrl Delay				78.1								
HCM 6th LOS				E								
Notes												
User approved pedestrian interval to be less than phase max green.												

HCM 6th TWSC
 102: NW 76 Avenue & Margate Boulevard

Intersection						
Int Delay, s/veh	5.5					
Movement	EBT	EBR	WBL	WBT	NBL	NBR
Lane Configurations	↑↑		↖	↑↑	↘	
Traffic Vol, veh/h	59	81	112	105	139	51
Future Vol, veh/h	59	81	112	105	139	51
Conflicting Peds, #/hr	0	0	0	0	1	2
Sign Control	Free	Free	Free	Free	Stop	Stop
RT Channelized	-	None	-	None	-	None
Storage Length	-	-	100	-	0	-
Veh in Median Storage, #	0	-	-	0	1	-
Grade, %	0	-	-	0	0	-
Peak Hour Factor	87	87	87	87	87	87
Heavy Vehicles, %	2	2	2	2	2	2
Mvmt Flow	68	93	129	121	160	59

Major/Minor	Major1	Major2	Minor1		
Conflicting Flow All	0	0	161	0	435
Stage 1	-	-	-	-	115
Stage 2	-	-	-	-	320
Critical Hdwy	-	-	4.14	-	5
Critical Hdwy Stg 1	-	-	-	-	5
Critical Hdwy Stg 2	-	-	-	-	5
Follow-up Hdwy	-	-	2.22	-	3
Pot Cap-1 Maneuver	-	-	1416	-	782
Stage 1	-	-	-	-	1073
Stage 2	-	-	-	-	877
Platoon blocked, %	-	-	-	-	-
Mov Cap-1 Maneuver	-	-	1416	-	710
Mov Cap-2 Maneuver	-	-	-	-	712
Stage 1	-	-	-	-	1073
Stage 2	-	-	-	-	796

Approach	EB	WB	NB
HCM Control Delay, s	0	4	11.3
HCM LOS			B

Minor Lane/Major Mvmt	NBLn1	EBT	EBR	WBL	WBT
Capacity (veh/h)	789	-	-	1416	-
HCM Lane V/C Ratio	0.277	-	-	0.091	-
HCM Control Delay (s)	11.3	-	-	7.8	-
HCM Lane LOS	B	-	-	A	-
HCM 95th %tile Q(veh)	1.1	-	-	0.3	-

Timings

103: Rock Island Road & Margate Boulevard

Lane Group	EBL	EBT	WBL	WBT	NBL	NBT	NBR	SBL	SBT	SBR
Lane Configurations										
Traffic Volume (vph)	56	37	158	136	30	849	157	105	845	86
Future Volume (vph)	56	37	158	136	30	849	157	105	845	86
Turn Type	pm+pt	NA	pm+pt	NA	pm+pt	NA	Perm	pm+pt	NA	Perm
Protected Phases	7	4	3	8	5	2		1	6	
Permitted Phases	4		8		2		2	6		6
Detector Phase	7	4	3	8	5	2	2	1	6	6
Switch Phase										
Minimum Initial (s)	4.0	6.0	4.0	6.0	4.0	12.0	12.0	4.0	12.0	12.0
Minimum Split (s)	10.0	37.0	10.0	37.0	10.5	37.5	37.5	10.5	37.5	37.5
Total Split (s)	18.0	40.0	18.0	40.0	26.0	76.0	76.0	26.0	76.0	76.0
Total Split (%)	11.3%	25.0%	11.3%	25.0%	16.3%	47.5%	47.5%	16.3%	47.5%	47.5%
Yellow Time (s)	4.0	4.0	4.0	4.0	4.5	4.5	4.5	4.5	4.5	4.5
All-Red Time (s)	2.0	2.0	2.0	2.0	2.0	2.0	2.0	2.0	2.0	2.0
Lost Time Adjust (s)	0.0	0.0	0.0	0.0	0.0	0.0	0.0	0.0	0.0	0.0
Total Lost Time (s)	6.0	6.0	6.0	6.0	6.5	6.5	6.5	6.5	6.5	6.5
Lead/Lag	Lead	Lag	Lead	Lag	Lead	Lag	Lag	Lead	Lag	Lag
Lead-Lag Optimize?	Yes	Yes	Yes	Yes	Yes	Yes	Yes	Yes	Yes	Yes
Recall Mode	None	None	None	None	None	C-Max	C-Max	None	C-Max	C-Max
Act Effct Green (s)	17.6	10.1	22.9	13.3	113.3	108.5	108.5	118.5	112.6	112.6
Actuated g/C Ratio	0.11	0.06	0.14	0.08	0.71	0.68	0.68	0.74	0.70	0.70
v/c Ratio	0.42	0.27	0.88	0.73	0.08	0.38	0.15	0.27	0.37	0.08
Control Delay	64.9	48.9	102.1	45.6	6.0	10.2	4.6	4.9	7.5	0.3
Queue Delay	0.0	0.0	0.0	0.0	0.0	0.0	0.0	0.0	0.0	0.0
Total Delay	64.9	48.9	102.1	45.6	6.0	10.2	4.6	4.9	7.5	0.3
LOS	E	D	F	D	A	B	A	A	A	A
Approach Delay		56.8		66.0		9.2			6.6	
Approach LOS		E		E		A			A	

Intersection Summary

Cycle Length: 160	
Actuated Cycle Length: 160	
Offset: 104 (65%), Referenced to phase 2:NBTL and 6:SBTL, Start of Yellow	
Natural Cycle: 95	
Control Type: Actuated-Coordinated	
Maximum v/c Ratio: 0.88	
Intersection Signal Delay: 19.7	Intersection LOS: B
Intersection Capacity Utilization 63.9%	ICU Level of Service B
Analysis Period (min) 15	

Splits and Phases: 103: Rock Island Road & Margate Boulevard

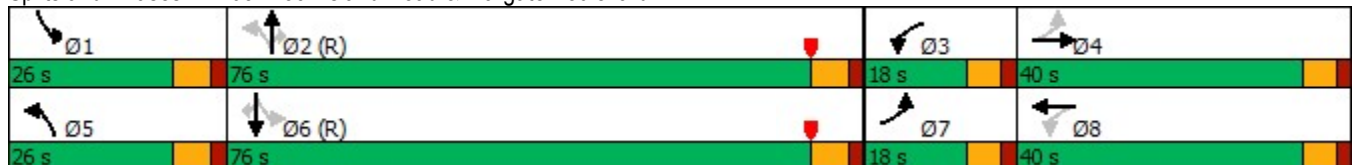

Queues

103: Rock Island Road & Margate Boulevard



Lane Group	EBL	EBT	WBL	WBT	NBL	NBT	NBR	SBL	SBT	SBR
Lane Group Flow (vph)	60	62	170	301	32	913	169	113	909	92
v/c Ratio	0.42	0.27	0.88	0.73	0.08	0.38	0.15	0.27	0.37	0.08
Control Delay	64.9	48.9	102.1	45.6	6.0	10.2	4.6	4.9	7.5	0.3
Queue Delay	0.0	0.0	0.0	0.0	0.0	0.0	0.0	0.0	0.0	0.0
Total Delay	64.9	48.9	102.1	45.6	6.0	10.2	4.6	4.9	7.5	0.3
Queue Length 50th (ft)	55	21	166	81	8	147	16	19	143	0
Queue Length 95th (ft)	95	45	#252	131	m13	m178	m31	m31	m199	m1
Internal Link Dist (ft)		2155		508		3616			3088	
Turn Bay Length (ft)	320		110		180		180	190		160
Base Capacity (vph)	179	729	193	814	558	2399	1110	534	2490	1145
Starvation Cap Reductn	0	0	0	0	0	0	0	0	0	0
Spillback Cap Reductn	0	0	0	0	0	0	0	0	0	0
Storage Cap Reductn	0	0	0	0	0	0	0	0	0	0
Reduced v/c Ratio	0.34	0.09	0.88	0.37	0.06	0.38	0.15	0.21	0.37	0.08

Intersection Summary

95th percentile volume exceeds capacity, queue may be longer.

Queue shown is maximum after two cycles.

m Volume for 95th percentile queue is metered by upstream signal.

HCM 6th Signalized Intersection Summary

103: Rock Island Road & Margate Boulevard

Movement	EBL	EBT	EBR	WBL	WBT	WBR	NBL	NBT	NBR	SBL	SBT	SBR
Lane Configurations												
Traffic Volume (veh/h)	56	37	20	158	136	144	30	849	157	105	845	86
Future Volume (veh/h)	56	37	20	158	136	144	30	849	157	105	845	86
Initial Q (Qb), veh	0	0	0	0	0	0	0	0	0	0	0	0
Ped-Bike Adj(A_pbT)	1.00		1.00	1.00		1.00	1.00		1.00	1.00		1.00
Parking Bus, Adj	1.00	1.00	1.00	1.00	1.00	1.00	1.00	1.00	1.00	1.00	1.00	1.00
Work Zone On Approach		No			No			No			No	
Adj Sat Flow, veh/h/ln	1870	1870	1870	1870	1870	1870	1870	1870	1870	1870	1870	1870
Adj Flow Rate, veh/h	60	40	22	170	146	155	32	913	169	113	909	92
Peak Hour Factor	0.93	0.93	0.93	0.93	0.93	0.93	0.93	0.93	0.93	0.93	0.93	0.93
Percent Heavy Veh, %	2	2	2	2	2	2	2	2	2	2	2	2
Cap, veh/h	137	183	93	262	204	182	432	2326	1037	420	2379	1061
Arrive On Green	0.04	0.08	0.08	0.08	0.12	0.12	0.03	0.87	0.85	0.05	0.89	0.89
Sat Flow, veh/h	1781	2280	1159	1781	1777	1585	1781	3554	1585	1781	3554	1585
Grp Volume(v), veh/h	60	30	32	170	146	155	32	913	169	113	909	92
Grp Sat Flow(s),veh/h/ln	1781	1777	1662	1781	1777	1585	1781	1777	1585	1781	1777	1585
Q Serve(g_s), s	4.9	2.6	2.8	12.0	12.7	15.3	1.0	8.1	3.0	3.4	6.8	1.1
Cycle Q Clear(g_c), s	4.9	2.6	2.8	12.0	12.7	15.3	1.0	8.1	3.0	3.4	6.8	1.1
Prop In Lane	1.00		0.70	1.00		1.00	1.00		1.00	1.00		1.00
Lane Grp Cap(c), veh/h	137	143	133	262	204	182	432	2326	1037	420	2379	1061
V/C Ratio(X)	0.44	0.21	0.24	0.65	0.71	0.85	0.07	0.39	0.16	0.27	0.38	0.09
Avail Cap(c_a), veh/h	199	378	353	262	378	337	615	2326	1037	577	2379	1061
HCM Platoon Ratio	1.00	1.00	1.00	1.00	1.00	1.00	1.33	1.33	1.30	1.33	1.33	1.33
Upstream Filter(l)	1.00	1.00	1.00	1.00	1.00	1.00	0.70	0.70	0.70	0.30	0.30	0.30
Uniform Delay (d), s/veh	64.4	68.8	69.0	62.4	68.3	69.4	8.7	4.1	4.3	8.5	3.3	3.0
Incr Delay (d2), s/veh	0.8	0.3	0.3	4.3	1.7	4.2	0.0	0.3	0.2	0.0	0.1	0.0
Initial Q Delay(d3),s/veh	0.0	0.0	0.0	0.0	0.0	0.0	0.0	0.0	0.0	0.0	0.0	0.0
%ile BackOfQ(50%),veh/ln	2.3	1.2	1.2	1.1	5.9	6.5	0.4	2.5	1.0	1.3	2.0	0.4
Unsig. Movement Delay, s/veh												
LnGrp Delay(d),s/veh	65.2	69.1	69.3	66.7	70.0	73.7	8.7	4.5	4.6	8.5	3.4	3.0
LnGrp LOS	E	E	E	E	E	E	A	A	A	A	A	A
Approach Vol, veh/h		122			471			1114			1114	
Approach Delay, s/veh		67.2			70.0			4.6			3.9	
Approach LOS		E			E			A			A	
Timer - Assigned Phs	1	2	3	4	5	6	7	8				
Phs Duration (G+Y+Rc), s	11.9	111.2	18.0	18.8	9.5	113.6	12.4	24.4				
Change Period (Y+Rc), s	6.5	6.5	6.0	6.0	6.5	6.5	6.0	6.0				
Max Green Setting (Gmax), s	19.5	69.5	12.0	34.0	19.5	69.5	12.0	34.0				
Max Q Clear Time (g_c+I1), s	5.4	10.1	14.0	4.8	3.0	8.8	6.9	17.3				
Green Ext Time (p_c), s	0.1	9.2	0.0	0.2	0.0	8.7	0.0	1.1				
Intersection Summary												
HCM 6th Ctrl Delay			18.0									
HCM 6th LOS			B									

Timings

104: SR 7 & Margate Boulevard



Lane Group	EBL	EBR	NBL	NBT	SBL	SBT	Ø3
Lane Configurations	↖↗	↗	↖	↑↑↑	↖	↑↑↑	
Traffic Volume (vph)	194	70	99	1618	12	2036	
Future Volume (vph)	194	70	99	1618	12	2036	
Turn Type	Prot	Perm	Prot	NA	Prot	NA	
Protected Phases	4		5	2	1	6	3
Permitted Phases		4					
Detector Phase	4	4	5	2	1	6	
Switch Phase							
Minimum Initial (s)	7.0	7.0	4.0	12.0	4.0	12.0	5.0
Minimum Split (s)	44.5	44.5	11.5	43.0	10.0	44.5	19.0
Total Split (s)	45.0	45.0	22.0	74.0	22.0	74.0	19.0
Total Split (%)	28.1%	28.1%	13.8%	46.3%	13.8%	46.3%	12%
Yellow Time (s)	4.0	4.0	4.0	4.0	4.0	4.0	4.0
All-Red Time (s)	2.5	2.5	2.0	2.0	2.0	2.0	2.5
Lost Time Adjust (s)	0.0	0.0	0.0	0.0	0.0	0.0	
Total Lost Time (s)	6.5	6.5	6.0	6.0	6.0	6.0	
Lead/Lag	Lag	Lag	Lead	Lag	Lead	Lag	Lead
Lead-Lag Optimize?	Yes	Yes	Yes	Yes	Yes	Yes	Yes
Recall Mode	None	None	None	C-Max	None	C-Max	None
Act Effct Green (s)	13.8	13.8	13.1	128.8	5.2	114.7	
Actuated g/C Ratio	0.09	0.09	0.08	0.80	0.03	0.72	
v/c Ratio	0.68	0.31	0.71	0.41	0.21	0.62	
Control Delay	82.4	6.7	67.8	5.1	83.2	13.3	
Queue Delay	0.0	0.0	0.0	0.0	0.0	0.0	
Total Delay	82.4	6.7	67.8	5.1	83.2	13.3	
LOS	F	A	E	A	F	B	
Approach Delay				8.7		13.7	
Approach LOS				A		B	

Intersection Summary

Cycle Length: 160
 Actuated Cycle Length: 160
 Offset: 0 (0%), Referenced to phase 2:NBT and 6:SBT, Start of Yellow
 Natural Cycle: 150
 Control Type: Actuated-Coordinated
 Maximum v/c Ratio: 0.71
 Intersection Signal Delay: 14.7
 Intersection Capacity Utilization 67.5%
 Analysis Period (min) 15
 Intersection LOS: B
 ICU Level of Service C

Splits and Phases: 104: SR 7 & Margate Boulevard



Queues

104: SR 7 & Margate Boulevard































Lane Group	EBL	EBR	NBL	NBT	SBL	SBT
Lane Group Flow (vph)	200	72	102	1668	12	2254
v/c Ratio	0.68	0.31	0.71	0.41	0.21	0.62
Control Delay	82.4	6.7	67.8	5.1	83.2	13.3
Queue Delay	0.0	0.0	0.0	0.0	0.0	0.0
Total Delay	82.4	6.7	67.8	5.1	83.2	13.3
Queue Length 50th (ft)	106	0	112	147	13	407
Queue Length 95th (ft)	147	17	m137	m189	36	550
Internal Link Dist (ft)				2153		276
Turn Bay Length (ft)	120	120	250		200	
Base Capacity (vph)	826	455	182	4093	177	3609
Starvation Cap Reductn	0	0	0	0	0	0
Spillback Cap Reductn	0	0	0	0	0	0
Storage Cap Reductn	0	0	0	0	0	0
Reduced v/c Ratio	0.24	0.16	0.56	0.41	0.07	0.62

Intersection Summary

m Volume for 95th percentile queue is metered by upstream signal.

HCM Signalized Intersection Capacity Analysis

104: SR 7 & Margate Boulevard

												
Movement	EBL	EBT	EBR	WBL	WBT	WBR	NBL	NBT	NBR	SBL	SBT	SBR
Lane Configurations	 				 		 	  		 	  	
Traffic Volume (vph)	194	0	70	0	0	0	99	1618	0	12	2036	150
Future Volume (vph)	194	0	70	0	0	0	99	1618	0	12	2036	150
Ideal Flow (vphpl)	1900	1900	1900	1900	1900	1900	1900	1900	1900	1900	1900	1900
Total Lost time (s)	6.5		6.5				6.0	6.0		6.0	6.0	
Lane Util. Factor	0.97		1.00				1.00	0.91		1.00	0.91	
Frbp, ped/bikes	1.00		0.99				1.00	1.00		1.00	1.00	
Flpb, ped/bikes	1.00		1.00				1.00	1.00		1.00	1.00	
Frt	1.00		0.85				1.00	1.00		1.00	0.99	
Flt Protected	0.95		1.00				0.95	1.00		0.95	1.00	
Satd. Flow (prot)	3433		1560				1770	5085		1770	5033	
Flt Permitted	0.95		1.00				0.95	1.00		0.95	1.00	
Satd. Flow (perm)	3433		1560				1770	5085		1770	5033	
Peak-hour factor, PHF	0.97	0.97	0.97	0.97	0.97	0.97	0.97	0.97	0.97	0.97	0.97	0.97
Adj. Flow (vph)	200	0	72	0	0	0	102	1668	0	12	2099	155
RTOR Reduction (vph)	0	0	66	0	0	0	0	0	0	0	3	0
Lane Group Flow (vph)	200	0	6	0	0	0	102	1668	0	12	2251	0
Confl. Peds. (#/hr)			2	2								
Turn Type	Prot		Perm				Prot	NA	Perm	Prot	NA	
Protected Phases	4				3		5	2		1	6	
Permitted Phases			4	3					2			
Actuated Green, G (s)	13.8		13.8				13.1	125.2		2.5	114.6	
Effective Green, g (s)	13.8		13.8				13.1	125.2		2.5	114.6	
Actuated g/C Ratio	0.09		0.09				0.08	0.78		0.02	0.72	
Clearance Time (s)	6.5		6.5				6.0	6.0		6.0	6.0	
Vehicle Extension (s)	2.0		2.0				1.5	3.0		1.5	3.0	
Lane Grp Cap (vph)	296		134				144	3979		27	3604	
v/s Ratio Prot	c0.06						c0.06	0.33		0.01	c0.45	
v/s Ratio Perm			0.00									
v/c Ratio	0.68		0.05				0.71	0.42		0.44	0.62	
Uniform Delay, d1	70.9		67.1				71.6	5.6		78.1	11.7	
Progression Factor	1.00		1.00				0.74	0.94		1.00	1.00	
Incremental Delay, d2	4.7		0.1				7.1	0.2		4.2	0.8	
Delay (s)	75.7		67.1				60.4	5.5		82.3	12.5	
Level of Service	E		E				E	A		F	B	
Approach Delay (s)		73.4			0.0			8.6			12.9	
Approach LOS		E			A			A			B	
Intersection Summary												
HCM 2000 Control Delay			14.9				HCM 2000 Level of Service			B		
HCM 2000 Volume to Capacity ratio			0.67									
Actuated Cycle Length (s)			160.0				Sum of lost time (s)			25.0		
Intersection Capacity Utilization			67.5%				ICU Level of Service			C		
Analysis Period (min)			15									
c Critical Lane Group												

HCM 6th Signalized Intersection Summary

104: SR 7 & Margate Boulevard

HCM 6th Edition methodology expects strict NEMA phasing.

Timings

105: Riverside Drive & Atlantic Boulevard /Atlantic Boulevard

Lane Group	EBL	EBT	EBR	WBL	WBT	WBR	NBL	NBT	NBR	SBL	SBT	SBR
Lane Configurations												
Traffic Volume (vph)	149	919	61	235	870	310	55	643	226	294	474	171
Future Volume (vph)	149	919	61	235	870	310	55	643	226	294	474	171
Turn Type	Prot	NA	Perm	Prot	NA	Perm	Prot	NA	Perm	Prot	NA	Perm
Protected Phases	1	6		5	2		7	4		3	8	
Permitted Phases			6			2			4			8
Detector Phase	1	6	6	5	2	2	7	4	4	3	8	8
Switch Phase												
Minimum Initial (s)	5.0	12.0	12.0	5.0	12.0	12.0	4.0	6.0	6.0	5.0	6.0	6.0
Minimum Split (s)	11.0	36.0	36.0	24.0	36.0	36.0	10.0	32.0	32.0	11.0	20.0	20.0
Total Split (s)	60.0	50.0	50.0	60.0	50.0	50.0	30.0	32.0	32.0	18.0	20.0	20.0
Total Split (%)	37.5%	31.3%	31.3%	37.5%	31.3%	31.3%	18.8%	20.0%	20.0%	11.3%	12.5%	12.5%
Yellow Time (s)	4.0	5.0	5.0	4.0	5.0	5.0	4.0	5.0	5.0	4.0	5.0	5.0
All-Red Time (s)	2.0	2.0	2.0	2.0	2.0	2.0	2.0	2.0	2.0	2.0	2.0	2.0
Lost Time Adjust (s)	0.0	0.0	0.0	0.0	0.0	0.0	0.0	0.0	0.0	0.0	0.0	0.0
Total Lost Time (s)	6.0	7.0	7.0	6.0	7.0	7.0	6.0	7.0	7.0	6.0	7.0	7.0
Lead/Lag	Lead	Lag	Lag	Lead	Lag	Lag	Lead	Lag	Lag	Lead	Lag	Lag
Lead-Lag Optimize?	Yes	Yes	Yes	Yes	Yes	Yes	Yes	Yes	Yes	Yes	Yes	Yes
Recall Mode	None	C-Max	C-Max	None	C-Max	C-Max	None	None	None	None	None	None
Act Effct Green (s)	11.2	81.7	81.7	15.3	85.8	85.8	6.6	25.0	25.0	12.0	32.5	32.5
Actuated g/C Ratio	0.07	0.51	0.51	0.10	0.54	0.54	0.04	0.16	0.16	0.08	0.20	0.20
v/c Ratio	0.64	0.36	0.07	0.74	0.33	0.32	0.40	1.20	0.53	1.18	0.68	0.39
Control Delay	84.6	24.4	0.2	106.1	13.8	4.3	82.7	161.9	11.7	173.6	65.4	9.8
Queue Delay	0.0	0.0	0.0	0.0	0.0	0.0	0.0	0.0	0.0	0.0	0.0	0.0
Total Delay	84.6	24.4	0.2	106.1	13.8	4.3	82.7	161.9	11.7	173.6	65.4	9.8
LOS	F	C	A	F	B	A	F	F	B	F	E	A
Approach Delay		31.1			27.0			120.4			89.2	
Approach LOS		C			C			F			F	

Intersection Summary

Cycle Length: 160
 Actuated Cycle Length: 160
 Offset: 0 (0%), Referenced to phase 2:WBT and 6:EBT, Start of Yellow
 Natural Cycle: 105
 Control Type: Actuated-Coordinated
 Maximum v/c Ratio: 1.20
 Intersection Signal Delay: 60.9
 Intersection Capacity Utilization 73.2%
 Analysis Period (min) 15





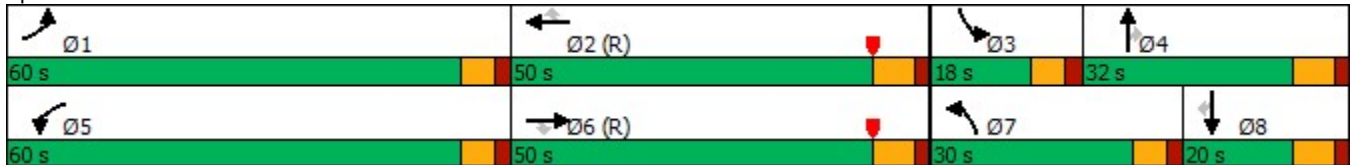







Intersection LOS: E
 ICU Level of Service D

Splits and Phases: 105: Riverside Drive & Atlantic Boulevard /Atlantic Boulevard



Queues

105: Riverside Drive & Atlantic Boulevard /Atlantic Boulevard

												
Lane Group	EBL	EBT	EBR	WBL	WBT	WBR	NBL	NBT	NBR	SBL	SBT	SBR
Lane Group Flow (vph)	154	947	63	242	897	320	57	663	233	303	489	176
v/c Ratio	0.64	0.36	0.07	0.74	0.33	0.32	0.40	1.20	0.53	1.18	0.68	0.39
Control Delay	84.6	24.4	0.2	106.1	13.8	4.3	82.7	161.9	11.7	173.6	65.4	9.8
Queue Delay	0.0	0.0	0.0	0.0	0.0	0.0	0.0	0.0	0.0	0.0	0.0	0.0
Total Delay	84.6	24.4	0.2	106.1	13.8	4.3	82.7	161.9	11.7	173.6	65.4	9.8
Queue Length 50th (ft)	82	213	0	138	115	46	30	~441	2	~194	256	0
Queue Length 95th (ft)	120	264	0	186	145	83	55	#572	85	#297	329	71
Internal Link Dist (ft)		1763			2560			1528			1193	
Turn Bay Length (ft)	250		300	220		270	300		300	300		300
Base Capacity (vph)	1158	2595	871	1158	2728	997	514	552	438	257	718	456
Starvation Cap Reductn	0	0	0	0	0	0	0	0	0	0	0	0
Spillback Cap Reductn	0	0	0	0	0	0	0	0	0	0	0	0
Storage Cap Reductn	0	0	0	0	0	0	0	0	0	0	0	0
Reduced v/c Ratio	0.13	0.36	0.07	0.21	0.33	0.32	0.11	1.20	0.53	1.18	0.68	0.39

Intersection Summary

~ Volume exceeds capacity, queue is theoretically infinite.



































Queue shown is maximum after two cycles.

95th percentile volume exceeds capacity, queue may be longer.

Queue shown is maximum after two cycles.

HCM 6th Signalized Intersection Summary

105: Riverside Drive & Atlantic Boulevard /Atlantic Boulevard

												
Movement	EBL	EBT	EBR	WBL	WBT	WBR	NBL	NBT	NBR	SBL	SBT	SBR
Lane Configurations	 	  		 	  		 	 		 	 	
Traffic Volume (veh/h)	149	919	61	235	870	310	55	643	226	294	474	171
Future Volume (veh/h)	149	919	61	235	870	310	55	643	226	294	474	171
Initial Q (Qb), veh	0	0	0	0	0	0	0	0	0	0	0	0
Ped-Bike Adj(A_pbT)	1.00		0.99	1.00		1.00	1.00		0.99	1.00		0.98
Parking Bus, Adj	1.00	1.00	1.00	1.00	1.00	1.00	1.00	1.00	1.00	1.00	1.00	1.00
Work Zone On Approach		No			No			No			No	
Adj Sat Flow, veh/h/ln	1870	1870	1870	1870	1870	1870	1870	1870	1870	1870	1870	1870
Adj Flow Rate, veh/h	154	947	63	242	897	320	57	663	233	303	489	176
Peak Hour Factor	0.97	0.97	0.97	0.97	0.97	0.97	0.97	0.97	0.97	0.97	0.97	0.97
Percent Heavy Veh, %	2	2	2	2	2	2	2	2	2	2	2	2
Cap, veh/h	198	2672	819	287	2803	870	93	555	246	259	727	318
Arrive On Green	0.08	0.70	0.70	0.11	0.73	0.73	0.03	0.16	0.16	0.08	0.20	0.20
Sat Flow, veh/h	3456	5106	1565	3456	5106	1585	3456	3554	1576	3456	3554	1557
Grp Volume(v), veh/h	154	947	63	242	897	320	57	663	233	303	489	176
Grp Sat Flow(s),veh/h/ln	1728	1702	1565	1728	1702	1585	1728	1777	1576	1728	1777	1557
Q Serve(g_s), s	7.0	12.0	2.1	11.0	9.9	11.9	2.6	25.0	23.4	12.0	20.3	16.2
Cycle Q Clear(g_c), s	7.0	12.0	2.1	11.0	9.9	11.9	2.6	25.0	23.4	12.0	20.3	16.2
Prop In Lane	1.00		1.00	1.00		1.00	1.00		1.00	1.00		1.00
Lane Grp Cap(c), veh/h	198	2672	819	287	2803	870	93	555	246	259	727	318
V/C Ratio(X)	0.78	0.35	0.08	0.84	0.32	0.37	0.62	1.19	0.95	1.17	0.67	0.55
Avail Cap(c_a), veh/h	1166	2672	819	1166	2803	870	518	555	246	259	727	318
HCM Platoon Ratio	1.33	1.33	1.33	1.33	1.33	1.33	1.00	1.00	1.00	1.00	1.00	1.00
Upstream Filter(I)	1.00	1.00	1.00	0.87	0.87	0.87	1.00	1.00	1.00	1.00	1.00	1.00
Uniform Delay (d), s/veh	72.9	13.4	11.9	70.1	11.1	11.4	77.0	67.5	66.8	74.0	58.7	57.1
Incr Delay (d2), s/veh	2.5	0.4	0.2	2.3	0.3	1.0	2.5	104.1	42.2	109.5	2.0	1.2
Initial Q Delay(d3),s/veh	0.0	0.0	0.0	0.0	0.0	0.0	0.0	0.0	0.0	0.0	0.0	0.0
%ile BackOfQ(50%),veh/ln	3.1	4.3	0.8	4.9	3.5	4.0	1.2	19.4	12.4	9.3	9.4	6.5
Unsig. Movement Delay, s/veh												
LnGrp Delay(d),s/veh	75.4	13.8	12.1	72.4	11.3	12.4	79.5	171.6	109.1	183.5	60.7	58.3
LnGrp LOS	E	B	B	E	B	B	E	F	F	F	E	E
Approach Vol, veh/h		1164			1459			953			968	
Approach Delay, s/veh		21.8			21.7			150.8			98.7	
Approach LOS		C			C			F			F	
Timer - Assigned Phs	1	2	3	4	5	6	7	8				
Phs Duration (G+Y+Rc), s	15.2	94.8	18.0	32.0	19.3	90.7	10.3	39.7				
Change Period (Y+Rc), s	6.0	7.0	6.0	7.0	6.0	7.0	6.0	7.0				
Max Green Setting (Gmax), s	54.0	43.0	12.0	25.0	54.0	43.0	24.0	13.0				
Max Q Clear Time (g_c+I1), s	9.0	13.9	14.0	27.0	13.0	14.0	4.6	22.3				
Green Ext Time (p_c), s	0.2	8.7	0.0	0.0	0.3	8.0	0.0	0.0				
Intersection Summary												
HCM 6th Ctrl Delay			65.2									
HCM 6th LOS			E									
Notes												
User approved pedestrian interval to be less than phase max green.												

Timings

106: Ramblewood Drive & Atlantic Boulevard

Lane Group	EBL	EBT	WBL	WBT	NBL	NBT	NBR	SBL	SBT	SBR
Lane Configurations										
Traffic Volume (vph)	47	1349	91	1585	20	8	22	108	15	52
Future Volume (vph)	47	1349	91	1585	20	8	22	108	15	52
Turn Type	pm+pt	NA	pm+pt	NA	Perm	NA	Perm	Perm	NA	Perm
Protected Phases	1	6	5	2		4			8	
Permitted Phases	6		2		4		4	8		8
Detector Phase	1	6	5	2	4	4	4	8	8	8
Switch Phase										
Minimum Initial (s)	4.0	12.0	4.0	12.0	6.0	6.0	6.0	6.0	6.0	6.0
Minimum Split (s)	11.0	45.0	11.0	45.0	36.0	36.0	36.0	36.0	36.0	36.0
Total Split (s)	25.0	85.0	25.0	85.0	50.0	50.0	50.0	50.0	50.0	50.0
Total Split (%)	15.6%	53.1%	15.6%	53.1%	31.3%	31.3%	31.3%	31.3%	31.3%	31.3%
Yellow Time (s)	5.0	5.0	5.0	5.0	4.0	4.0	4.0	4.0	4.0	4.0
All-Red Time (s)	2.0	2.0	2.0	2.0	2.0	2.0	2.0	2.0	2.0	2.0
Lost Time Adjust (s)	0.0	0.0	0.0	0.0	0.0	0.0	0.0	0.0	0.0	0.0
Total Lost Time (s)	7.0	7.0	7.0	7.0	6.0	6.0	6.0	6.0	6.0	6.0
Lead/Lag	Lead	Lag	Lead	Lag						
Lead-Lag Optimize?	Yes	Yes	Yes	Yes						
Recall Mode	None	C-Max	None	C-Max	None	None	None	None	None	None
Act Effct Green (s)	120.9	115.4	123.2	118.2	18.6	18.6	18.6	18.6	18.6	18.6
Actuated g/C Ratio	0.76	0.72	0.77	0.74	0.12	0.12	0.12	0.12	0.12	0.12
v/c Ratio	0.27	0.40	0.36	0.50	0.13	0.02	0.09	0.71	0.07	0.22
Control Delay	6.8	2.1	6.7	2.6	62.3	59.0	0.7	90.3	60.5	7.2
Queue Delay	0.0	0.0	0.0	0.0	0.0	0.0	0.0	0.0	0.0	0.0
Total Delay	6.8	2.1	6.7	2.6	62.3	59.0	0.7	90.3	60.5	7.2
LOS	A	A	A	A	E	E	A	F	E	A
Approach Delay		2.3		2.8		35.0			63.2	
Approach LOS		A		A		D			E	

Intersection Summary

Cycle Length: 160
 Actuated Cycle Length: 160
 Offset: 80 (50%), Referenced to phase 2:WBTL and 6:EBTL, Start of Yellow
 Natural Cycle: 95
 Control Type: Actuated-Coordinated
 Maximum v/c Ratio: 0.71
 Intersection Signal Delay: 6.1
 Intersection Capacity Utilization 67.4%
 Analysis Period (min) 15

Intersection LOS: A
 ICU Level of Service C

Splits and Phases: 106: Ramblewood Drive & Atlantic Boulevard

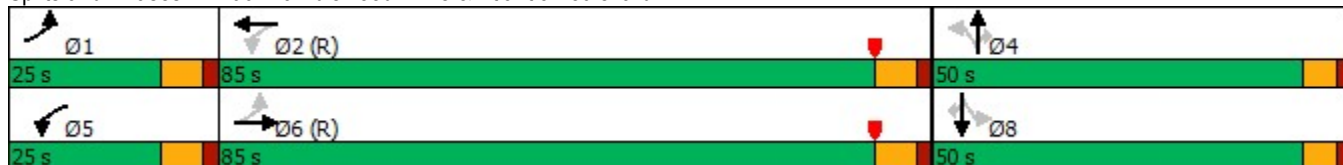

Queues

106: Ramblewood Drive & Atlantic Boulevard





























Lane Group	EBL	EBT	WBL	WBT	NBL	NBT	NBR	SBL	SBT	SBR
Lane Group Flow (vph)	50	1472	97	1842	21	9	23	115	16	55
v/c Ratio	0.27	0.40	0.36	0.50	0.13	0.02	0.09	0.71	0.07	0.22
Control Delay	6.8	2.1	6.7	2.6	62.3	59.0	0.7	90.3	60.5	7.2
Queue Delay	0.0	0.0	0.0	0.0	0.0	0.0	0.0	0.0	0.0	0.0
Total Delay	6.8	2.1	6.7	2.6	62.3	59.0	0.7	90.3	60.5	7.2
Queue Length 50th (ft)	2	27	3	25	20	4	0	118	15	0
Queue Length 95th (ft)	m10	m54	21	44	47	13	0	182	38	24
Internal Link Dist (ft)		2560		3088		436			532	
Turn Bay Length (ft)	180		180		200		425	180		275
Base Capacity (vph)	321	3655	389	3705	381	973	483	384	512	483
Starvation Cap Reductn	0	0	0	0	0	0	0	0	0	0
Spillback Cap Reductn	0	0	0	0	0	0	0	0	0	0
Storage Cap Reductn	0	0	0	0	0	0	0	0	0	0
Reduced v/c Ratio	0.16	0.40	0.25	0.50	0.06	0.01	0.05	0.30	0.03	0.11

Intersection Summary

m Volume for 95th percentile queue is metered by upstream signal.

HCM 6th Signalized Intersection Summary

106: Ramblewood Drive & Atlantic Boulevard

													
Movement	EBL	EBT	EBR	WBL	WBT	WBR	NBL	NBT	NBR	SBL	SBT	SBR	
Lane Configurations		 			 			 				 	
Traffic Volume (veh/h)	47	1349	35	91	1585	147	20	8	22	108	15	52	
Future Volume (veh/h)	47	1349	35	91	1585	147	20	8	22	108	15	52	
Initial Q (Qb), veh	0	0	0	0	0	0	0	0	0	0	0	0	
Ped-Bike Adj(A_pbT)	1.00		1.00	1.00		0.99	1.00		0.99	0.99		0.99	
Parking Bus, Adj	1.00	1.00	1.00	1.00	1.00	1.00	1.00	1.00	1.00	1.00	1.00	1.00	
Work Zone On Approach		No			No			No			No		
Adj Sat Flow, veh/h/ln	1870	1870	1870	1870	1870	1870	1870	1870	1870	1870	1870	1870	
Adj Flow Rate, veh/h	50	1435	37	97	1686	156	21	9	23	115	16	55	
Peak Hour Factor	0.94	0.94	0.94	0.94	0.94	0.94	0.94	0.94	0.94	0.94	0.94	0.94	
Percent Heavy Veh, %	2	2	2	2	2	2	2	2	2	2	2	2	
Cap, veh/h	270	3793	98	355	3538	327	178	383	170	190	202	170	
Arrive On Green	0.03	0.99	0.99	0.03	0.99	0.99	0.11	0.11	0.11	0.11	0.11	0.11	
Sat Flow, veh/h	1781	5118	132	1781	4750	439	1323	3554	1576	1370	1870	1576	
Grp Volume(v), veh/h	50	954	518	97	1207	635	21	9	23	115	16	55	
Grp Sat Flow(s),veh/h/ln	1781	1702	1846	1781	1702	1784	1323	1777	1576	1370	1870	1576	
Q Serve(g_s), s	1.1	1.0	1.0	2.2	1.0	1.0	2.3	0.4	2.1	13.1	1.2	5.2	
Cycle Q Clear(g_c), s	1.1	1.0	1.0	2.2	1.0	1.0	3.6	0.4	2.1	13.5	1.2	5.2	
Prop In Lane	1.00		0.07	1.00		0.25	1.00		1.00	1.00		1.00	
Lane Grp Cap(c), veh/h	270	2523	1368	355	2535	1329	178	383	170	190	202	170	
V/C Ratio(X)	0.19	0.38	0.38	0.27	0.48	0.48	0.12	0.02	0.14	0.61	0.08	0.32	
Avail Cap(c_a), veh/h	431	2523	1368	509	2535	1329	399	977	433	419	514	433	
HCM Platoon Ratio	1.33	1.33	1.33	1.33	1.33	1.33	1.00	1.00	1.00	1.00	1.00	1.00	
Upstream Filter(l)	0.81	0.81	0.81	0.85	0.85	0.85	1.00	1.00	1.00	1.00	1.00	1.00	
Uniform Delay (d), s/veh	4.6	0.3	0.3	4.6	0.2	0.2	65.8	63.8	64.6	69.9	64.2	66.0	
Incr Delay (d2), s/veh	0.1	0.4	0.6	0.1	0.5	1.0	0.3	0.0	0.4	3.1	0.2	1.1	
Initial Q Delay(d3),s/veh	0.0	0.0	0.0	0.0	0.0	0.0	0.0	0.0	0.0	0.0	0.0	0.0	
%ile BackOfQ(50%),veh/ln	0.4	0.4	0.5	0.8	0.4	0.6	0.8	0.2	0.9	4.8	0.6	2.1	
Unsig. Movement Delay, s/veh													
LnGrp Delay(d),s/veh	4.7	0.7	1.0	4.7	0.7	1.2	66.1	63.9	65.0	73.0	64.4	67.1	
LnGrp LOS	A	A	A	A	A	A	E	E	E	E	E	E	
Approach Vol, veh/h		1522			1939			53			186		
Approach Delay, s/veh		0.9			1.1			65.2			70.5		
Approach LOS		A			A			E			E		
Timer - Assigned Phs	1	2		4	5	6		8					
Phs Duration (G+Y+Rc), s	10.6	126.2		23.3	11.2	125.6		23.3					
Change Period (Y+Rc), s	7.0	7.0		6.0	7.0	7.0		6.0					
Max Green Setting (Gmax), s	18.0	78.0		44.0	18.0	78.0		44.0					
Max Q Clear Time (g_c+I1), s	3.1	3.0		5.6	4.2	3.0		15.5					
Green Ext Time (p_c), s	0.0	25.4		0.2	0.1	16.2		0.6					
Intersection Summary													
HCM 6th Ctrl Delay			5.4										
HCM 6th LOS			A										

Timings

107: NW 76 Avenue & Atlantic Boulevard



Lane Group	EBL	EBT	WBL	WBT	NBL	NBT	SBL	SBT	SBR
Lane Configurations	↖	↕↕↕↗	↖	↕↕↕↗	↖	↗	↖	↕	↗
Traffic Volume (vph)	114	1397	6	1730	31	9	61	6	136
Future Volume (vph)	114	1397	6	1730	31	9	61	6	136
Turn Type	Prot	NA	Prot	NA	Perm	NA	Perm	NA	Perm
Protected Phases	1	6	5	2		4		8	
Permitted Phases					4		8		8
Detector Phase	1	6	5	2	4	4	8	8	8
Switch Phase									
Minimum Initial (s)	4.0	12.0	4.0	12.0	6.0	6.0	6.0	6.0	6.0
Minimum Split (s)	24.0	28.0	10.0	28.0	43.0	43.0	43.0	43.0	43.0
Total Split (s)	25.0	98.0	16.0	89.0	46.0	46.0	46.0	46.0	46.0
Total Split (%)	15.6%	61.3%	10.0%	55.6%	28.8%	28.8%	28.8%	28.8%	28.8%
Yellow Time (s)	4.0	4.0	4.0	4.0	4.0	4.0	4.0	4.0	4.0
All-Red Time (s)	2.0	2.0	2.0	2.0	2.0	2.0	2.0	2.0	2.0
Lost Time Adjust (s)	0.0	0.0	0.0	0.0	0.0	0.0	0.0	0.0	0.0
Total Lost Time (s)	6.0	6.0	6.0	6.0	6.0	6.0	6.0	6.0	6.0
Lead/Lag	Lead	Lag	Lead	Lag					
Lead-Lag Optimize?	Yes	Yes	Yes	Yes					
Recall Mode	None	C-Max	None	C-Max	None	None	None	None	None
Act Effct Green (s)	14.3	134.0	4.7	116.0	11.6	11.6	11.6	11.6	11.6
Actuated g/C Ratio	0.09	0.84	0.03	0.72	0.07	0.07	0.07	0.07	0.07
v/c Ratio	0.73	0.35	0.12	0.51	0.31	0.16	0.62	0.04	0.57
Control Delay	114.0	1.2	61.8	8.1	76.6	41.6	96.7	66.5	19.3
Queue Delay	0.0	0.0	0.0	0.0	0.0	0.0	0.0	0.0	0.0
Total Delay	114.0	1.2	61.8	8.1	76.6	41.6	96.7	66.5	19.3
LOS	F	A	E	A	E	D	F	E	B
Approach Delay		9.5		8.2		62.7		43.9	
Approach LOS		A		A		E		D	

Intersection Summary

Cycle Length: 160
 Actuated Cycle Length: 160
 Offset: 5 (3%), Referenced to phase 2:WBT and 6:EBT, Start of Yellow
 Natural Cycle: 105
 Control Type: Actuated-Coordinated
 Maximum v/c Ratio: 0.73
 Intersection Signal Delay: 11.5
 Intersection Capacity Utilization 68.3%
 Analysis Period (min) 15

Intersection LOS: B
 ICU Level of Service C

Splits and Phases: 107: NW 76 Avenue & Atlantic Boulevard



Queues

107: NW 76 Avenue & Atlantic Boulevard























Lane Group	EBL	EBT	WBL	WBT	NBL	NBT	SBL	SBT	SBR
Lane Group Flow (vph)	116	1463	6	1872	32	21	62	6	139
v/c Ratio	0.73	0.35	0.12	0.51	0.31	0.16	0.62	0.04	0.57
Control Delay	114.0	1.2	61.8	8.1	76.6	41.6	96.7	66.5	19.3
Queue Delay	0.0	0.0	0.0	0.0	0.0	0.0	0.0	0.0	0.0
Total Delay	114.0	1.2	61.8	8.1	76.6	41.6	96.7	66.5	19.3
Queue Length 50th (ft)	122	24	7	157	32	9	64	6	0
Queue Length 95th (ft)	184	36	m6	184	68	38	115	22	69
Internal Link Dist (ft)		3088		2032		396		487	
Turn Bay Length (ft)	150		200		225		200		200
Base Capacity (vph)	212	4239	110	3652	351	430	344	465	495
Starvation Cap Reductn	0	0	0	0	0	0	0	0	0
Spillback Cap Reductn	0	0	0	0	0	0	0	0	0
Storage Cap Reductn	0	0	0	0	0	0	0	0	0
Reduced v/c Ratio	0.55	0.35	0.05	0.51	0.09	0.05	0.18	0.01	0.28

Intersection Summary

m Volume for 95th percentile queue is metered by upstream signal.

HCM 6th Signalized Intersection Summary

107: NW 76 Avenue & Atlantic Boulevard

												
Movement	EBL	EBT	EBR	WBL	WBT	WBR	NBL	NBT	NBR	SBL	SBT	SBR
Lane Configurations												
Traffic Volume (veh/h)	114	1397	36	6	1730	105	31	9	12	61	6	136
Future Volume (veh/h)	114	1397	36	6	1730	105	31	9	12	61	6	136
Initial Q (Qb), veh	0	0	0	0	0	0	0	0	0	0	0	0
Ped-Bike Adj(A_pbT)	1.00		0.98	1.00		1.00	0.99		0.99	0.99		0.98
Parking Bus, Adj	1.00	1.00	1.00	1.00	1.00	1.00	1.00	1.00	1.00	1.00	1.00	1.00
Work Zone On Approach		No			No			No			No	
Adj Sat Flow, veh/h/ln	1870	1870	1870	1870	1870	1870	1870	1870	1870	1870	1870	1870
Adj Flow Rate, veh/h	116	1426	37	6	1765	107	32	9	12	62	6	139
Peak Hour Factor	0.98	0.98	0.98	0.98	0.98	0.98	0.98	0.98	0.98	0.98	0.98	0.98
Percent Heavy Veh, %	2	2	2	2	2	2	2	2	2	2	2	2
Cap, veh/h	137	3882	101	10	3387	205	193	89	118	199	230	190
Arrive On Green	0.10	1.00	1.00	0.01	0.92	0.92	0.12	0.12	0.12	0.12	0.12	0.12
Sat Flow, veh/h	1781	5114	133	1781	4923	298	1233	722	963	1378	1870	1548
Grp Volume(v), veh/h	116	949	514	6	1220	652	32	0	21	62	6	139
Grp Sat Flow(s),veh/h/ln	1781	1702	1843	1781	1702	1816	1233	0	1686	1378	1870	1548
Q Serve(g_s), s	10.2	0.0	0.0	0.5	9.3	9.3	3.8	0.0	1.8	6.7	0.5	13.8
Cycle Q Clear(g_c), s	10.2	0.0	0.0	0.5	9.3	9.3	4.2	0.0	1.8	8.5	0.5	13.8
Prop In Lane	1.00		0.07	1.00		0.16	1.00		0.57	1.00		1.00
Lane Grp Cap(c), veh/h	137	2583	1399	10	2342	1250	193	0	207	199	230	190
V/C Ratio(X)	0.85	0.37	0.37	0.58	0.52	0.52	0.17	0.00	0.10	0.31	0.03	0.73
Avail Cap(c_a), veh/h	212	2583	1399	111	2342	1250	350	0	421	374	468	387
HCM Platoon Ratio	1.33	1.33	1.33	1.33	1.33	1.33	1.00	1.00	1.00	1.00	1.00	1.00
Upstream Filter(I)	0.91	0.91	0.91	0.31	0.31	0.31	1.00	0.00	1.00	1.00	1.00	1.00
Uniform Delay (d), s/veh	70.9	0.0	0.0	79.2	2.5	2.5	63.6	0.0	62.3	66.1	61.8	67.6
Incr Delay (d2), s/veh	9.9	0.4	0.7	5.6	0.3	0.5	0.1	0.0	0.1	0.3	0.0	2.0
Initial Q Delay(d3),s/veh	0.0	0.0	0.0	0.0	0.0	0.0	0.0	0.0	0.0	0.0	0.0	0.0
%ile BackOfQ(50%),veh/ln	5.0	0.1	0.3	0.3	2.1	2.3	1.2	0.0	0.8	2.4	0.2	5.6
Unsig. Movement Delay, s/veh												
LnGrp Delay(d),s/veh	80.8	0.4	0.7	84.8	2.8	3.0	63.8	0.0	62.4	66.4	61.8	69.7
LnGrp LOS	F	A	A	F	A	A	E	A	E	E	E	E
Approach Vol, veh/h		1579			1878			53			207	
Approach Delay, s/veh		6.4			3.1			63.2			68.5	
Approach LOS		A			A			E			E	
Timer - Assigned Phs	1	2		4	5	6		8				
Phs Duration (G+Y+Rc), s	18.3	116.1		25.6	6.9	127.4		25.6				
Change Period (Y+Rc), s	6.0	6.0		6.0	6.0	6.0		6.0				
Max Green Setting (Gmax), s	19.0	83.0		40.0	10.0	92.0		40.0				
Max Q Clear Time (g_c+I1), s	12.2	11.3		6.2	2.5	2.0		15.8				
Green Ext Time (p_c), s	0.0	25.8		0.1	0.0	16.2		0.3				
Intersection Summary												
HCM 6th Ctrl Delay				9.0								
HCM 6th LOS				A								

Timings

108: Rock Island Road & Atlantic Boulevard/Atlantic Boulevard



Lane Group	EBL	EBT	WBL	WBT	NBL	NBT	NBR	SBL	SBT
Lane Configurations	↖↗	↕↔	↖↗	↕↔	↖↗	↕↔	↗	↖↗	↕↔
Traffic Volume (vph)	210	938	481	1394	351	720	299	137	755
Future Volume (vph)	210	938	481	1394	351	720	299	137	755
Turn Type	Prot	NA	Prot	NA	Prot	NA	Perm	Prot	NA
Protected Phases	1	6	5	2	7	4		3	8
Permitted Phases							4		
Detector Phase	1	6	5	2	7	4	4	3	8
Switch Phase									
Minimum Initial (s)	5.0	12.0	5.0	12.0	5.0	6.0	6.0	5.0	6.0
Minimum Split (s)	11.0	49.0	11.0	49.0	11.5	51.5	51.5	11.5	51.5
Total Split (s)	27.0	54.0	27.0	54.0	27.0	56.0	56.0	23.0	52.0
Total Split (%)	16.9%	33.8%	16.9%	33.8%	16.9%	35.0%	35.0%	14.4%	32.5%
Yellow Time (s)	4.0	4.0	4.0	4.0	4.5	4.5	4.5	4.5	4.5
All-Red Time (s)	2.0	2.0	2.0	2.0	2.0	2.0	2.0	2.0	2.0
Lost Time Adjust (s)	0.0	0.0	0.0	0.0	0.0	0.0	0.0	0.0	0.0
Total Lost Time (s)	6.0	6.0	6.0	6.0	6.5	6.5	6.5	6.5	6.5
Lead/Lag	Lead	Lag	Lead	Lag	Lead	Lag	Lag	Lead	Lag
Lead-Lag Optimize?	Yes	Yes	Yes	Yes	Yes	Yes	Yes	Yes	Yes
Recall Mode	None	C-Max	None	C-Max	None	None	None	None	None
Act Effct Green (s)	14.2	48.0	22.7	56.5	19.4	53.7	53.7	10.6	44.9
Actuated g/C Ratio	0.09	0.30	0.14	0.35	0.12	0.34	0.34	0.07	0.28
v/c Ratio	0.73	0.84	1.04	0.91	0.89	0.64	0.52	0.63	0.95
Control Delay	81.2	56.7	99.4	81.4	80.1	39.6	24.0	101.9	62.1
Queue Delay	0.0	0.0	0.0	0.0	0.0	0.0	0.0	0.0	0.0
Total Delay	81.2	56.7	99.4	81.4	80.1	39.6	24.0	101.9	62.1
LOS	F	E	F	F	F	D	C	F	E
Approach Delay		60.3		85.7		46.6			67.4
Approach LOS		E		F		D			E

Intersection Summary

Cycle Length: 160
 Actuated Cycle Length: 160
 Offset: 109 (68%), Referenced to phase 2:WBT and 6:EBT, Start of Yellow
 Natural Cycle: 145
 Control Type: Actuated-Coordinated
 Maximum v/c Ratio: 1.04
 Intersection Signal Delay: 67.1
 Intersection Capacity Utilization 98.5%
 Analysis Period (min) 15
 Intersection LOS: E
 ICU Level of Service F

Splits and Phases: 108: Rock Island Road & Atlantic Boulevard/Atlantic Boulevard

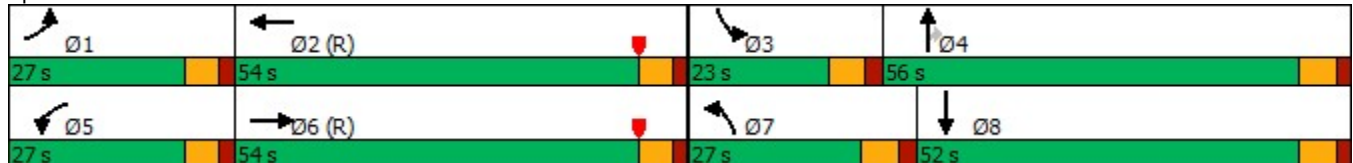

Queues

108: Rock Island Road & Atlantic Boulevard/Atlantic Boulevard



Lane Group	EBL	EBT	WBL	WBT	NBL	NBT	NBR	SBL	SBT
Lane Group Flow (vph)	221	1272	506	1608	369	758	315	144	930
v/c Ratio	0.73	0.84	1.04	0.91	0.89	0.64	0.52	0.63	0.95
Control Delay	81.2	56.7	99.4	81.4	80.1	39.6	24.0	101.9	62.1
Queue Delay	0.0	0.0	0.0	0.0	0.0	0.0	0.0	0.0	0.0
Total Delay	81.2	56.7	99.4	81.4	80.1	39.6	24.0	101.9	62.1
Queue Length 50th (ft)	124	335	~319	592	203	337	175	82	490
Queue Length 95th (ft)	170	413	m#318	m586	m#264	m488	m260	m118	#631
Internal Link Dist (ft)		2032		5200		2618			3616
Turn Bay Length (ft)	300		300		210		23	200	
Base Capacity (vph)	450	1506	486	1776	439	1188	602	354	995
Starvation Cap Reductn	0	0	0	0	0	0	0	0	0
Spillback Cap Reductn	0	0	0	0	0	0	0	0	0
Storage Cap Reductn	0	0	0	0	0	0	0	0	0
Reduced v/c Ratio	0.49	0.84	1.04	0.91	0.84	0.64	0.52	0.41	0.93

Intersection Summary

~ Volume exceeds capacity, queue is theoretically infinite.

Queue shown is maximum after two cycles.

































95th percentile volume exceeds capacity, queue may be longer.

Queue shown is maximum after two cycles.

m Volume for 95th percentile queue is metered by upstream signal.

HCM 6th Signalized Intersection Summary

108: Rock Island Road & Atlantic Boulevard/Atlantic Boulevard

												
Movement	EBL	EBT	EBR	WBL	WBT	WBR	NBL	NBT	NBR	SBL	SBT	SBR
Lane Configurations	 	 		 	 		 	 	 	  	 	 
Traffic Volume (veh/h)	210	938	271	481	1394	134	351	720	299	137	755	128
Future Volume (veh/h)	210	938	271	481	1394	134	351	720	299	137	755	128
Initial Q (Qb), veh	0	0	0	0	0	0	0	0	0	0	0	0
Ped-Bike Adj(A_pbT)	1.00		1.00	1.00		0.99	1.00		1.00	1.00		1.00
Parking Bus, Adj	1.00	1.00	1.00	1.00	1.00	1.00	1.00	1.00	1.00	1.00	1.00	1.00
Work Zone On Approach		No			No			No			No	
Adj Sat Flow, veh/h/ln	1870	1870	1870	1870	1870	1870	1870	1870	1870	1870	1870	1870
Adj Flow Rate, veh/h	221	987	285	506	1467	141	369	758	315	144	795	135
Peak Hour Factor	0.95	0.95	0.95	0.95	0.95	0.95	0.95	0.95	0.95	0.95	0.95	0.95
Percent Heavy Veh, %	2	2	2	2	2	2	2	2	2	2	2	2
Cap, veh/h	264	1246	359	454	1757	169	413	1214	541	187	839	143
Arrive On Green	0.10	0.42	0.42	0.17	0.49	0.49	0.04	0.11	0.11	0.05	0.28	0.28
Sat Flow, veh/h	3456	3935	1134	3456	4731	455	3456	3554	1582	3456	3037	516
Grp Volume(v), veh/h	221	854	418	506	1055	553	369	758	315	144	465	465
Grp Sat Flow(s),veh/h/ln	1728	1702	1665	1728	1702	1781	1728	1777	1582	1728	1777	1776
Q Serve(g_s), s	10.0	34.8	34.9	21.0	42.7	42.7	17.0	32.6	30.2	6.6	41.0	41.1
Cycle Q Clear(g_c), s	10.0	34.8	34.9	21.0	42.7	42.7	17.0	32.6	30.2	6.6	41.0	41.1
Prop In Lane	1.00		0.68	1.00		0.26	1.00		1.00	1.00		0.29
Lane Grp Cap(c), veh/h	264	1078	527	454	1265	662	413	1214	541	187	491	491
V/C Ratio(X)	0.84	0.79	0.79	1.12	0.83	0.84	0.89	0.62	0.58	0.77	0.95	0.95
Avail Cap(c_a), veh/h	454	1078	527	454	1265	662	443	1214	541	356	505	505
HCM Platoon Ratio	1.33	1.33	1.33	1.33	1.33	1.33	0.33	0.33	0.33	1.00	1.00	1.00
Upstream Filter(I)	0.94	0.94	0.94	0.09	0.09	0.09	0.65	0.65	0.65	0.90	0.90	0.90
Uniform Delay (d), s/veh	70.9	41.7	41.8	66.0	36.2	36.2	75.8	61.2	60.1	74.7	56.7	56.7
Incr Delay (d2), s/veh	2.5	5.6	11.0	55.3	0.6	1.2	13.0	0.5	0.7	2.3	24.7	24.7
Initial Q Delay(d3),s/veh	0.0	0.0	0.0	0.0	0.0	0.0	0.0	0.0	0.0	0.0	0.0	0.0
%ile BackOfQ(50%),veh/ln	4.5	14.9	15.4	12.5	16.9	17.8	8.7	15.8	13.1	3.0	21.8	21.8
Unsig. Movement Delay, s/veh												
LnGrp Delay(d),s/veh	73.4	47.4	52.8	121.3	36.9	37.5	88.9	61.7	60.8	77.0	81.5	81.5
LnGrp LOS	E	D	D	F	D	D	F	E	E	E	F	F
Approach Vol, veh/h		1493			2114			1442			1074	
Approach Delay, s/veh		52.7			57.2			68.4			80.9	
Approach LOS		D			E			E			F	
Timer - Assigned Phs	1	2	3	4	5	6	7	8				
Phs Duration (G+Y+Rc), s	18.2	65.4	15.2	61.2	27.0	56.7	25.6	50.7				
Change Period (Y+Rc), s	6.0	6.0	6.5	6.5	6.0	6.0	6.5	6.5				
Max Green Setting (Gmax), s	21.0	48.0	16.5	49.5	21.0	48.0	20.5	45.5				
Max Q Clear Time (g_c+I1), s	12.0	44.7	8.6	34.6	23.0	36.9	19.0	43.1				
Green Ext Time (p_c), s	0.2	2.6	0.1	3.8	0.0	6.3	0.1	1.1				
Intersection Summary												
HCM 6th Ctrl Delay				62.9								
HCM 6th LOS				E								

Timings

109: SR 7 & Atlantic Boulevard

Lane Group	EBL	EBT	EBR	WBL	WBT	NBL	NBT	NBR	SBL	SBT
Lane Configurations										
Traffic Volume (vph)	324	937	249	616	1485	206	1210	442	122	1261
Future Volume (vph)	324	937	249	616	1485	206	1210	442	122	1261
Turn Type	Prot	NA	Perm	Prot	NA	Prot	NA	Perm	Prot	NA
Protected Phases	7	4		3	8	5	2		1	6
Permitted Phases			4					2		
Detector Phase	7	4	4	3	8	5	2	2	1	6
Switch Phase										
Minimum Initial (s)	4.0	6.0	6.0	4.0	6.0	5.0	8.0	8.0	5.0	8.0
Minimum Split (s)	11.0	42.0	42.0	11.0	59.0	12.0	50.0	50.0	12.0	50.0
Total Split (s)	22.0	42.0	42.0	39.0	59.0	24.0	55.0	55.0	24.0	55.0
Total Split (%)	13.8%	26.3%	26.3%	24.4%	36.9%	15.0%	34.4%	34.4%	15.0%	34.4%
Yellow Time (s)	5.0	5.0	5.0	5.0	5.0	5.0	5.0	5.0	5.0	5.0
All-Red Time (s)	2.0	2.0	2.0	2.0	2.0	2.0	2.0	2.0	2.0	2.0
Lost Time Adjust (s)	0.0	0.0	0.0	0.0	0.0	0.0	0.0	0.0	0.0	0.0
Total Lost Time (s)	7.0	7.0	7.0	7.0	7.0	7.0	7.0	7.0	7.0	7.0
Lead/Lag	Lead	Lag	Lag	Lead	Lag	Lead	Lag	Lag	Lead	Lag
Lead-Lag Optimize?	Yes	Yes	Yes	Yes	Yes	Yes	Yes	Yes	Yes	Yes
Recall Mode	None	None	None	None	None	None	C-Max	C-Max	None	C-Max
Act Effct Green (s)	15.0	35.8	35.8	31.2	52.0	17.0	50.7	50.7	14.3	48.0
Actuated g/C Ratio	0.09	0.22	0.22	0.20	0.32	0.11	0.32	0.32	0.09	0.30
v/c Ratio	1.04	0.85	0.50	0.95	1.01	1.13	0.77	0.61	0.80	1.00
Control Delay	121.1	80.9	30.6	87.3	77.4	165.2	53.9	13.5	91.7	85.4
Queue Delay	0.0	0.0	0.0	0.0	0.0	0.0	0.0	0.0	0.0	0.0
Total Delay	121.1	80.9	30.6	87.3	77.4	165.2	53.9	13.5	91.7	85.4
LOS	F	F	C	F	E	F	D	B	F	F
Approach Delay		81.2			80.2		56.6			85.9
Approach LOS		F			F		E			F

Intersection Summary

Cycle Length: 160
 Actuated Cycle Length: 160
 Offset: 114 (71%), Referenced to phase 2:NBT and 6:SBT, Start of Yellow
 Natural Cycle: 145
 Control Type: Actuated-Coordinated
 Maximum v/c Ratio: 1.13
 Intersection Signal Delay: 75.5
 Intersection LOS: E
 Intersection Capacity Utilization 111.2%
 ICU Level of Service H
 Analysis Period (min) 15

Splits and Phases: 109: SR 7 & Atlantic Boulevard

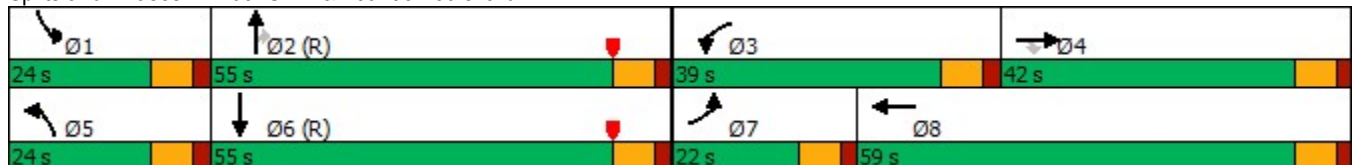

Queues

109: SR 7 & Atlantic Boulevard

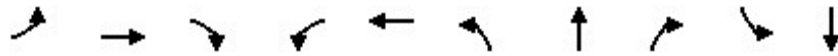

Lane Group	EBL	EBT	EBR	WBL	WBT	NBL	NBT	NBR	SBL	SBT
Lane Group Flow (vph)	334	966	257	635	1654	212	1247	456	126	1501
v/c Ratio	1.04	0.85	0.50	0.95	1.01	1.13	0.77	0.61	0.80	1.00
Control Delay	121.1	80.9	30.6	87.3	77.4	165.2	53.9	13.5	91.7	85.4
Queue Delay	0.0	0.0	0.0	0.0	0.0	0.0	0.0	0.0	0.0	0.0
Total Delay	121.1	80.9	30.6	87.3	77.4	165.2	53.9	13.5	91.7	85.4
Queue Length 50th (ft)	~198	304	85	340	~647	~256	438	71	136	456
Queue Length 95th (ft)	m#283	366	m133	#453	#757	#431	506	201	#221	#671
Internal Link Dist (ft)		5200			1156		610			2153
Turn Bay Length (ft)	275		350	520		400		260	400	
Base Capacity (vph)	321	1137	513	686	1637	188	1610	742	188	1505
Starvation Cap Reductn	0	0	0	0	0	0	0	0	0	0
Spillback Cap Reductn	0	0	0	0	0	0	0	0	0	0
Storage Cap Reductn	0	0	0	0	0	0	0	0	0	0
Reduced v/c Ratio	1.04	0.85	0.50	0.93	1.01	1.13	0.77	0.61	0.67	1.00

Intersection Summary

~ Volume exceeds capacity, queue is theoretically infinite.

Queue shown is maximum after two cycles.



































95th percentile volume exceeds capacity, queue may be longer.

Queue shown is maximum after two cycles.

m Volume for 95th percentile queue is metered by upstream signal.

HCM 6th Signalized Intersection Summary

109: SR 7 & Atlantic Boulevard

												
Movement	EBL	EBT	EBR	WBL	WBT	WBR	NBL	NBT	NBR	SBL	SBT	SBR
Lane Configurations	  	  		  	  				  		  	 
Traffic Volume (veh/h)	324	937	249	616	1485	119	206	1210	442	122	1261	195
Future Volume (veh/h)	324	937	249	616	1485	119	206	1210	442	122	1261	195
Initial Q (Qb), veh	0	0	0	0	0	0	0	0	0	0	0	0
Ped-Bike Adj(A_pbT)	1.00		0.99	1.00		0.99	1.00		0.99	1.00		0.99
Parking Bus, Adj	1.00	1.00	1.00	1.00	1.00	1.00	1.00	1.00	1.00	1.00	1.00	1.00
Work Zone On Approach		No			No			No			No	
Adj Sat Flow, veh/h/ln	1870	1870	1870	1870	1870	1870	1870	1870	1870	1870	1870	1870
Adj Flow Rate, veh/h	334	966	257	635	1531	123	212	1247	456	126	1300	201
Peak Hour Factor	0.97	0.97	0.97	0.97	0.97	0.97	0.97	0.97	0.97	0.97	0.97	0.97
Percent Heavy Veh, %	2	2	2	2	2	2	2	2	2	2	2	2
Cap, veh/h	324	1144	352	673	1565	126	189	1656	511	146	1337	207
Arrive On Green	0.09	0.22	0.22	0.19	0.32	0.32	0.14	0.43	0.43	0.11	0.40	0.40
Sat Flow, veh/h	3456	5106	1572	3456	4816	387	1781	5106	1576	1781	4456	689
Grp Volume(v), veh/h	334	966	257	635	1082	572	212	1247	456	126	993	508
Grp Sat Flow(s),veh/h/ln	1728	1702	1572	1728	1702	1798	1781	1702	1576	1781	1702	1741
Q Serve(g_s), s	15.0	29.0	24.3	29.0	50.3	50.4	17.0	32.9	42.8	11.1	45.8	45.8
Cycle Q Clear(g_c), s	15.0	29.0	24.3	29.0	50.3	50.4	17.0	32.9	42.8	11.1	45.8	45.8
Prop In Lane	1.00		1.00	1.00		0.22	1.00		1.00	1.00		0.40
Lane Grp Cap(c), veh/h	324	1144	352	673	1106	584	189	1656	511	146	1021	522
V/C Ratio(X)	1.03	0.84	0.73	0.94	0.98	0.98	1.12	0.75	0.89	0.86	0.97	0.97
Avail Cap(c_a), veh/h	324	1144	352	691	1106	584	189	1656	511	189	1021	522
HCM Platoon Ratio	1.00	1.00	1.00	1.00	1.00	1.00	1.33	1.33	1.33	1.33	1.33	1.33
Upstream Filter(I)	0.55	0.55	0.55	1.00	1.00	1.00	1.00	1.00	1.00	0.75	0.75	0.75
Uniform Delay (d), s/veh	72.5	59.4	57.6	63.6	53.4	53.5	68.7	40.1	42.9	70.4	47.4	47.4
Incr Delay (d2), s/veh	45.3	3.3	4.0	20.9	21.8	31.7	101.4	3.2	20.5	17.5	18.6	28.0
Initial Q Delay(d3),s/veh	0.0	0.0	0.0	0.0	0.0	0.0	0.0	0.0	0.0	0.0	0.0	0.0
%ile BackOfQ(50%),veh/ln	8.7	12.9	10.1	14.7	24.8	27.9	12.9	13.7	18.8	5.7	21.2	23.0
Unsig. Movement Delay, s/veh												
LnGrp Delay(d),s/veh	117.8	62.7	61.6	84.4	75.2	85.1	170.1	43.3	63.4	87.9	66.1	75.4
LnGrp LOS	F	E	E	F	E	F	F	D	E	F	E	E
Approach Vol, veh/h		1557			2289			1915			1627	
Approach Delay, s/veh		74.3			80.3			62.1			70.7	
Approach LOS		E			F			E			E	
Timer - Assigned Phs	1	2	3	4	5	6	7	8				
Phs Duration (G+Y+Rc), s	20.1	58.9	38.2	42.8	24.0	55.0	22.0	59.0				
Change Period (Y+Rc), s	7.0	7.0	7.0	7.0	7.0	7.0	7.0	7.0				
Max Green Setting (Gmax), s	17.0	48.0	32.0	35.0	17.0	48.0	15.0	52.0				
Max Q Clear Time (g_c+I1), s	13.1	44.8	31.0	31.0	19.0	47.8	17.0	52.4				
Green Ext Time (p_c), s	0.0	2.6	0.2	2.3	0.0	0.1	0.0	0.0				
Intersection Summary												
HCM 6th Ctrl Delay				72.2								
HCM 6th LOS				E								
Notes												
User approved pedestrian interval to be less than phase max green.												

Timings

110: Southgate Boulevard & Rock Island Road

Lane Group	EBL	EBT	EBR	WBL	WBT	NBL	NBT	NBR	SBL	SBT	SBR	
Lane Configurations												
Traffic Volume (vph)	350	413	162	100	523	196	859	99	167	968	498	
Future Volume (vph)	350	413	162	100	523	196	859	99	167	968	498	
Turn Type	Prot	NA	Perm	Prot	NA	pm+pt	NA	Perm	pm+pt	NA	Perm	
Protected Phases	7	4		3	8	5	2		1	6		
Permitted Phases			4			2		2	6		6	
Detector Phase	7	4	4	3	8	5	2	2	1	6	6	
Switch Phase												
Minimum Initial (s)	5.0	6.0	6.0	5.0	6.0	4.0	12.0	12.0	4.0	12.0	12.0	
Minimum Split (s)	11.5	36.5	36.5	11.5	47.5	10.5	44.5	44.5	10.5	44.5	44.5	
Total Split (s)	26.0	54.0	54.0	21.0	49.0	20.0	65.0	65.0	20.0	65.0	65.0	
Total Split (%)	16.3%	33.8%	33.8%	13.1%	30.6%	12.5%	40.6%	40.6%	12.5%	40.6%	40.6%	
Yellow Time (s)	4.5	4.5	4.5	4.5	4.5	4.5	4.5	4.5	4.5	4.5	4.5	
All-Red Time (s)	2.0	2.0	2.0	2.0	2.0	2.0	2.0	2.0	2.0	2.0	2.0	
Lost Time Adjust (s)	0.0	0.0	0.0	0.0	0.0	0.0	0.0	0.0	0.0	0.0	0.0	
Total Lost Time (s)	6.5	6.5	6.5	6.5	6.5	6.5	6.5	6.5	6.5	6.5	6.5	
Lead/Lag	Lead	Lag	Lag	Lead	Lag	Lead	Lag	Lag	Lead	Lag	Lag	
Lead-Lag Optimize?	Yes	Yes	Yes	Yes	Yes	Yes	Yes	Yes	Yes	Yes	Yes	
Recall Mode	None	None	None	None	None	None	C-Max	C-Max	None	C-Max	C-Max	
Act Effct Green (s)	18.9	45.0	45.0	12.3	38.4	79.3	65.2	65.2	74.1	62.6	62.6	
Actuated g/C Ratio	0.12	0.28	0.28	0.08	0.24	0.50	0.41	0.41	0.46	0.39	0.39	
v/c Ratio	0.90	0.43	0.31	0.76	0.90	0.82	0.62	0.15	0.65	0.73	0.66	
Control Delay	94.9	48.3	8.5	105.2	70.0	52.0	41.2	4.9	35.5	45.6	25.1	
Queue Delay	0.0	0.0	0.0	0.0	0.0	0.0	0.0	0.0	0.0	0.0	0.0	
Total Delay	94.9	48.3	8.5	105.2	70.0	52.0	41.2	4.9	35.5	45.6	25.1	
LOS	F	D	A	F	E	D	D	A	D	D	C	
Approach Delay		59.0			74.3		39.9			38.3		
Approach LOS		E			E		D			D		

Intersection Summary

Cycle Length: 160

Actuated Cycle Length: 160

Offset: 80 (50%), Referenced to phase 2:NBTL and 6:SBTL, Start of Yellow

Natural Cycle: 125

Control Type: Actuated-Coordinated

Maximum v/c Ratio: 0.90

Intersection Signal Delay: 49.4

Intersection LOS: D

Intersection Capacity Utilization 90.1%

ICU Level of Service E

Analysis Period (min) 15

Splits and Phases: 110: Southgate Boulevard & Rock Island Road

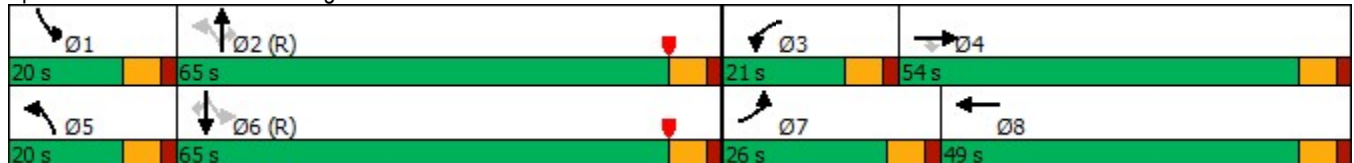

Queues

110: Southgate Boulevard & Rock Island Road



Lane Group	EBL	EBT	EBR	WBL	WBT	NBL	NBT	NBR	SBL	SBT	SBR
Lane Group Flow (vph)	365	430	169	104	751	204	895	103	174	1008	519
v/c Ratio	0.90	0.43	0.31	0.76	0.90	0.82	0.62	0.15	0.65	0.73	0.66
Control Delay	94.9	48.3	8.5	105.2	70.0	52.0	41.2	4.9	35.5	45.6	25.1
Queue Delay	0.0	0.0	0.0	0.0	0.0	0.0	0.0	0.0	0.0	0.0	0.0
Total Delay	94.9	48.3	8.5	105.2	70.0	52.0	41.2	4.9	35.5	45.6	25.1
Queue Length 50th (ft)	196	194	8	108	385	116	400	0	103	344	176
Queue Length 95th (ft)	#283	244	67	#186	457	#270	496	36	m121	m396	m199
Internal Link Dist (ft)		387			374		435			2618	
Turn Bay Length (ft)	310		140	220		230			170		170
Base Capacity (vph)	418	1050	574	160	925	253	1440	702	290	1384	783
Starvation Cap Reductn	0	0	0	0	0	0	0	0	0	0	0
Spillback Cap Reductn	0	0	0	0	0	0	0	0	0	0	0
Storage Cap Reductn	0	0	0	0	0	0	0	0	0	0	0
Reduced v/c Ratio	0.87	0.41	0.29	0.65	0.81	0.81	0.62	0.15	0.60	0.73	0.66

Intersection Summary





























95th percentile volume exceeds capacity, queue may be longer.

Queue shown is maximum after two cycles.

m Volume for 95th percentile queue is metered by upstream signal.

HCM 6th Signalized Intersection Summary

110: Southgate Boulevard & Rock Island Road

												
Movement	EBL	EBT	EBR	WBL	WBT	WBR	NBL	NBT	NBR	SBL	SBT	SBR
Lane Configurations	 	 			 			 			 	
Traffic Volume (veh/h)	350	413	162	100	523	198	196	859	99	167	968	498
Future Volume (veh/h)	350	413	162	100	523	198	196	859	99	167	968	498
Initial Q (Qb), veh	0	0	0	0	0	0	0	0	0	0	0	0
Ped-Bike Adj(A_pbT)	1.00		0.99	1.00		1.00	1.00		1.00	1.00		1.00
Parking Bus, Adj	1.00	1.00	1.00	1.00	1.00	1.00	1.00	1.00	1.00	1.00	1.00	1.00
Work Zone On Approach		No			No			No			No	
Adj Sat Flow, veh/h/ln	1870	1870	1870	1870	1870	1870	1870	1870	1870	1870	1870	1870
Adj Flow Rate, veh/h	365	430	169	104	545	206	204	895	0	174	1008	519
Peak Hour Factor	0.96	0.96	0.96	0.96	0.96	0.96	0.96	0.96	0.96	0.96	0.96	0.96
Percent Heavy Veh, %	2	2	2	2	2	2	2	2	2	2	2	2
Cap, veh/h	405	1007	443	124	595	224	254	1473		322	1437	641
Arrive On Green	0.12	0.28	0.28	0.07	0.24	0.24	0.11	0.55	0.00	0.09	0.54	0.54
Sat Flow, veh/h	3456	3554	1564	1781	2525	951	1781	3554	1585	1781	3554	1585
Grp Volume(v), veh/h	365	430	169	104	383	368	204	895	0	174	1008	519
Grp Sat Flow(s),veh/h/ln	1728	1777	1564	1781	1777	1699	1781	1777	1585	1781	1777	1585
Q Serve(g_s), s	16.7	15.8	13.9	9.2	33.6	33.8	10.8	27.2	0.0	9.2	33.7	42.9
Cycle Q Clear(g_c), s	16.7	15.8	13.9	9.2	33.6	33.8	10.8	27.2	0.0	9.2	33.7	42.9
Prop In Lane	1.00		1.00	1.00		0.56	1.00		1.00	1.00		1.00
Lane Grp Cap(c), veh/h	405	1007	443	124	419	401	254	1473		322	1437	641
V/C Ratio(X)	0.90	0.43	0.38	0.84	0.91	0.92	0.80	0.61		0.54	0.70	0.81
Avail Cap(c_a), veh/h	421	1055	464	161	472	451	261	1473		347	1437	641
HCM Platoon Ratio	1.00	1.00	1.00	1.00	1.00	1.00	1.33	1.33	1.33	1.33	1.33	1.33
Upstream Filter(I)	1.00	1.00	1.00	1.00	1.00	1.00	1.00	1.00	0.00	0.13	0.13	0.13
Uniform Delay (d), s/veh	69.7	46.8	46.1	73.5	59.6	59.6	31.0	27.1	0.0	26.6	29.8	31.9
Incr Delay (d2), s/veh	20.9	0.1	0.2	20.3	19.8	21.2	14.8	1.9	0.0	0.1	0.4	1.5
Initial Q Delay(d3),s/veh	0.0	0.0	0.0	0.0	0.0	0.0	0.0	0.0	0.0	0.0	0.0	0.0
%ile BackOfQ(50%),veh/ln	8.6	7.1	5.5	4.9	17.5	17.0	5.5	11.2	0.0	3.8	13.6	15.6
Unsig. Movement Delay, s/veh												
LnGrp Delay(d),s/veh	90.6	46.9	46.3	93.9	79.4	80.9	45.8	29.0	0.0	26.7	30.2	33.5
LnGrp LOS	F	D	D	F	E	F	D	C		C	C	C
Approach Vol, veh/h		964			855			1099			1701	
Approach Delay, s/veh		63.3			81.8			32.1			30.8	
Approach LOS		E			F			C			C	
Timer - Assigned Phs	1	2	3	4	5	6	7	8				
Phs Duration (G+Y+Rc), s	17.7	72.8	17.6	51.8	19.3	71.2	25.2	44.2				
Change Period (Y+Rc), s	6.5	6.5	6.5	6.5	6.5	6.5	6.5	6.5				
Max Green Setting (Gmax), s	13.5	58.5	14.5	47.5	13.5	58.5	19.5	42.5				
Max Q Clear Time (g_c+I1), s	11.2	29.2	11.2	17.8	12.8	44.9	18.7	35.8				
Green Ext Time (p_c), s	0.0	7.3	0.0	2.3	0.0	7.6	0.1	1.9				
Intersection Summary												
HCM 6th Ctrl Delay			47.3									
HCM 6th LOS			D									
Notes												
Unsignalized Delay for [NBR] is excluded from calculations of the approach delay and intersection delay.												

Timings

111: NW 66 Avenue & Atlantic Boulevard

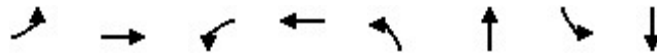

Lane Group	EBL	EBT	WBL	WBT	NBL	NBT	SBL	SBT
Lane Configurations	↶	↶↶↶	↶	↶↶↶	↶	↶	↶	↶
Traffic Volume (vph)	125	1206	59	1916	64	15	128	27
Future Volume (vph)	125	1206	59	1916	64	15	128	27
Turn Type	pm+pt	NA	pm+pt	NA	Perm	NA	Perm	NA
Protected Phases	1	6	5	2		4		8
Permitted Phases	6		2		4		8	
Detector Phase	1	6	5	2	4	4	8	8
Switch Phase								
Minimum Initial (s)	4.0	10.0	4.0	10.0	6.0	6.0	6.0	6.0
Minimum Split (s)	12.0	50.0	12.0	50.0	45.0	45.0	45.0	45.0
Total Split (s)	25.0	87.0	25.0	87.0	48.0	48.0	48.0	48.0
Total Split (%)	15.6%	54.4%	15.6%	54.4%	30.0%	30.0%	30.0%	30.0%
Yellow Time (s)	4.0	4.0	4.0	4.0	4.0	4.0	4.0	4.0
All-Red Time (s)	2.0	2.0	2.0	2.0	2.0	2.0	2.0	2.0
Lost Time Adjust (s)	0.0	0.0	0.0	0.0	0.0	0.0	0.0	0.0
Total Lost Time (s)	6.0	6.0	6.0	6.0	6.0	6.0	6.0	6.0
Lead/Lag	Lead	Lag	Lead	Lag				
Lead-Lag Optimize?	Yes	Yes	Yes	Yes				
Recall Mode	None	C-Max	None	C-Max	None	None	None	None
Act Effct Green (s)	103.3	96.2	97.6	91.7	42.0	42.0	42.0	42.0
Actuated g/C Ratio	0.65	0.60	0.61	0.57	0.26	0.26	0.26	0.26
v/c Ratio	0.95	0.43	0.25	0.74	0.24	0.13	0.38	0.30
Control Delay	102.0	18.1	12.3	27.5	49.3	17.9	52.3	12.6
Queue Delay	0.0	0.0	0.0	0.0	0.0	0.0	0.0	0.0
Total Delay	102.0	18.1	12.3	27.5	49.3	17.9	52.3	12.6
LOS	F	B	B	C	D	B	D	B
Approach Delay		25.6		27.1		34.6		30.7
Approach LOS		C		C		C		C

Intersection Summary

Cycle Length: 160
 Actuated Cycle Length: 160
 Offset: 85 (53%), Referenced to phase 2:WBTL and 6:EBTL, Start of Yellow
 Natural Cycle: 110
 Control Type: Actuated-Coordinated
 Maximum v/c Ratio: 0.95
 Intersection Signal Delay: 27.1
 Intersection Capacity Utilization 85.0%
 Analysis Period (min) 15

Intersection LOS: C
 ICU Level of Service E

Splits and Phases: 111: NW 66 Avenue & Atlantic Boulevard

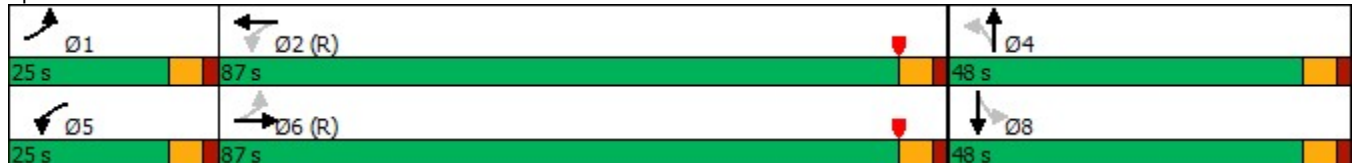

Queues

111: NW 66 Avenue & Atlantic Boulevard



Lane Group	EBL	EBT	WBL	WBT	NBL	NBT	SBL	SBT
Lane Group Flow (vph)	130	1314	61	2149	67	59	133	159
v/c Ratio	0.95	0.43	0.25	0.74	0.24	0.13	0.38	0.30
Control Delay	102.0	18.1	12.3	27.5	49.3	17.9	52.3	12.6
Queue Delay	0.0	0.0	0.0	0.0	0.0	0.0	0.0	0.0
Total Delay	102.0	18.1	12.3	27.5	49.3	17.9	52.3	12.6
Queue Length 50th (ft)	87	269	21	590	56	13	115	22
Queue Length 95th (ft)	#199	312	39	673	103	52	184	84
Internal Link Dist (ft)		2560		1156		610		2153
Turn Bay Length (ft)	200		200		190		190	
Base Capacity (vph)	252	3037	378	2887	279	460	348	525
Starvation Cap Reductn	0	0	0	0	0	0	0	0
Spillback Cap Reductn	0	0	0	0	0	0	0	0
Storage Cap Reductn	0	0	0	0	0	0	0	0
Reduced v/c Ratio	0.52	0.43	0.16	0.74	0.24	0.13	0.38	0.30

Intersection Summary

95th percentile volume exceeds capacity, queue may be longer.
 Queue shown is maximum after two cycles.

HCM 6th Signalized Intersection Summary

111: NW 66 Avenue & Atlantic Boulevard

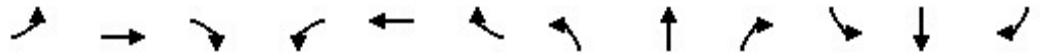

Movement	EBL	EBT	EBR	WBL	WBT	WBR	NBL	NBT	NBR	SBL	SBT	SBR
Lane Configurations	↖	↑↑↑		↖	↑↑↑		↖	↑		↖	↑	
Traffic Volume (veh/h)	125	1206	56	59	1916	147	64	15	41	128	27	126
Future Volume (veh/h)	125	1206	56	59	1916	147	64	15	41	128	27	126
Initial Q (Qb), veh	0	0	0	0	0	0	0	0	0	0	0	0
Ped-Bike Adj(A_pbT)	1.00		1.00	1.00		1.00	0.99		0.99	0.99		0.99
Parking Bus, Adj	1.00	1.00	1.00	1.00	1.00	1.00	1.00	1.00	1.00	1.00	1.00	1.00
Work Zone On Approach		No			No			No			No	
Adj Sat Flow, veh/h/ln	1870	1870	1870	1870	1870	1870	1870	1870	1870	1870	1870	1870
Adj Flow Rate, veh/h	130	1256	58	61	1996	153	67	16	43	133	28	131
Peak Hour Factor	0.96	0.96	0.96	0.96	0.96	0.96	0.96	0.96	0.96	0.96	0.96	0.96
Percent Heavy Veh, %	2	2	2	2	2	2	2	2	2	2	2	2
Cap, veh/h	193	3483	161	335	3313	253	142	75	200	229	48	223
Arrive On Green	0.03	0.70	0.70	0.02	0.68	0.68	0.22	0.22	0.22	0.22	0.22	0.22
Sat Flow, veh/h	1781	5002	231	1781	4839	369	1218	444	1194	1330	284	1328
Grp Volume(v), veh/h	130	855	459	61	1401	748	67	0	59	133	0	159
Grp Sat Flow(s),veh/h/ln	1781	1702	1829	1781	1702	1804	1218	0	1638	1330	0	1612
Q Serve(g_s), s	3.5	16.3	16.3	1.7	35.3	35.8	8.5	0.0	4.7	15.1	0.0	14.1
Cycle Q Clear(g_c), s	3.5	16.3	16.3	1.7	35.3	35.8	22.6	0.0	4.7	19.8	0.0	14.1
Prop In Lane	1.00		0.13	1.00		0.20	1.00		0.73	1.00		0.82
Lane Grp Cap(c), veh/h	193	2370	1273	335	2330	1235	142	0	275	229	0	271
V/C Ratio(X)	0.67	0.36	0.36	0.18	0.60	0.61	0.47	0.00	0.21	0.58	0.00	0.59
Avail Cap(c_a), veh/h	342	2370	1273	505	2330	1235	257	0	430	355	0	423
HCM Platoon Ratio	1.00	1.00	1.00	1.00	1.00	1.00	1.33	1.33	1.33	1.33	1.33	1.33
Upstream Filter(l)	1.00	1.00	1.00	1.00	1.00	1.00	1.00	0.00	1.00	1.00	0.00	1.00
Uniform Delay (d), s/veh	20.0	9.9	9.9	7.8	13.5	13.6	67.3	0.0	53.5	61.6	0.0	57.2
Incr Delay (d2), s/veh	1.5	0.4	0.8	0.1	1.2	2.2	0.9	0.0	0.1	0.9	0.0	0.8
Initial Q Delay(d3),s/veh	0.0	0.0	0.0	0.0	0.0	0.0	0.0	0.0	0.0	0.0	0.0	0.0
%ile BackOfQ(50%),veh/ln	3.1	6.2	6.8	0.6	13.6	15.0	2.6	0.0	2.0	5.0	0.0	5.7
Unsig. Movement Delay, s/veh												
LnGrp Delay(d),s/veh	21.5	10.3	10.7	7.9	14.7	15.8	68.2	0.0	53.7	62.5	0.0	57.9
LnGrp LOS	C	B	B	A	B	B	E	A	D	E	A	E
Approach Vol, veh/h		1444			2210			126				292
Approach Delay, s/veh		11.4			14.9			61.4				60.0
Approach LOS		B			B			E				E
Timer - Assigned Phs	1	2		4	5	6		8				
Phs Duration (G+Y+Rc), s	11.6	115.5		32.9	9.7	117.4		32.9				
Change Period (Y+Rc), s	6.0	6.0		6.0	6.0	6.0		6.0				
Max Green Setting (Gmax), s	19.0	81.0		42.0	19.0	81.0		42.0				
Max Q Clear Time (g_c+I1), s	5.5	37.8		24.6	3.7	18.3		21.8				
Green Ext Time (p_c), s	0.1	26.4		0.3	0.0	13.1		0.8				

Intersection Summary

HCM 6th Ctrl Delay	18.3
HCM 6th LOS	B

Notes

User approved pedestrian interval to be less than phase max green.

HCM 6th AWSC
 112: NW 66 Avenue & Margate Boulevard

Intersection	
Intersection Delay, s/veh	13
Intersection LOS	B

Movement	EBL	EBT	EBR	WBL	WBT	WBR	NBL	NBT	NBR	SBL	SBT	SBR
Lane Configurations												
Traffic Vol, veh/h	47	191	54	41	379	26	61	76	47	12	73	62
Future Vol, veh/h	47	191	54	41	379	26	61	76	47	12	73	62
Peak Hour Factor	0.96	0.96	0.96	0.96	0.96	0.96	0.96	0.96	0.96	0.96	0.96	0.96
Heavy Vehicles, %	2	2	2	2	2	2	2	2	2	2	2	2
Mvmt Flow	49	199	56	43	395	27	64	79	49	13	76	65
Number of Lanes	1	2	0	0	2	0	0	1	0	0	1	0

Approach	EB	WB	NB	SB
Opposing Approach	WB	EB	SB	NB
Opposing Lanes	2	3	1	1
Conflicting Approach Left	SB	NB	EB	WB
Conflicting Lanes Left	1	1	3	2
Conflicting Approach Right	NB	SB	WB	EB
Conflicting Lanes Right	1	1	2	3
HCM Control Delay	10.9	14.4	13.7	12.3
HCM LOS	B	B	B	B

Lane	NBLn1	EBLn1	EBLn2	EBLn3	WBLn1	WBLn2	SBLn1
Vol Left, %	33%	100%	0%	0%	18%	0%	8%
Vol Thru, %	41%	0%	100%	54%	82%	88%	50%
Vol Right, %	26%	0%	0%	46%	0%	12%	42%
Sign Control	Stop	Stop	Stop	Stop	Stop	Stop	Stop
Traffic Vol by Lane	184	47	127	118	231	216	147
LT Vol	61	47	0	0	41	0	12
Through Vol	76	0	127	64	190	190	73
RT Vol	47	0	0	54	0	26	62
Lane Flow Rate	192	49	133	123	240	224	153
Geometry Grp	7	7	7	7	8	8	7
Degree of Util (X)	0.368	0.095	0.239	0.21	0.449	0.408	0.288
Departure Headway (Hd)	6.911	7.001	6.491	6.163	6.726	6.549	6.771
Convergence, Y/N	Yes	Yes	Yes	Yes	Yes	Yes	Yes
Cap	518	509	549	579	533	545	527
Service Time	4.699	4.787	4.277	3.949	4.511	4.334	4.563
HCM Lane V/C Ratio	0.371	0.096	0.242	0.212	0.45	0.411	0.29
HCM Control Delay	13.7	10.5	11.3	10.6	14.9	13.8	12.3
HCM Lane LOS	B	B	B	B	B	B	B
HCM 95th-tile Q	1.7	0.3	0.9	0.8	2.3	2	1.2

Timings

101: Rock Island Road & Royal Palm Boulevard

Lane Group	EBL	EBT	WBL	WBT	NBL	NBT	NBR	SBL	SBT	SBR
Lane Configurations										
Traffic Volume (vph)	137	562	284	970	361	640	257	200	753	180
Future Volume (vph)	137	562	284	970	361	640	257	200	753	180
Turn Type	Prot	NA	Prot	NA	pm+pt	NA	Perm	pm+pt	NA	Perm
Protected Phases	1	6	5	2	7	4		3	8	
Permitted Phases					4		4	8		8
Detector Phase	1	6	5	2	7	4	4	3	8	8
Switch Phase										
Minimum Initial (s)	5.0	10.0	5.0	10.0	4.0	6.0	6.0	4.0	6.0	6.0
Minimum Split (s)	11.5	43.5	11.5	43.5	10.5	43.5	43.5	10.5	39.0	39.0
Total Split (s)	26.0	64.0	26.0	64.0	31.0	45.0	45.0	25.0	39.0	39.0
Total Split (%)	16.3%	40.0%	16.3%	40.0%	19.4%	28.1%	28.1%	15.6%	24.4%	24.4%
Yellow Time (s)	4.5	4.5	4.5	4.5	4.5	4.5	4.5	4.5	4.5	4.5
All-Red Time (s)	2.0	2.0	2.0	2.0	2.0	2.0	2.0	2.0	2.0	2.0
Lost Time Adjust (s)	0.0	0.0	0.0	0.0	0.0	0.0	0.0	0.0	0.0	0.0
Total Lost Time (s)	6.5	6.5	6.5	6.5	6.5	6.5	6.5	6.5	6.5	6.5
Lead/Lag	Lead	Lag	Lead	Lag	Lead	Lag	Lag	Lead	Lag	Lag
Lead-Lag Optimize?	Yes	Yes	Yes	Yes	Yes	Yes	Yes	Yes	Yes	Yes
Recall Mode	None	C-Max	None	C-Max	None	None	None	None	None	None
Act Effct Green (s)	16.0	57.5	19.5	61.0	63.3	40.9	40.9	48.6	32.5	32.5
Actuated g/C Ratio	0.10	0.36	0.12	0.38	0.40	0.26	0.26	0.30	0.20	0.20
v/c Ratio	0.81	0.66	1.38	0.95	1.19	0.74	0.51	0.79	1.09	0.46
Control Delay	101.7	43.6	244.7	62.0	162.1	44.8	12.7	55.9	119.0	26.4
Queue Delay	0.0	0.0	0.0	0.0	0.0	0.0	0.0	0.0	0.0	0.0
Total Delay	101.7	43.6	244.7	62.0	162.1	44.8	12.7	55.9	119.0	26.4
LOS	F	D	F	E	F	D	B	E	F	C
Approach Delay		52.3		96.9		71.9			93.1	
Approach LOS		D		F		E			F	

Intersection Summary

Cycle Length: 160	
Actuated Cycle Length: 160	
Offset: 104 (65%), Referenced to phase 2:WBT and 6:EBT, Start of Yellow	
Natural Cycle: 140	
Control Type: Actuated-Coordinated	
Maximum v/c Ratio: 1.38	
Intersection Signal Delay: 80.9	Intersection LOS: F
Intersection Capacity Utilization 104.3%	ICU Level of Service G
Analysis Period (min) 15	

Splits and Phases: 101: Rock Island Road & Royal Palm Boulevard

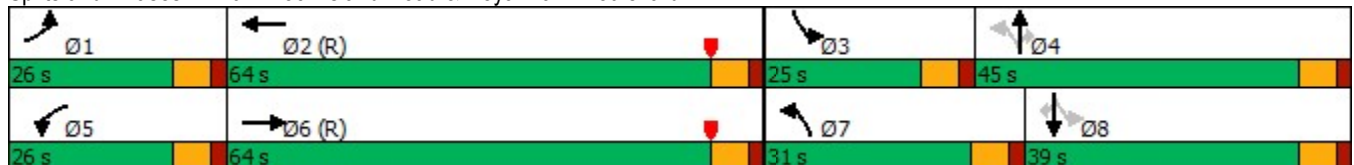

Queues

101: Rock Island Road & Royal Palm Boulevard



Lane Group	EBL	EBT	WBL	WBT	NBL	NBT	NBR	SBL	SBT	SBR
Lane Group Flow (vph)	143	816	296	1251	376	667	268	208	784	188
v/c Ratio	0.81	0.66	1.38	0.95	1.19	0.74	0.51	0.79	1.09	0.46
Control Delay	101.7	43.6	244.7	62.0	162.1	44.8	12.7	55.9	119.0	26.4
Queue Delay	0.0	0.0	0.0	0.0	0.0	0.0	0.0	0.0	0.0	0.0
Total Delay	101.7	43.6	244.7	62.0	162.1	44.8	12.7	55.9	119.0	26.4
Queue Length 50th (ft)	148	358	~408	662	~408	323	47	148	~484	68
Queue Length 95th (ft)	225	434	#605	#850	#633	370	86	217	#618	151
Internal Link Dist (ft)		625		856		3088			735	
Turn Bay Length (ft)	300		200		200		160	140		170
Base Capacity (vph)	215	1244	215	1321	317	904	528	290	718	410
Starvation Cap Reductn	0	0	0	0	0	0	0	0	0	0
Spillback Cap Reductn	0	0	0	0	0	0	0	0	0	0
Storage Cap Reductn	0	0	0	0	0	0	0	0	0	0
Reduced v/c Ratio	0.67	0.66	1.38	0.95	1.19	0.74	0.51	0.72	1.09	0.46

Intersection Summary

~ Volume exceeds capacity, queue is theoretically infinite.

Queue shown is maximum after two cycles.

95th percentile volume exceeds capacity, queue may be longer.

Queue shown is maximum after two cycles.

HCM 6th Signalized Intersection Summary

101: Rock Island Road & Royal Palm Boulevard

Movement	EBL	EBT	EBR	WBL	WBT	WBR	NBL	NBT	NBR	SBL	SBT	SBR
Lane Configurations												
Traffic Volume (veh/h)	137	562	222	284	970	231	361	640	257	200	753	180
Future Volume (veh/h)	137	562	222	284	970	231	361	640	257	200	753	180
Initial Q (Qb), veh	0	0	0	0	0	0	0	0	0	0	0	0
Ped-Bike Adj(A_pbT)	1.00		1.00	1.00		1.00	1.00		1.00	1.00		1.00
Parking Bus, Adj	1.00	1.00	1.00	1.00	1.00	1.00	1.00	1.00	1.00	1.00	1.00	1.00
Work Zone On Approach		No			No			No			No	
Adj Sat Flow, veh/h/ln	1870	1870	1870	1870	1870	1870	1870	1870	1870	1870	1870	1870
Adj Flow Rate, veh/h	143	585	231	296	1010	241	376	667	268	208	784	188
Peak Hour Factor	0.96	0.96	0.96	0.96	0.96	0.96	0.96	0.96	0.96	0.96	0.96	0.96
Percent Heavy Veh, %	2	2	2	2	2	2	2	2	2	2	2	2
Cap, veh/h	163	895	353	217	1110	264	318	895	399	275	722	322
Arrive On Green	0.12	0.48	0.48	0.16	0.52	0.52	0.10	0.17	0.17	0.10	0.20	0.20
Sat Flow, veh/h	1781	2489	981	1781	2848	677	1781	3554	1585	1781	3554	1585
Grp Volume(v), veh/h	143	417	399	296	629	622	376	667	268	208	784	188
Grp Sat Flow(s),veh/h/ln	1781	1777	1694	1781	1777	1748	1781	1777	1585	1781	1777	1585
Q Serve(g_s), s	12.6	28.5	28.6	19.5	51.5	52.1	24.5	28.6	25.4	14.7	32.5	17.2
Cycle Q Clear(g_c), s	12.6	28.5	28.6	19.5	51.5	52.1	24.5	28.6	25.4	14.7	32.5	17.2
Prop In Lane	1.00		0.58	1.00		0.39	1.00		1.00	1.00		1.00
Lane Grp Cap(c), veh/h	163	639	609	217	692	681	318	895	399	275	722	322
V/C Ratio(X)	0.88	0.65	0.66	1.36	0.91	0.91	1.18	0.74	0.67	0.76	1.09	0.58
Avail Cap(c_a), veh/h	217	639	609	217	692	681	318	895	399	295	722	322
HCM Platoon Ratio	1.33	1.33	1.33	1.33	1.33	1.33	0.67	0.67	0.67	1.00	1.00	1.00
Upstream Filter(I)	1.00	1.00	1.00	1.00	1.00	1.00	0.90	0.90	0.90	1.00	1.00	1.00
Uniform Delay (d), s/veh	69.4	34.2	34.2	67.0	35.9	36.1	55.8	61.6	60.3	45.5	63.8	57.6
Incr Delay (d2), s/veh	21.1	5.1	5.4	190.3	17.9	18.8	107.7	2.7	3.2	8.6	59.3	1.8
Initial Q Delay(d3),s/veh	0.0	0.0	0.0	0.0	0.0	0.0	0.0	0.0	0.0	0.0	0.0	0.0
%ile BackOfQ(50%),veh/ln	6.6	12.7	12.1	20.1	24.3	24.3	19.5	13.7	10.9	7.2	20.7	7.1
Unsig. Movement Delay, s/veh												
LnGrp Delay(d),s/veh	90.5	39.3	39.7	257.3	53.9	54.8	163.4	64.3	63.5	54.2	123.1	59.5
LnGrp LOS	F	D	D	F	D	D	F	E	E	D	F	E
Approach Vol, veh/h		959			1547			1311			1180	
Approach Delay, s/veh		47.1			93.2			92.6			100.8	
Approach LOS		D			F			F			F	
Timer - Assigned Phs	1	2	3	4	5	6	7	8				
Phs Duration (G+Y+Rc), s	21.2	68.8	23.2	46.8	26.0	64.0	31.0	39.0				
Change Period (Y+Rc), s	6.5	6.5	6.5	6.5	6.5	6.5	6.5	6.5				
Max Green Setting (Gmax), s	19.5	57.5	18.5	38.5	19.5	57.5	24.5	32.5				
Max Q Clear Time (g_c+I1), s	14.6	54.1	16.7	30.6	21.5	30.6	26.5	34.5				
Green Ext Time (p_c), s	0.0	2.4	0.0	2.4	0.0	5.9	0.0	0.0				
Intersection Summary												
HCM 6th Ctrl Delay				86.0								
HCM 6th LOS				F								
Notes												
User approved pedestrian interval to be less than phase max green.												

HCM 6th TWSC
 102: NW 76 Avenue & Margate Boulevard

Intersection						
Int Delay, s/veh	5.7					
Movement	EBT	EBR	WBL	WBT	NBL	NBR
Lane Configurations	↑↑		↖	↑↑	↘	
Traffic Vol, veh/h	64	88	122	114	151	56
Future Vol, veh/h	64	88	122	114	151	56
Conflicting Peds, #/hr	0	0	0	0	1	2
Sign Control	Free	Free	Free	Free	Stop	Stop
RT Channelized	-	None	-	None	-	None
Storage Length	-	-	100	-	0	-
Veh in Median Storage, #	0	-	-	0	1	-
Grade, %	0	-	-	0	0	-
Peak Hour Factor	87	87	87	87	87	87
Heavy Vehicles, %	2	2	2	2	2	2
Mvmt Flow	74	101	140	131	174	64

Major/Minor	Major1	Major2	Minor1		
Conflicting Flow All	0	0	175	0	472 90
Stage 1	-	-	-	-	125 -
Stage 2	-	-	-	-	347 -
Critical Hdwy	-	-	4.14	-	5 4.5
Critical Hdwy Stg 1	-	-	-	-	5 -
Critical Hdwy Stg 2	-	-	-	-	5 -
Follow-up Hdwy	-	-	2.22	-	3 3
Pot Cap-1 Maneuver	-	-	1399	-	754 1113
Stage 1	-	-	-	-	1062 -
Stage 2	-	-	-	-	853 -
Platoon blocked, %	-	-	-	-	-
Mov Cap-1 Maneuver	-	-	1399	-	678 1111
Mov Cap-2 Maneuver	-	-	-	-	685 -
Stage 1	-	-	-	-	1062 -
Stage 2	-	-	-	-	767 -

Approach	EB	WB	NB
HCM Control Delay, s	0	4.1	11.8
HCM LOS			B

Minor Lane/Major Mvmt	NBLn1	EBT	EBR	WBL	WBT
Capacity (veh/h)	764	-	-	1399	-
HCM Lane V/C Ratio	0.311	-	-	0.1	-
HCM Control Delay (s)	11.8	-	-	7.9	-
HCM Lane LOS	B	-	-	A	-
HCM 95th %tile Q(veh)	1.3	-	-	0.3	-

Timings

103: Rock Island Road & Margate Boulevard

Lane Group	EBL	EBT	WBL	WBT	NBL	NBT	NBR	SBL	SBT	SBR
Lane Configurations										
Traffic Volume (vph)	61	40	172	148	32	924	171	114	920	93
Future Volume (vph)	61	40	172	148	32	924	171	114	920	93
Turn Type	pm+pt	NA	pm+pt	NA	pm+pt	NA	Perm	pm+pt	NA	Perm
Protected Phases	7	4	3	8	5	2		1	6	
Permitted Phases	4		8		2		2	6		6
Detector Phase	7	4	3	8	5	2	2	1	6	6
Switch Phase										
Minimum Initial (s)	4.0	6.0	4.0	6.0	4.0	12.0	12.0	4.0	12.0	12.0
Minimum Split (s)	10.0	37.0	10.0	37.0	10.5	37.5	37.5	10.5	37.5	37.5
Total Split (s)	18.0	40.0	18.0	40.0	26.0	76.0	76.0	26.0	76.0	76.0
Total Split (%)	11.3%	25.0%	11.3%	25.0%	16.3%	47.5%	47.5%	16.3%	47.5%	47.5%
Yellow Time (s)	4.0	4.0	4.0	4.0	4.5	4.5	4.5	4.5	4.5	4.5
All-Red Time (s)	2.0	2.0	2.0	2.0	2.0	2.0	2.0	2.0	2.0	2.0
Lost Time Adjust (s)	0.0	0.0	0.0	0.0	0.0	0.0	0.0	0.0	0.0	0.0
Total Lost Time (s)	6.0	6.0	6.0	6.0	6.5	6.5	6.5	6.5	6.5	6.5
Lead/Lag	Lead	Lag	Lead	Lag	Lead	Lag	Lag	Lead	Lag	Lag
Lead-Lag Optimize?	Yes	Yes	Yes	Yes	Yes	Yes	Yes	Yes	Yes	Yes
Recall Mode	None	None	None	None	None	C-Max	C-Max	None	C-Max	C-Max
Act Effct Green (s)	20.2	11.3	26.1	14.3	109.4	104.5	104.5	115.2	109.0	109.0
Actuated g/C Ratio	0.13	0.07	0.16	0.09	0.68	0.65	0.65	0.72	0.68	0.68
v/c Ratio	0.46	0.26	0.82	0.76	0.09	0.43	0.17	0.33	0.41	0.09
Control Delay	64.2	47.1	88.5	48.4	6.4	11.1	4.9	5.8	7.9	0.5
Queue Delay	0.0	0.0	0.0	0.0	0.0	0.0	0.0	0.0	0.0	0.0
Total Delay	64.2	47.1	88.5	48.4	6.4	11.1	4.9	5.8	7.9	0.5
LOS	E	D	F	D	A	B	A	A	A	A
Approach Delay		55.5		62.9		10.0			7.1	
Approach LOS		E		E		B			A	

Intersection Summary

Cycle Length: 160

Actuated Cycle Length: 160

Offset: 104 (65%), Referenced to phase 2:NBTL and 6:SBTL, Start of Yellow

Natural Cycle: 95

Control Type: Actuated-Coordinated

Maximum v/c Ratio: 0.82

Intersection Signal Delay: 19.7

Intersection LOS: B

Intersection Capacity Utilization 67.2%

ICU Level of Service C

Analysis Period (min) 15

Splits and Phases: 103: Rock Island Road & Margate Boulevard

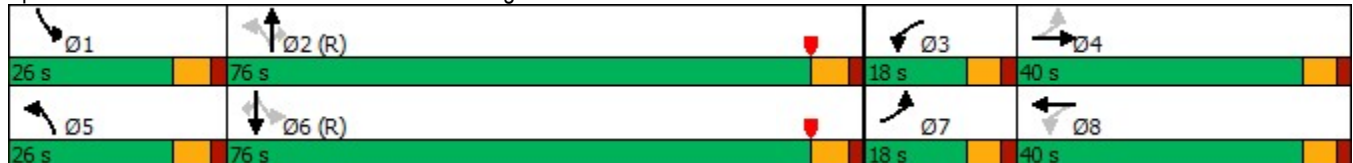

Queues

103: Rock Island Road & Margate Boulevard



Lane Group	EBL	EBT	WBL	WBT	NBL	NBT	NBR	SBL	SBT	SBR
Lane Group Flow (vph)	66	67	185	328	34	994	184	123	989	100
v/c Ratio	0.46	0.26	0.82	0.76	0.09	0.43	0.17	0.33	0.41	0.09
Control Delay	64.2	47.1	88.5	48.4	6.4	11.1	4.9	5.8	7.9	0.5
Queue Delay	0.0	0.0	0.0	0.0	0.0	0.0	0.0	0.0	0.0	0.0
Total Delay	64.2	47.1	88.5	48.4	6.4	11.1	4.9	5.8	7.9	0.5
Queue Length 50th (ft)	60	22	180	94	8	161	19	20	152	1
Queue Length 95th (ft)	101	47	#257	146	m13	m197	m34	m32	m212	m1
Internal Link Dist (ft)		2155		508		3616			3088	
Turn Bay Length (ft)	320		110		180		180	190		160
Base Capacity (vph)	179	730	225	817	511	2311	1073	487	2410	1111
Starvation Cap Reductn	0	0	0	0	0	0	0	0	0	0
Spillback Cap Reductn	0	0	0	0	0	0	0	0	0	0
Storage Cap Reductn	0	0	0	0	0	0	0	0	0	0
Reduced v/c Ratio	0.37	0.09	0.82	0.40	0.07	0.43	0.17	0.25	0.41	0.09

Intersection Summary























95th percentile volume exceeds capacity, queue may be longer.

Queue shown is maximum after two cycles.

m Volume for 95th percentile queue is metered by upstream signal.

HCM 6th Signalized Intersection Summary

103: Rock Island Road & Margate Boulevard

												
Movement	EBL	EBT	EBR	WBL	WBT	WBR	NBL	NBT	NBR	SBL	SBT	SBR
Lane Configurations												
Traffic Volume (veh/h)	61	40	22	172	148	157	32	924	171	114	920	93
Future Volume (veh/h)	61	40	22	172	148	157	32	924	171	114	920	93
Initial Q (Qb), veh	0	0	0	0	0	0	0	0	0	0	0	0
Ped-Bike Adj(A_pbT)	1.00		1.00	1.00		1.00	1.00		1.00	1.00		1.00
Parking Bus, Adj	1.00	1.00	1.00	1.00	1.00	1.00	1.00	1.00	1.00	1.00	1.00	1.00
Work Zone On Approach		No			No			No			No	
Adj Sat Flow, veh/h/ln	1870	1870	1870	1870	1870	1870	1870	1870	1870	1870	1870	1870
Adj Flow Rate, veh/h	66	43	24	185	159	169	34	994	184	123	989	100
Peak Hour Factor	0.93	0.93	0.93	0.93	0.93	0.93	0.93	0.93	0.93	0.93	0.93	0.93
Percent Heavy Veh, %	2	2	2	2	2	2	2	2	2	2	2	2
Cap, veh/h	143	210	108	277	221	197	391	2271	1013	384	2334	1041
Arrive On Green	0.04	0.09	0.09	0.08	0.12	0.12	0.03	0.85	0.83	0.05	0.87	0.87
Sat Flow, veh/h	1781	2268	1169	1781	1777	1585	1781	3554	1585	1781	3554	1585
Grp Volume(v), veh/h	66	33	34	185	159	169	34	994	184	123	989	100
Grp Sat Flow(s),veh/h/ln	1781	1777	1660	1781	1777	1585	1781	1777	1585	1781	1777	1585
Q Serve(g_s), s	5.3	2.7	3.0	12.0	13.8	16.7	1.1	10.7	3.7	3.9	8.9	1.4
Cycle Q Clear(g_c), s	5.3	2.7	3.0	12.0	13.8	16.7	1.1	10.7	3.7	3.9	8.9	1.4
Prop In Lane	1.00		0.70	1.00		1.00	1.00		1.00	1.00		1.00
Lane Grp Cap(c), veh/h	143	164	154	277	221	197	391	2271	1013	384	2334	1041
V/C Ratio(X)	0.46	0.20	0.22	0.67	0.72	0.86	0.09	0.44	0.18	0.32	0.42	0.10
Avail Cap(c_a), veh/h	199	378	353	277	378	337	573	2271	1013	535	2334	1041
HCM Platoon Ratio	1.00	1.00	1.00	1.00	1.00	1.00	1.33	1.33	1.30	1.33	1.33	1.33
Upstream Filter(l)	1.00	1.00	1.00	1.00	1.00	1.00	0.66	0.66	0.66	0.21	0.21	0.21
Uniform Delay (d), s/veh	62.5	67.1	67.3	61.9	67.4	68.7	9.6	5.1	5.2	9.4	4.0	3.6
Incr Delay (d2), s/veh	0.9	0.2	0.3	5.0	1.7	4.3	0.0	0.4	0.3	0.0	0.1	0.0
Initial Q Delay(d3),s/veh	0.0	0.0	0.0	0.0	0.0	0.0	0.0	0.0	0.0	0.0	0.0	0.0
%ile BackOfQ(50%),veh/ln	2.5	1.3	1.3	1.7	6.4	7.1	0.4	3.2	1.3	1.5	2.6	0.5
Unsig. Movement Delay, s/veh												
LnGrp Delay(d),s/veh	63.3	67.3	67.5	66.9	69.1	73.0	9.6	5.5	5.5	9.4	4.2	3.6
LnGrp LOS	E	E	E	E	E	E	A	A	A	A	A	A
Approach Vol, veh/h		133			513			1212			1212	
Approach Delay, s/veh		65.4			69.6			5.6			4.6	
Approach LOS		E			E			A			A	
Timer - Assigned Phs	1	2	3	4	5	6	7	8				
Phs Duration (G+Y+Rc), s	12.4	108.8	18.0	20.8	9.6	111.6	12.9	25.9				
Change Period (Y+Rc), s	6.5	6.5	6.0	6.0	6.5	6.5	6.0	6.0				
Max Green Setting (Gmax), s	19.5	69.5	12.0	34.0	19.5	69.5	12.0	34.0				
Max Q Clear Time (g_c+I1), s	5.9	12.7	14.0	5.0	3.1	10.9	7.3	18.7				
Green Ext Time (p_c), s	0.1	10.4	0.0	0.2	0.0	9.9	0.0	1.1				
Intersection Summary												
HCM 6th Ctrl Delay				18.5								
HCM 6th LOS				B								

Timings

104: SR 7 & Margate Boulevard



Lane Group	EBL	EBR	NBL	NBT	SBL	SBT	Ø3
Lane Configurations	↙↘	↗	↙	↑↑↑	↘	↑↑↑	
Traffic Volume (vph)	211	77	108	1762	13	2218	
Future Volume (vph)	211	77	108	1762	13	2218	
Turn Type	Prot	Perm	Prot	NA	Prot	NA	
Protected Phases	4		5	2	1	6	3
Permitted Phases		4					
Detector Phase	4	4	5	2	1	6	
Switch Phase							
Minimum Initial (s)	7.0	7.0	4.0	12.0	4.0	12.0	5.0
Minimum Split (s)	44.5	44.5	11.5	43.0	10.0	44.5	19.0
Total Split (s)	45.0	45.0	22.0	74.0	22.0	74.0	19.0
Total Split (%)	28.1%	28.1%	13.8%	46.3%	13.8%	46.3%	12%
Yellow Time (s)	4.0	4.0	4.0	4.0	4.0	4.0	4.0
All-Red Time (s)	2.5	2.5	2.0	2.0	2.0	2.0	2.5
Lost Time Adjust (s)	0.0	0.0	0.0	0.0	0.0	0.0	
Total Lost Time (s)	6.5	6.5	6.0	6.0	6.0	6.0	
Lead/Lag	Lag	Lag	Lead	Lag	Lead	Lag	Lead
Lead-Lag Optimize?	Yes	Yes	Yes	Yes	Yes	Yes	Yes
Recall Mode	None	None	None	C-Max	None	C-Max	None
Act Effct Green (s)	14.6	14.6	13.9	127.9	5.3	113.0	
Actuated g/C Ratio	0.09	0.09	0.09	0.80	0.03	0.71	
v/c Ratio	0.70	0.33	0.73	0.45	0.22	0.69	
Control Delay	82.3	8.0	64.3	6.0	83.7	15.6	
Queue Delay	0.0	0.0	0.0	0.0	0.0	0.0	
Total Delay	82.3	8.0	64.3	6.0	83.7	15.6	
LOS	F	A	E	A	F	B	
Approach Delay				9.4		16.0	
Approach LOS				A		B	

Intersection Summary

Cycle Length: 160
 Actuated Cycle Length: 160
 Offset: 0 (0%), Referenced to phase 2:NBT and 6:SBT, Start of Yellow
 Natural Cycle: 150
 Control Type: Actuated-Coordinated
 Maximum v/c Ratio: 0.73
 Intersection Signal Delay: 16.2
 Intersection Capacity Utilization 72.3%
 Analysis Period (min) 15

Intersection LOS: B
 ICU Level of Service C

Splits and Phases: 104: SR 7 & Margate Boulevard

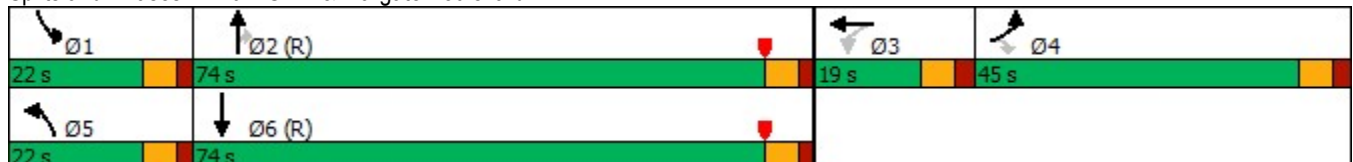

Queues

104: SR 7 & Margate Boulevard























Lane Group	EBL	EBR	NBL	NBT	SBL	SBT
Lane Group Flow (vph)	218	79	111	1816	13	2455
v/c Ratio	0.70	0.33	0.73	0.45	0.22	0.69
Control Delay	82.3	8.0	64.3	6.0	83.7	15.6
Queue Delay	0.0	0.0	0.0	0.0	0.0	0.0
Total Delay	82.3	8.0	64.3	6.0	83.7	15.6
Queue Length 50th (ft)	115	0	122	161	14	498
Queue Length 95th (ft)	159	26	m133	m227	39	670
Internal Link Dist (ft)				2153		276
Turn Bay Length (ft)	120	120	250		200	
Base Capacity (vph)	826	455	185	4064	177	3557
Starvation Cap Reductn	0	0	0	0	0	0
Spillback Cap Reductn	0	0	0	0	0	0
Storage Cap Reductn	0	0	0	0	0	0
Reduced v/c Ratio	0.26	0.17	0.60	0.45	0.07	0.69

Intersection Summary

m Volume for 95th percentile queue is metered by upstream signal.

HCM Signalized Intersection Capacity Analysis

104: SR 7 & Margate Boulevard

												
Movement	EBL	EBT	EBR	WBL	WBT	WBR	NBL	NBT	NBR	SBL	SBT	SBR
Lane Configurations												
Traffic Volume (vph)	211	0	77	0	0	0	108	1762	0	13	2218	163
Future Volume (vph)	211	0	77	0	0	0	108	1762	0	13	2218	163
Ideal Flow (vphpl)	1900	1900	1900	1900	1900	1900	1900	1900	1900	1900	1900	1900
Total Lost time (s)	6.5		6.5				6.0	6.0		6.0	6.0	
Lane Util. Factor	0.97		1.00				1.00	0.91		1.00	0.91	
Frbp, ped/bikes	1.00		0.99				1.00	1.00		1.00	1.00	
Flpb, ped/bikes	1.00		1.00				1.00	1.00		1.00	1.00	
Frt	1.00		0.85				1.00	1.00		1.00	0.99	
Flt Protected	0.95		1.00				0.95	1.00		0.95	1.00	
Satd. Flow (prot)	3433		1560				1770	5085		1770	5033	
Flt Permitted	0.95		1.00				0.95	1.00		0.95	1.00	
Satd. Flow (perm)	3433		1560				1770	5085		1770	5033	
Peak-hour factor, PHF	0.97	0.97	0.97	0.97	0.97	0.97	0.97	0.97	0.97	0.97	0.97	0.97
Adj. Flow (vph)	218	0	79	0	0	0	111	1816	0	13	2287	168
RTOR Reduction (vph)	0	0	72	0	0	0	0	0	0	0	3	0
Lane Group Flow (vph)	218	0	7	0	0	0	111	1816	0	13	2452	0
Confl. Peds. (#/hr)			2	2								
Turn Type	Prot		Perm				Prot	NA	Perm	Prot	NA	
Protected Phases	4				3		5	2		1	6	
Permitted Phases			4	3					2			
Actuated Green, G (s)	14.6		14.6				13.9	124.3		2.6	113.0	
Effective Green, g (s)	14.6		14.6				13.9	124.3		2.6	113.0	
Actuated g/C Ratio	0.09		0.09				0.09	0.78		0.02	0.71	
Clearance Time (s)	6.5		6.5				6.0	6.0		6.0	6.0	
Vehicle Extension (s)	2.0		2.0				1.5	3.0		1.5	3.0	
Lane Grp Cap (vph)	313		142				153	3950		28	3554	
v/s Ratio Prot	c0.06						c0.06	0.36		0.01	c0.49	
v/s Ratio Perm			0.00									
v/c Ratio	0.70		0.05				0.73	0.46		0.46	0.69	
Uniform Delay, d1	70.5		66.4				71.2	6.2		78.0	13.5	
Progression Factor	1.00		1.00				0.74	1.01		1.00	1.00	
Incremental Delay, d2	5.4		0.1				6.1	0.2		4.4	1.1	
Delay (s)	75.9		66.4				58.9	6.4		82.4	14.6	
Level of Service	E		E				E	A		F	B	
Approach Delay (s)		73.4			0.0			9.4			14.9	
Approach LOS		E			A			A			B	
Intersection Summary												
HCM 2000 Control Delay			16.4				HCM 2000 Level of Service			B		
HCM 2000 Volume to Capacity ratio			0.73									
Actuated Cycle Length (s)			160.0				Sum of lost time (s)			25.0		
Intersection Capacity Utilization			72.3%				ICU Level of Service			C		
Analysis Period (min)			15									
c Critical Lane Group												

HCM 6th Signalized Intersection Summary
104: SR 7 & Margate Boulevard

HCM 6th Edition methodology expects strict NEMA phasing.

Timings

105: Riverside Drive & Atlantic Boulevard /Atlantic Boulevard

Lane Group	EBL	EBT	EBR	WBL	WBT	WBR	NBL	NBT	NBR	SBL	SBT	SBR
Lane Configurations												
Traffic Volume (vph)	162	1001	67	256	948	338	60	700	247	320	517	187
Future Volume (vph)	162	1001	67	256	948	338	60	700	247	320	517	187
Turn Type	Prot	NA	Perm	Prot	NA	Perm	Prot	NA	Perm	Prot	NA	Perm
Protected Phases	1	6		5	2		7	4		3	8	
Permitted Phases			6			2			4			8
Detector Phase	1	6	6	5	2	2	7	4	4	3	8	8
Switch Phase												
Minimum Initial (s)	5.0	12.0	12.0	5.0	12.0	12.0	4.0	6.0	6.0	5.0	6.0	6.0
Minimum Split (s)	11.0	36.0	36.0	24.0	36.0	36.0	10.0	32.0	32.0	11.0	20.0	20.0
Total Split (s)	60.0	50.0	50.0	60.0	50.0	50.0	30.0	32.0	32.0	18.0	20.0	20.0
Total Split (%)	37.5%	31.3%	31.3%	37.5%	31.3%	31.3%	18.8%	20.0%	20.0%	11.3%	12.5%	12.5%
Yellow Time (s)	4.0	5.0	5.0	4.0	5.0	5.0	4.0	5.0	5.0	4.0	5.0	5.0
All-Red Time (s)	2.0	2.0	2.0	2.0	2.0	2.0	2.0	2.0	2.0	2.0	2.0	2.0
Lost Time Adjust (s)	0.0	0.0	0.0	0.0	0.0	0.0	0.0	0.0	0.0	0.0	0.0	0.0
Total Lost Time (s)	6.0	7.0	7.0	6.0	7.0	7.0	6.0	7.0	7.0	6.0	7.0	7.0
Lead/Lag	Lead	Lag	Lag	Lead	Lag	Lag	Lead	Lag	Lag	Lead	Lag	Lag
Lead-Lag Optimize?	Yes	Yes	Yes	Yes	Yes	Yes	Yes	Yes	Yes	Yes	Yes	Yes
Recall Mode	None	C-Max	C-Max	None	C-Max	C-Max	None	None	None	None	None	None
Act Effct Green (s)	11.8	80.6	80.6	16.4	85.2	85.2	6.8	25.0	25.0	12.0	32.3	32.3
Actuated g/C Ratio	0.07	0.50	0.50	0.10	0.53	0.53	0.04	0.16	0.16	0.08	0.20	0.20
v/c Ratio	0.66	0.40	0.08	0.75	0.36	0.35	0.43	1.31	0.58	1.28	0.75	0.41
Control Delay	84.6	25.7	0.2	105.4	13.3	4.1	83.2	201.5	15.2	208.9	67.9	9.7
Queue Delay	0.0	0.0	0.0	0.0	0.0	0.0	0.0	0.0	0.0	0.0	0.0	0.0
Total Delay	84.6	25.7	0.2	105.4	13.3	4.1	83.2	201.5	15.2	208.9	67.9	9.7
LOS	F	C	A	F	B	A	F	F	B	F	E	A
Approach Delay		32.1			26.6			148.7			101.3	
Approach LOS		C			C			F			F	

Intersection Summary

Cycle Length: 160

Actuated Cycle Length: 160

Offset: 0 (0%), Referenced to phase 2:WBT and 6:EBT, Start of Yellow

Natural Cycle: 105

Control Type: Actuated-Coordinated

Maximum v/c Ratio: 1.31

Intersection Signal Delay: 69.6

Intersection LOS: E

Intersection Capacity Utilization 77.6%

ICU Level of Service D

Analysis Period (min) 15

Splits and Phases: 105: Riverside Drive & Atlantic Boulevard /Atlantic Boulevard

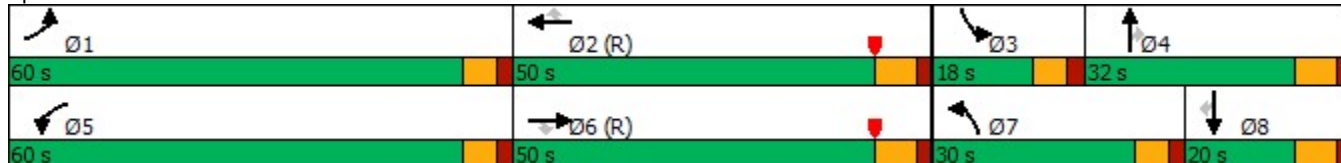

Queues

105: Riverside Drive & Atlantic Boulevard /Atlantic Boulevard



Lane Group	EBL	EBT	EBR	WBL	WBT	WBR	NBL	NBT	NBR	SBL	SBT	SBR
Lane Group Flow (vph)	167	1032	69	264	977	348	62	722	255	330	533	193
v/c Ratio	0.66	0.40	0.08	0.75	0.36	0.35	0.43	1.31	0.58	1.28	0.75	0.41
Control Delay	84.6	25.7	0.2	105.4	13.3	4.1	83.2	201.5	15.2	208.9	67.9	9.7
Queue Delay	0.0	0.0	0.0	0.0	0.0	0.0	0.0	0.0	0.0	0.0	0.0	0.0
Total Delay	84.6	25.7	0.2	105.4	13.3	4.1	83.2	201.5	15.2	208.9	67.9	9.7
Queue Length 50th (ft)	89	241	0	150	129	50	33	~508	20	~224	284	0
Queue Length 95th (ft)	128	297	0	201	158	84	59	#641	113	#330	#378	73
Internal Link Dist (ft)		1763			2560			1528			1193	
Turn Bay Length (ft)	250		300	220		270	300		300	300		300
Base Capacity (vph)	1158	2560	861	1158	2708	1005	514	552	440	257	714	469
Starvation Cap Reductn	0	0	0	0	0	0	0	0	0	0	0	0
Spillback Cap Reductn	0	0	0	0	0	0	0	0	0	0	0	0
Storage Cap Reductn	0	0	0	0	0	0	0	0	0	0	0	0
Reduced v/c Ratio	0.14	0.40	0.08	0.23	0.36	0.35	0.12	1.31	0.58	1.28	0.75	0.41

Intersection Summary

~ Volume exceeds capacity, queue is theoretically infinite.

























Queue shown is maximum after two cycles.

95th percentile volume exceeds capacity, queue may be longer.

Queue shown is maximum after two cycles.

HCM 6th Signalized Intersection Summary

105: Riverside Drive & Atlantic Boulevard /Atlantic Boulevard

												
Movement	EBL	EBT	EBR	WBL	WBT	WBR	NBL	NBT	NBR	SBL	SBT	SBR
Lane Configurations												
Traffic Volume (veh/h)	162	1001	67	256	948	338	60	700	247	320	517	187
Future Volume (veh/h)	162	1001	67	256	948	338	60	700	247	320	517	187
Initial Q (Qb), veh	0	0	0	0	0	0	0	0	0	0	0	0
Ped-Bike Adj(A_pbT)	1.00		0.99	1.00		1.00	1.00		0.99	1.00		0.98
Parking Bus, Adj	1.00	1.00	1.00	1.00	1.00	1.00	1.00	1.00	1.00	1.00	1.00	1.00
Work Zone On Approach		No			No			No			No	
Adj Sat Flow, veh/h/ln	1870	1870	1870	1870	1870	1870	1870	1870	1870	1870	1870	1870
Adj Flow Rate, veh/h	167	1032	69	264	977	348	62	722	255	330	533	193
Peak Hour Factor	0.97	0.97	0.97	0.97	0.97	0.97	0.97	0.97	0.97	0.97	0.97	0.97
Percent Heavy Veh, %	2	2	2	2	2	2	2	2	2	2	2	2
Cap, veh/h	211	2639	809	309	2783	864	99	555	246	259	720	316
Arrive On Green	0.08	0.69	0.69	0.12	0.72	0.72	0.03	0.16	0.16	0.08	0.20	0.20
Sat Flow, veh/h	3456	5106	1565	3456	5106	1585	3456	3554	1576	3456	3554	1557
Grp Volume(v), veh/h	167	1032	69	264	977	348	62	722	255	330	533	193
Grp Sat Flow(s),veh/h/ln	1728	1702	1565	1728	1702	1585	1728	1777	1576	1728	1777	1557
Q Serve(g_s), s	7.6	13.8	2.3	12.0	11.3	13.6	2.8	25.0	25.0	12.0	22.5	18.0
Cycle Q Clear(g_c), s	7.6	13.8	2.3	12.0	11.3	13.6	2.8	25.0	25.0	12.0	22.5	18.0
Prop In Lane	1.00		1.00	1.00		1.00	1.00		1.00	1.00		1.00
Lane Grp Cap(c), veh/h	211	2639	809	309	2783	864	99	555	246	259	720	316
V/C Ratio(X)	0.79	0.39	0.09	0.85	0.35	0.40	0.63	1.30	1.04	1.27	0.74	0.61
Avail Cap(c_a), veh/h	1166	2639	809	1166	2783	864	518	555	246	259	720	316
HCM Platoon Ratio	1.33	1.33	1.33	1.33	1.33	1.33	1.00	1.00	1.00	1.00	1.00	1.00
Upstream Filter(l)	1.00	1.00	1.00	0.83	0.83	0.83	1.00	1.00	1.00	1.00	1.00	1.00
Uniform Delay (d), s/veh	72.5	14.2	12.5	69.5	11.6	11.9	76.9	67.5	67.5	74.0	59.8	58.1
Incr Delay (d2), s/veh	2.5	0.4	0.2	2.2	0.3	1.2	2.4	147.9	66.9	149.6	3.6	2.5
Initial Q Delay(d3),s/veh	0.0	0.0	0.0	0.0	0.0	0.0	0.0	0.0	0.0	0.0	0.0	0.0
%ile BackOfQ(50%),veh/ln	3.4	4.9	0.9	5.3	3.9	4.5	1.3	22.8	14.7	10.7	10.6	7.4
Unsig. Movement Delay, s/veh												
LnGrp Delay(d),s/veh	75.0	14.7	12.7	71.7	11.9	13.0	79.3	215.4	134.4	223.6	63.4	60.6
LnGrp LOS	E	B	B	E	B	B	E	F	F	F	E	E
Approach Vol, veh/h		1268			1589			1039			1056	
Approach Delay, s/veh		22.5			22.0			187.4			113.0	
Approach LOS		C			C			F			F	
Timer - Assigned Phs	1	2	3	4	5	6	7	8				
Phs Duration (G+Y+Rc), s	15.8	94.2	18.0	32.0	20.3	89.7	10.6	39.4				
Change Period (Y+Rc), s	6.0	7.0	6.0	7.0	6.0	7.0	6.0	7.0				
Max Green Setting (Gmax), s	54.0	43.0	12.0	25.0	54.0	43.0	24.0	13.0				
Max Q Clear Time (g_c+I1), s	9.6	15.6	14.0	27.0	14.0	15.8	4.8	24.5				
Green Ext Time (p_c), s	0.2	9.6	0.0	0.0	0.3	8.7	0.0	0.0				
Intersection Summary												
HCM 6th Ctrl Delay				76.3								
HCM 6th LOS				E								
Notes												
User approved pedestrian interval to be less than phase max green.												

Timings

106: Ramblewood Drive & Atlantic Boulevard

Lane Group	EBL	EBT	WBL	WBT	NBL	NBT	NBR	SBL	SBT	SBR
Lane Configurations										
Traffic Volume (vph)	51	1470	99	1727	22	9	24	118	17	57
Future Volume (vph)	51	1470	99	1727	22	9	24	118	17	57
Turn Type	pm+pt	NA	pm+pt	NA	Perm	NA	Perm	Perm	NA	Perm
Protected Phases	1	6	5	2		4			8	
Permitted Phases	6		2		4		4	8		8
Detector Phase	1	6	5	2	4	4	4	8	8	8
Switch Phase										
Minimum Initial (s)	4.0	12.0	4.0	12.0	6.0	6.0	6.0	6.0	6.0	6.0
Minimum Split (s)	11.0	45.0	11.0	45.0	36.0	36.0	36.0	36.0	36.0	36.0
Total Split (s)	25.0	85.0	25.0	85.0	50.0	50.0	50.0	50.0	50.0	50.0
Total Split (%)	15.6%	53.1%	15.6%	53.1%	31.3%	31.3%	31.3%	31.3%	31.3%	31.3%
Yellow Time (s)	5.0	5.0	5.0	5.0	4.0	4.0	4.0	4.0	4.0	4.0
All-Red Time (s)	2.0	2.0	2.0	2.0	2.0	2.0	2.0	2.0	2.0	2.0
Lost Time Adjust (s)	0.0	0.0	0.0	0.0	0.0	0.0	0.0	0.0	0.0	0.0
Total Lost Time (s)	7.0	7.0	7.0	7.0	6.0	6.0	6.0	6.0	6.0	6.0
Lead/Lag	Lead	Lag	Lead	Lag						
Lead-Lag Optimize?	Yes	Yes	Yes	Yes						
Recall Mode	None	C-Max	None	C-Max	None	None	None	None	None	None
Act Effct Green (s)	119.4	113.7	122.2	116.6	19.9	19.9	19.9	19.9	19.9	19.9
Actuated g/C Ratio	0.75	0.71	0.76	0.73	0.12	0.12	0.12	0.12	0.12	0.12
v/c Ratio	0.33	0.45	0.44	0.55	0.13	0.02	0.10	0.73	0.08	0.24
Control Delay	12.1	2.5	12.9	2.7	61.1	57.8	0.8	90.1	59.4	9.2
Queue Delay	0.0	0.0	0.0	0.0	0.0	0.0	0.0	0.0	0.0	0.0
Total Delay	12.1	2.5	12.9	2.7	61.1	57.8	0.8	90.1	59.4	9.2
LOS	B	A	B	A	E	E	A	F	E	A
Approach Delay		2.8		3.2		34.0			63.3	
Approach LOS		A		A		C			E	

Intersection Summary

Cycle Length: 160

Actuated Cycle Length: 160

Offset: 80 (50%), Referenced to phase 2:WBTL and 6:EBTL, Start of Yellow

Natural Cycle: 95

Control Type: Actuated-Coordinated

Maximum v/c Ratio: 0.73

Intersection Signal Delay: 6.6

Intersection LOS: A

Intersection Capacity Utilization 70.9%

ICU Level of Service C

Analysis Period (min) 15

Splits and Phases: 106: Ramblewood Drive & Atlantic Boulevard

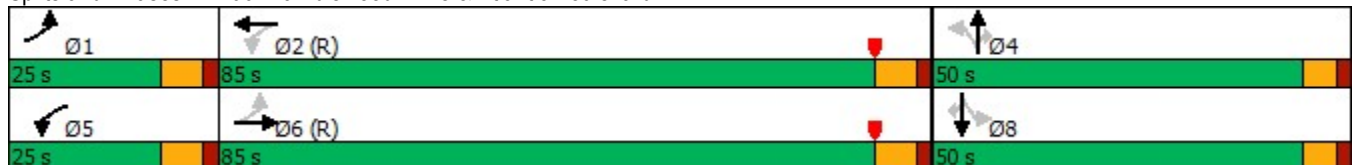

Queues

106: Ramblewood Drive & Atlantic Boulevard































Lane Group	EBL	EBT	WBL	WBT	NBL	NBT	NBR	SBL	SBT	SBR
Lane Group Flow (vph)	54	1604	105	2007	23	10	26	126	18	61
v/c Ratio	0.33	0.45	0.44	0.55	0.13	0.02	0.10	0.73	0.08	0.24
Control Delay	12.1	2.5	12.9	2.7	61.1	57.8	0.8	90.1	59.4	9.2
Queue Delay	0.0	0.0	0.0	0.0	0.0	0.0	0.0	0.0	0.0	0.0
Total Delay	12.1	2.5	12.9	2.7	61.1	57.8	0.8	90.1	59.4	9.2
Queue Length 50th (ft)	3	36	5	28	22	4	0	129	17	0
Queue Length 95th (ft)	m15	m63	44	48	49	14	0	196	41	31
Internal Link Dist (ft)		2560		3088		436			532	
Turn Bay Length (ft)	180		180		200		425	180		275
Base Capacity (vph)	295	3599	356	3657	380	973	483	384	512	483
Starvation Cap Reductn	0	0	0	0	0	0	0	0	0	0
Spillback Cap Reductn	0	0	0	0	0	0	0	0	0	0
Storage Cap Reductn	0	0	0	0	0	0	0	0	0	0
Reduced v/c Ratio	0.18	0.45	0.29	0.55	0.06	0.01	0.05	0.33	0.04	0.13

Intersection Summary

m Volume for 95th percentile queue is metered by upstream signal.

HCM 6th Signalized Intersection Summary

106: Ramblewood Drive & Atlantic Boulevard

												
Movement	EBL	EBT	EBR	WBL	WBT	WBR	NBL	NBT	NBR	SBL	SBT	SBR
Lane Configurations		  			  			 			 	
Traffic Volume (veh/h)	51	1470	38	99	1727	160	22	9	24	118	17	57
Future Volume (veh/h)	51	1470	38	99	1727	160	22	9	24	118	17	57
Initial Q (Qb), veh	0	0	0	0	0	0	0	0	0	0	0	0
Ped-Bike Adj(A_pbT)	1.00		1.00	1.00		0.99	1.00		0.99	1.00		0.99
Parking Bus, Adj	1.00	1.00	1.00	1.00	1.00	1.00	1.00	1.00	1.00	1.00	1.00	1.00
Work Zone On Approach		No			No			No			No	
Adj Sat Flow, veh/h/ln	1870	1870	1870	1870	1870	1870	1870	1870	1870	1870	1870	1870
Adj Flow Rate, veh/h	54	1564	40	105	1837	170	23	10	26	126	18	61
Peak Hour Factor	0.94	0.94	0.94	0.94	0.94	0.94	0.94	0.94	0.94	0.94	0.94	0.94
Percent Heavy Veh, %	2	2	2	2	2	2	2	2	2	2	2	2
Cap, veh/h	239	3744	96	322	3498	322	186	412	183	200	217	183
Arrive On Green	0.03	0.97	0.97	0.04	0.98	0.98	0.12	0.12	0.12	0.12	0.12	0.12
Sat Flow, veh/h	1781	5120	131	1781	4751	438	1314	3554	1577	1365	1870	1577
Grp Volume(v), veh/h	54	1040	564	105	1314	693	23	10	26	126	18	61
Grp Sat Flow(s),veh/h/ln	1781	1702	1847	1781	1702	1785	1314	1777	1577	1365	1870	1577
Q Serve(g_s), s	1.2	2.3	2.3	2.4	2.6	2.7	2.5	0.4	2.4	14.4	1.4	5.7
Cycle Q Clear(g_c), s	1.2	2.3	2.3	2.4	2.6	2.7	3.9	0.4	2.4	14.8	1.4	5.7
Prop In Lane	1.00		0.07	1.00		0.25	1.00		1.00	1.00		1.00
Lane Grp Cap(c), veh/h	239	2489	1350	322	2507	1314	186	412	183	200	217	183
V/C Ratio(X)	0.23	0.42	0.42	0.33	0.52	0.53	0.12	0.02	0.14	0.63	0.08	0.33
Avail Cap(c_a), veh/h	399	2489	1350	472	2507	1314	395	977	434	417	514	434
HCM Platoon Ratio	1.33	1.33	1.33	1.33	1.33	1.33	1.00	1.00	1.00	1.00	1.00	1.00
Upstream Filter(I)	0.76	0.76	0.76	0.80	0.80	0.80	1.00	1.00	1.00	1.00	1.00	1.00
Uniform Delay (d), s/veh	5.0	0.6	0.6	4.9	0.5	0.5	64.9	62.7	63.6	69.3	63.1	65.0
Incr Delay (d2), s/veh	0.1	0.4	0.7	0.2	0.6	1.2	0.3	0.0	0.4	3.3	0.2	1.1
Initial Q Delay(d3),s/veh	0.0	0.0	0.0	0.0	0.0	0.0	0.0	0.0	0.0	0.0	0.0	0.0
%ile BackOfQ(50%),veh/ln	0.5	0.6	0.8	0.9	0.7	0.9	0.9	0.2	1.0	5.2	0.7	0.1
Unsig. Movement Delay, s/veh												
LnGrp Delay(d),s/veh	5.1	1.0	1.3	5.1	1.1	1.7	65.2	62.7	63.9	72.5	63.3	66.1
LnGrp LOS	A	A	A	A	A	A	E	E	E	E	E	E
Approach Vol, veh/h		1658			2112			59			205	
Approach Delay, s/veh		1.3			1.5			64.2			69.8	
Approach LOS		A			A			E			E	
Timer - Assigned Phs	1	2		4	5	6		8				
Phs Duration (G+Y+Rc), s	10.6	124.8		24.5	11.5	124.0		24.5				
Change Period (Y+Rc), s	7.0	7.0		6.0	7.0	7.0		6.0				
Max Green Setting (Gmax), s	18.0	78.0		44.0	18.0	78.0		44.0				
Max Q Clear Time (g_c+I1), s	3.2	4.7		5.9	4.4	4.3		16.8				
Green Ext Time (p_c), s	0.0	30.1		0.2	0.1	19.0		0.6				
Intersection Summary												
HCM 6th Ctrl Delay			5.8									
HCM 6th LOS			A									

Timings

107: NW 76 Avenue & Atlantic Boulevard



Lane Group	EBL	EBT	WBL	WBT	NBL	NBT	SBL	SBT	SBR
Lane Configurations	↖	↕↕↕	↖	↕↕↕	↖	↗	↖	↕	↗
Traffic Volume (vph)	124	1522	7	1884	33	10	67	7	148
Future Volume (vph)	124	1522	7	1884	33	10	67	7	148
Turn Type	Prot	NA	Prot	NA	Perm	NA	Perm	NA	Perm
Protected Phases	1	6	5	2		4		8	
Permitted Phases					4		8		8
Detector Phase	1	6	5	2	4	4	8	8	8
Switch Phase									
Minimum Initial (s)	4.0	12.0	4.0	12.0	6.0	6.0	6.0	6.0	6.0
Minimum Split (s)	24.0	28.0	10.0	28.0	43.0	43.0	43.0	43.0	43.0
Total Split (s)	25.0	98.0	16.0	89.0	46.0	46.0	46.0	46.0	46.0
Total Split (%)	15.6%	61.3%	10.0%	55.6%	28.8%	28.8%	28.8%	28.8%	28.8%
Yellow Time (s)	4.0	4.0	4.0	4.0	4.0	4.0	4.0	4.0	4.0
All-Red Time (s)	2.0	2.0	2.0	2.0	2.0	2.0	2.0	2.0	2.0
Lost Time Adjust (s)	0.0	0.0	0.0	0.0	0.0	0.0	0.0	0.0	0.0
Total Lost Time (s)	6.0	6.0	6.0	6.0	6.0	6.0	6.0	6.0	6.0
Lead/Lag	Lead	Lag	Lead	Lag					
Lead-Lag Optimize?	Yes	Yes	Yes	Yes					
Recall Mode	None	C-Max	None	C-Max	None	None	None	None	None
Act Effct Green (s)	15.3	133.3	4.8	114.3	12.3	12.3	12.3	12.3	12.3
Actuated g/C Ratio	0.10	0.83	0.03	0.71	0.08	0.08	0.08	0.08	0.08
v/c Ratio	0.75	0.38	0.13	0.57	0.32	0.16	0.64	0.05	0.58
Control Delay	113.3	1.3	62.0	8.8	75.6	41.0	97.1	65.9	18.6
Queue Delay	0.0	0.0	0.0	0.0	0.0	0.0	0.0	0.0	0.0
Total Delay	113.3	1.3	62.0	8.8	75.6	41.0	97.1	65.9	18.6
LOS	F	A	E	A	E	D	F	E	B
Approach Delay		9.6		8.9		61.6		43.7	
Approach LOS		A		A		E		D	

Intersection Summary

Cycle Length: 160

Actuated Cycle Length: 160

Offset: 5 (3%), Referenced to phase 2:WBT and 6:EBT, Start of Yellow

Natural Cycle: 115

Control Type: Actuated-Coordinated

Maximum v/c Ratio: 0.75

Intersection Signal Delay: 11.9

Intersection LOS: B

Intersection Capacity Utilization 72.1%

ICU Level of Service C

Analysis Period (min) 15

Splits and Phases: 107: NW 76 Avenue & Atlantic Boulevard



Queues

107: NW 76 Avenue & Atlantic Boulevard



Lane Group	EBL	EBT	WBL	WBT	NBL	NBT	SBL	SBT	SBR
Lane Group Flow (vph)	127	1593	7	2038	34	23	68	7	151
v/c Ratio	0.75	0.38	0.13	0.57	0.32	0.16	0.64	0.05	0.58
Control Delay	113.3	1.3	62.0	8.8	75.6	41.0	97.1	65.9	18.6
Queue Delay	0.0	0.0	0.0	0.0	0.0	0.0	0.0	0.0	0.0
Total Delay	113.3	1.3	62.0	8.8	75.6	41.0	97.1	65.9	18.6
Queue Length 50th (ft)	132	29	8	173	34	10	70	7	0
Queue Length 95th (ft)	192	40	m6	m189	71	40	123	24	71
Internal Link Dist (ft)		3088		2032		396		487	
Turn Bay Length (ft)	150		200		225		200		200
Base Capacity (vph)	215	4216	110	3598	350	431	343	465	504
Starvation Cap Reductn	0	0	0	0	0	0	0	0	0
Spillback Cap Reductn	0	0	0	0	0	0	0	0	0
Storage Cap Reductn	0	0	0	0	0	0	0	0	0
Reduced v/c Ratio	0.59	0.38	0.06	0.57	0.10	0.05	0.20	0.02	0.30

Intersection Summary

m Volume for 95th percentile queue is metered by upstream signal.

HCM 6th Signalized Intersection Summary

107: NW 76 Avenue & Atlantic Boulevard

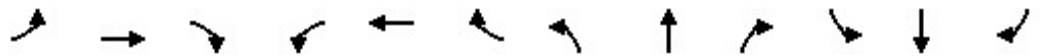

Movement	EBL	EBT	EBR	WBL	WBT	WBR	NBL	NBT	NBR	SBL	SBT	SBR
Lane Configurations	↗	↑↑↑		↖	↑↑↑		↖	↑		↗	↑	↗
Traffic Volume (veh/h)	124	1522	39	7	1884	114	33	10	13	67	7	148
Future Volume (veh/h)	124	1522	39	7	1884	114	33	10	13	67	7	148
Initial Q (Qb), veh	0	0	0	0	0	0	0	0	0	0	0	0
Ped-Bike Adj(A_pbT)	1.00		0.98	1.00		1.00	0.99		0.99	0.99		0.98
Parking Bus, Adj	1.00	1.00	1.00	1.00	1.00	1.00	1.00	1.00	1.00	1.00	1.00	1.00
Work Zone On Approach		No			No			No			No	
Adj Sat Flow, veh/h/ln	1870	1870	1870	1870	1870	1870	1870	1870	1870	1870	1870	1870
Adj Flow Rate, veh/h	127	1553	40	7	1922	116	34	10	13	68	7	151
Peak Hour Factor	0.98	0.98	0.98	0.98	0.98	0.98	0.98	0.98	0.98	0.98	0.98	0.98
Percent Heavy Veh, %	2	2	2	2	2	2	2	2	2	2	2	2
Cap, veh/h	148	3845	99	12	3326	200	199	95	123	206	242	200
Arrive On Green	0.11	1.00	1.00	0.01	0.90	0.90	0.13	0.13	0.13	0.13	0.13	0.13
Sat Flow, veh/h	1781	5116	132	1781	4925	296	1219	734	954	1376	1870	1549
Grp Volume(v), veh/h	127	1033	560	7	1327	711	34	0	23	68	7	151
Grp Sat Flow(s),veh/h/ln	1781	1702	1843	1781	1702	1817	1219	0	1688	1376	1870	1549
Q Serve(g_s), s	11.2	0.0	0.0	0.6	13.2	13.3	4.0	0.0	1.9	7.3	0.5	15.1
Cycle Q Clear(g_c), s	11.2	0.0	0.0	0.6	13.2	13.3	4.5	0.0	1.9	9.3	0.5	15.1
Prop In Lane	1.00		0.07	1.00		0.16	1.00		0.57	1.00		1.00
Lane Grp Cap(c), veh/h	148	2559	1386	12	2299	1227	199	0	218	206	242	200
V/C Ratio(X)	0.86	0.40	0.40	0.59	0.58	0.58	0.17	0.00	0.11	0.33	0.03	0.75
Avail Cap(c_a), veh/h	212	2559	1386	111	2299	1227	346	0	422	373	468	387
HCM Platoon Ratio	1.33	1.33	1.33	1.33	1.33	1.33	1.00	1.00	1.00	1.00	1.00	1.00
Upstream Filter(l)	0.89	0.89	0.89	0.09	0.09	0.09	1.00	0.00	1.00	1.00	1.00	1.00
Uniform Delay (d), s/veh	70.3	0.0	0.0	79.1	3.3	3.3	62.9	0.0	61.5	65.6	60.9	67.2
Incr Delay (d2), s/veh	14.4	0.4	0.8	1.5	0.1	0.2	0.2	0.0	0.1	0.3	0.0	2.2
Initial Q Delay(d3),s/veh	0.0	0.0	0.0	0.0	0.0	0.0	0.0	0.0	0.0	0.0	0.0	0.0
%ile BackOfQ(50%),veh/ln	5.6	0.2	0.3	0.3	2.8	3.0	1.3	0.0	0.8	2.6	0.3	6.1
Unsig. Movement Delay, s/veh												
LnGrp Delay(d),s/veh	84.7	0.4	0.8	80.6	3.4	3.5	63.0	0.0	61.6	65.9	60.9	69.4
LnGrp LOS	F	A	A	F	A	A	E	A	E	E	E	E
Approach Vol, veh/h		1720			2045			57			226	
Approach Delay, s/veh		6.8			3.7			62.4			68.1	
Approach LOS		A			A			E			E	
Timer - Assigned Phs	1	2		4	5	6		8				
Phs Duration (G+Y+Rc), s	19.3	114.1		26.7	7.1	126.3		26.7				
Change Period (Y+Rc), s	6.0	6.0		6.0	6.0	6.0		6.0				
Max Green Setting (Gmax), s	19.0	83.0		40.0	10.0	92.0		40.0				
Max Q Clear Time (g_c+I1), s	13.2	15.3		6.5	2.6	2.0		17.1				
Green Ext Time (p_c), s	0.0	30.0		0.1	0.0	19.1		0.4				
Intersection Summary												
HCM 6th Ctrl Delay				9.4								
HCM 6th LOS				A								

Timings

108: Rock Island Road & Atlantic Boulevard/Atlantic Boulevard



Lane Group	EBL	EBT	WBL	WBT	NBL	NBT	NBR	SBL	SBT
Lane Configurations	↖↗	↕↔	↖↗	↕↔	↖↗	↕↔	↖	↖↗	↕↔
Traffic Volume (vph)	229	1022	524	1519	382	784	326	149	822
Future Volume (vph)	229	1022	524	1519	382	784	326	149	822
Turn Type	Prot	NA	Prot	NA	Prot	NA	Perm	Prot	NA
Protected Phases	1	6	5	2	7	4		3	8
Permitted Phases							4		
Detector Phase	1	6	5	2	7	4	4	3	8
Switch Phase									
Minimum Initial (s)	5.0	12.0	5.0	12.0	5.0	6.0	6.0	5.0	6.0
Minimum Split (s)	11.0	49.0	11.0	49.0	11.5	51.5	51.5	11.5	51.5
Total Split (s)	27.0	54.0	27.0	54.0	27.0	56.0	56.0	23.0	52.0
Total Split (%)	16.9%	33.8%	16.9%	33.8%	16.9%	35.0%	35.0%	14.4%	32.5%
Yellow Time (s)	4.0	4.0	4.0	4.0	4.5	4.5	4.5	4.5	4.5
All-Red Time (s)	2.0	2.0	2.0	2.0	2.0	2.0	2.0	2.0	2.0
Lost Time Adjust (s)	0.0	0.0	0.0	0.0	0.0	0.0	0.0	0.0	0.0
Total Lost Time (s)	6.0	6.0	6.0	6.0	6.5	6.5	6.5	6.5	6.5
Lead/Lag	Lead	Lag	Lead	Lag	Lead	Lag	Lag	Lead	Lag
Lead-Lag Optimize?	Yes	Yes	Yes	Yes	Yes	Yes	Yes	Yes	Yes
Recall Mode	None	C-Max	None	C-Max	None	None	None	None	None
Act Effct Green (s)	15.1	48.0	21.0	53.9	20.1	54.8	54.8	11.2	45.9
Actuated g/C Ratio	0.09	0.30	0.13	0.34	0.13	0.34	0.34	0.07	0.29
v/c Ratio	0.75	0.92	1.23	1.03	0.93	0.68	0.56	0.65	1.01
Control Delay	81.5	65.6	158.8	95.1	80.8	38.9	23.9	100.4	73.9
Queue Delay	0.0	0.0	0.0	0.0	0.0	0.0	0.0	0.0	0.0
Total Delay	81.5	65.6	158.8	95.1	80.8	38.9	23.9	100.4	73.9
LOS	F	E	F	F	F	D	C	F	E
Approach Delay		67.9		110.3		46.3			77.5
Approach LOS		E		F		D			E

Intersection Summary

Cycle Length: 160
 Actuated Cycle Length: 160
 Offset: 109 (68%), Referenced to phase 2:WBT and 6:EBT, Start of Yellow
 Natural Cycle: 145
 Control Type: Actuated-Coordinated
 Maximum v/c Ratio: 1.23
 Intersection Signal Delay: 79.2
 Intersection LOS: E
 Intersection Capacity Utilization 101.9%
 ICU Level of Service G
 Analysis Period (min) 15

Splits and Phases: 108: Rock Island Road & Atlantic Boulevard/Atlantic Boulevard

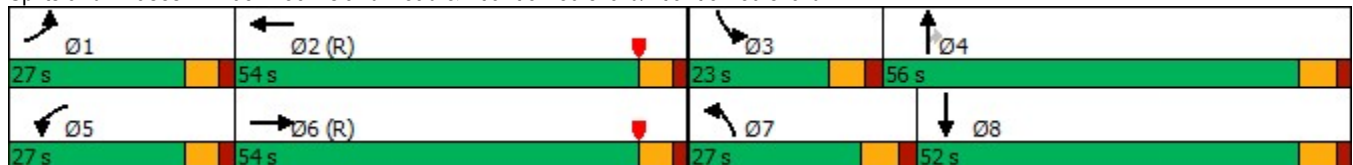

Queues

108: Rock Island Road & Atlantic Boulevard/Atlantic Boulevard



Lane Group	EBL	EBT	WBL	WBT	NBL	NBT	NBR	SBL	SBT
Lane Group Flow (vph)	241	1388	552	1753	402	825	343	157	1011
v/c Ratio	0.75	0.92	1.23	1.03	0.93	0.68	0.56	0.65	1.01
Control Delay	81.5	65.6	158.8	95.1	80.8	38.9	23.9	100.4	73.9
Queue Delay	0.0	0.0	0.0	0.0	0.0	0.0	0.0	0.0	0.0
Total Delay	81.5	65.6	158.8	95.1	80.8	38.9	23.9	100.4	73.9
Queue Length 50th (ft)	136	395	~372	~693	222	404	197	89	~581
Queue Length 95th (ft)	184	#471	m#323	m#608	m#286	m516	m303	m128	#727
Internal Link Dist (ft)		2032		5200		2618			3616
Turn Bay Length (ft)	300		300		210		23	200	
Base Capacity (vph)	450	1506	450	1695	439	1212	611	354	999
Starvation Cap Reductn	0	0	0	0	0	0	0	0	0
Spillback Cap Reductn	0	0	0	0	0	0	0	0	0
Storage Cap Reductn	0	0	0	0	0	0	0	0	0
Reduced v/c Ratio	0.54	0.92	1.23	1.03	0.92	0.68	0.56	0.44	1.01

Intersection Summary

~ Volume exceeds capacity, queue is theoretically infinite.

Queue shown is maximum after two cycles.























95th percentile volume exceeds capacity, queue may be longer.

Queue shown is maximum after two cycles.

m Volume for 95th percentile queue is metered by upstream signal.

HCM 6th Signalized Intersection Summary

108: Rock Island Road & Atlantic Boulevard/Atlantic Boulevard

												
Movement	EBL	EBT	EBR	WBL	WBT	WBR	NBL	NBT	NBR	SBL	SBT	SBR
Lane Configurations												
Traffic Volume (veh/h)	229	1022	296	524	1519	146	382	784	326	149	822	139
Future Volume (veh/h)	229	1022	296	524	1519	146	382	784	326	149	822	139
Initial Q (Qb), veh	0	0	0	0	0	0	0	0	0	0	0	0
Ped-Bike Adj(A_pbT)	1.00		1.00	1.00		0.99	1.00		1.00	1.00		1.00
Parking Bus, Adj	1.00	1.00	1.00	1.00	1.00	1.00	1.00	1.00	1.00	1.00	1.00	1.00
Work Zone On Approach		No			No			No			No	
Adj Sat Flow, veh/h/ln	1870	1870	1870	1870	1870	1870	1870	1870	1870	1870	1870	1870
Adj Flow Rate, veh/h	241	1076	312	552	1599	154	402	825	343	157	865	146
Peak Hour Factor	0.95	0.95	0.95	0.95	0.95	0.95	0.95	0.95	0.95	0.95	0.95	0.95
Percent Heavy Veh, %	2	2	2	2	2	2	2	2	2	2	2	2
Cap, veh/h	284	1179	342	454	1651	159	443	1260	561	200	865	146
Arrive On Green	0.11	0.40	0.40	0.17	0.46	0.46	0.04	0.12	0.12	0.06	0.28	0.28
Sat Flow, veh/h	3456	3929	1139	3456	4730	455	3456	3554	1582	3456	3040	513
Grp Volume(v), veh/h	241	932	456	552	1150	603	402	825	343	157	505	506
Grp Sat Flow(s),veh/h/ln	1728	1702	1664	1728	1702	1781	1728	1777	1582	1728	1777	1777
Q Serve(g_s), s	11.0	41.4	41.4	21.0	52.6	52.8	18.5	35.5	33.0	7.2	45.5	45.5
Cycle Q Clear(g_c), s	11.0	41.4	41.4	21.0	52.6	52.8	18.5	35.5	33.0	7.2	45.5	45.5
Prop In Lane	1.00		0.68	1.00		0.26	1.00		1.00	1.00		0.29
Lane Grp Cap(c), veh/h	284	1021	499	454	1188	622	443	1260	561	200	505	505
V/C Ratio(X)	0.85	0.91	0.91	1.22	0.97	0.97	0.91	0.65	0.61	0.78	1.00	1.00
Avail Cap(c_a), veh/h	454	1021	499	454	1188	622	443	1260	561	356	505	505
HCM Platoon Ratio	1.33	1.33	1.33	1.33	1.33	1.33	0.33	0.33	0.33	1.00	1.00	1.00
Upstream Filter(l)	0.93	0.93	0.93	0.09	0.09	0.09	0.52	0.52	0.52	0.88	0.88	0.88
Uniform Delay (d), s/veh	70.3	46.1	46.1	66.0	42.0	42.0	75.7	61.3	60.2	74.4	57.3	57.3
Incr Delay (d2), s/veh	4.3	12.9	22.4	99.6	3.3	5.8	13.1	0.5	0.7	2.3	37.7	37.7
Initial Q Delay(d3),s/veh	0.0	0.0	0.0	0.0	0.0	0.0	0.0	0.0	0.0	0.0	0.0	0.0
%ile BackOfQ(50%),veh/ln	4.9	18.6	19.5	15.3	21.4	22.9	9.5	17.2	14.3	3.3	25.7	25.7
Unsig. Movement Delay, s/veh												
LnGrp Delay(d),s/veh	74.6	59.0	68.5	165.7	45.3	47.9	88.8	61.8	60.9	76.6	94.9	94.9
LnGrp LOS	E	E	E	F	D	D	F	E	E	E	F	F
Approach Vol, veh/h		1629			2305			1570			1168	
Approach Delay, s/veh		64.0			74.8			68.5			92.5	
Approach LOS		E			E			E			F	
Timer - Assigned Phs	1	2	3	4	5	6	7	8				
Phs Duration (G+Y+Rc), s	19.1	61.9	15.8	63.2	27.0	54.0	27.0	52.0				
Change Period (Y+Rc), s	6.0	6.0	6.5	6.5	6.0	6.0	6.5	6.5				
Max Green Setting (Gmax), s	21.0	48.0	16.5	49.5	21.0	48.0	20.5	45.5				
Max Q Clear Time (g_c+I1), s	13.0	54.8	9.2	37.5	23.0	43.4	20.5	47.5				
Green Ext Time (p_c), s	0.2	0.0	0.1	3.8	0.0	3.3	0.0	0.0				
Intersection Summary												
HCM 6th Ctrl Delay				73.8								
HCM 6th LOS				E								

Timings

109: SR 7 & Atlantic Boulevard

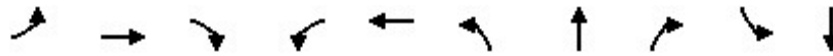

Lane Group	EBL	EBT	EBR	WBL	WBT	NBL	NBT	NBR	SBL	SBT
Lane Configurations	↔↔	↑↑↑	↔	↔↔	↑↑↑	↔	↑↑↑	↔	↔	↑↑↑
Traffic Volume (vph)	353	1021	271	671	1618	224	1318	481	133	1373
Future Volume (vph)	353	1021	271	671	1618	224	1318	481	133	1373
Turn Type	Prot	NA	Perm	Prot	NA	Prot	NA	Perm	Prot	NA
Protected Phases	7	4		3	8	5	2		1	6
Permitted Phases			4					2		
Detector Phase	7	4	4	3	8	5	2	2	1	6
Switch Phase										
Minimum Initial (s)	4.0	6.0	6.0	4.0	6.0	5.0	8.0	8.0	5.0	8.0
Minimum Split (s)	11.0	42.0	42.0	11.0	59.0	12.0	50.0	50.0	12.0	50.0
Total Split (s)	22.0	42.0	42.0	39.0	59.0	24.0	55.0	55.0	24.0	55.0
Total Split (%)	13.8%	26.3%	26.3%	24.4%	36.9%	15.0%	34.4%	34.4%	15.0%	34.4%
Yellow Time (s)	5.0	5.0	5.0	5.0	5.0	5.0	5.0	5.0	5.0	5.0
All-Red Time (s)	2.0	2.0	2.0	2.0	2.0	2.0	2.0	2.0	2.0	2.0
Lost Time Adjust (s)	0.0	0.0	0.0	0.0	0.0	0.0	0.0	0.0	0.0	0.0
Total Lost Time (s)	7.0	7.0	7.0	7.0	7.0	7.0	7.0	7.0	7.0	7.0
Lead/Lag	Lead	Lag	Lag	Lead	Lag	Lead	Lag	Lag	Lead	Lag
Lead-Lag Optimize?	Yes	Yes	Yes	Yes	Yes	Yes	Yes	Yes	Yes	Yes
Recall Mode	None	None	None	None	None	None	C-Max	C-Max	None	C-Max
Act Effct Green (s)	15.0	35.0	35.0	32.0	52.0	17.0	50.0	50.0	15.0	48.0
Actuated g/C Ratio	0.09	0.22	0.22	0.20	0.32	0.11	0.31	0.31	0.09	0.30
v/c Ratio	1.13	0.95	0.55	1.01	1.10	1.23	0.86	0.67	0.83	1.09
Control Delay	143.8	89.8	35.5	98.9	104.4	196.4	58.3	17.3	90.5	110.4
Queue Delay	0.0	0.0	0.0	0.0	0.0	0.0	0.0	0.0	0.0	0.0
Total Delay	143.8	89.8	35.5	98.9	104.4	196.4	58.3	17.3	90.5	110.4
LOS	F	F	D	F	F	F	E	B	F	F
Approach Delay		92.5			102.8		63.8			108.9
Approach LOS		F			F		E			F

Intersection Summary

Cycle Length: 160

Actuated Cycle Length: 160

Offset: 114 (71%), Referenced to phase 2:NBT and 6:SBT, Start of Yellow

Natural Cycle: 145

Control Type: Actuated-Coordinated

Maximum v/c Ratio: 1.23

Intersection Signal Delay: 91.9

Intersection LOS: F

Intersection Capacity Utilization 115.8%

ICU Level of Service H

Analysis Period (min) 15

Splits and Phases: 109: SR 7 & Atlantic Boulevard

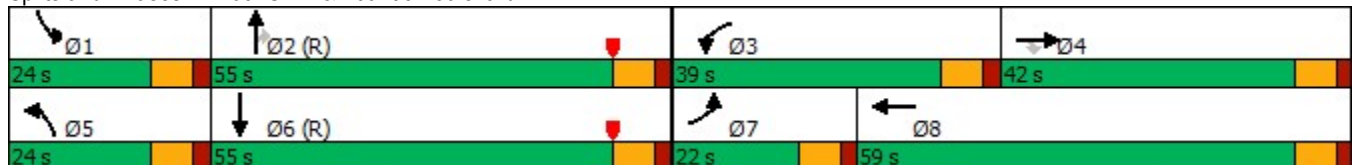

Queues

109: SR 7 & Atlantic Boulevard



Lane Group	EBL	EBT	EBR	WBL	WBT	NBL	NBT	NBR	SBL	SBT
Lane Group Flow (vph)	364	1053	279	692	1802	231	1359	496	137	1634
v/c Ratio	1.13	0.95	0.55	1.01	1.10	1.23	0.86	0.67	0.83	1.09
Control Delay	143.8	89.8	35.5	98.9	104.4	196.4	58.3	17.3	90.5	110.4
Queue Delay	0.0	0.0	0.0	0.0	0.0	0.0	0.0	0.0	0.0	0.0
Total Delay	143.8	89.8	35.5	98.9	104.4	196.4	58.3	17.3	90.5	110.4
Queue Length 50th (ft)	~232	340	106	~382	~780	~297	498	119	150	~679
Queue Length 95th (ft)	m#295	m#462	m137	#518	#875	#479	564	262	m#231	#778
Internal Link Dist (ft)		5200			1156		610			2153
Turn Bay Length (ft)	275		350	520		400		260	400	
Base Capacity (vph)	321	1112	504	686	1637	188	1588	736	188	1505
Starvation Cap Reductn	0	0	0	0	0	0	0	0	0	0
Spillback Cap Reductn	0	0	0	0	0	0	0	0	0	0
Storage Cap Reductn	0	0	0	0	0	0	0	0	0	0
Reduced v/c Ratio	1.13	0.95	0.55	1.01	1.10	1.23	0.86	0.67	0.73	1.09

Intersection Summary

~ Volume exceeds capacity, queue is theoretically infinite.

Queue shown is maximum after two cycles.



































95th percentile volume exceeds capacity, queue may be longer.

Queue shown is maximum after two cycles.

m Volume for 95th percentile queue is metered by upstream signal.

HCM 6th Signalized Intersection Summary

109: SR 7 & Atlantic Boulevard

												
Movement	EBL	EBT	EBR	WBL	WBT	WBR	NBL	NBT	NBR	SBL	SBT	SBR
Lane Configurations	  	  		  	   				  		   	
Traffic Volume (veh/h)	353	1021	271	671	1618	130	224	1318	481	133	1373	212
Future Volume (veh/h)	353	1021	271	671	1618	130	224	1318	481	133	1373	212
Initial Q (Qb), veh	0	0	0	0	0	0	0	0	0	0	0	0
Ped-Bike Adj(A_pbT)	1.00		0.99	1.00		0.99	1.00		0.99	1.00		0.99
Parking Bus, Adj	1.00	1.00	1.00	1.00	1.00	1.00	1.00	1.00	1.00	1.00	1.00	1.00
Work Zone On Approach		No			No			No			No	
Adj Sat Flow, veh/h/ln	1870	1870	1870	1870	1870	1870	1870	1870	1870	1870	1870	1870
Adj Flow Rate, veh/h	364	1053	279	692	1668	134	231	1359	496	137	1415	219
Peak Hour Factor	0.97	0.97	0.97	0.97	0.97	0.97	0.97	0.97	0.97	0.97	0.97	0.97
Percent Heavy Veh, %	2	2	2	2	2	2	2	2	2	2	2	2
Cap, veh/h	324	1117	344	691	1565	126	189	1624	501	157	1337	207
Arrive On Green	0.09	0.22	0.22	0.20	0.32	0.32	0.14	0.42	0.42	0.12	0.40	0.40
Sat Flow, veh/h	3456	5106	1572	3456	4816	386	1781	5106	1576	1781	4456	689
Grp Volume(v), veh/h	364	1053	279	692	1178	624	231	1359	496	137	1081	553
Grp Sat Flow(s),veh/h/ln	1728	1702	1572	1728	1702	1798	1781	1702	1576	1781	1702	1741
Q Serve(g_s), s	15.0	32.5	27.0	32.0	52.0	52.0	17.0	38.0	50.0	12.1	48.0	48.0
Cycle Q Clear(g_c), s	15.0	32.5	27.0	32.0	52.0	52.0	17.0	38.0	50.0	12.1	48.0	48.0
Prop In Lane	1.00		1.00	1.00		0.21	1.00		1.00	1.00		0.40
Lane Grp Cap(c), veh/h	324	1117	344	691	1106	584	189	1624	501	157	1021	522
V/C Ratio(X)	1.12	0.94	0.81	1.00	1.07	1.07	1.22	0.84	0.99	0.87	1.06	1.06
Avail Cap(c_a), veh/h	324	1117	344	691	1106	584	189	1624	501	189	1021	522
HCM Platoon Ratio	1.00	1.00	1.00	1.00	1.00	1.00	1.33	1.33	1.33	1.33	1.33	1.33
Upstream Filter(I)	0.44	0.44	0.44	1.00	1.00	1.00	1.00	1.00	1.00	0.68	0.68	0.68
Uniform Delay (d), s/veh	72.5	61.5	59.4	64.0	54.0	54.0	68.7	42.4	45.9	69.7	48.1	48.1
Incr Delay (d2), s/veh	72.6	8.0	6.3	34.5	46.2	56.5	137.3	5.3	37.6	19.6	40.3	49.3
Initial Q Delay(d3),s/veh	0.0	0.0	0.0	0.0	0.0	0.0	0.0	0.0	0.0	0.0	0.0	0.0
%ile BackOfQ(50%),veh/ln	9.9	14.9	11.4	17.4	29.3	32.6	14.8	16.1	23.8	6.3	25.1	27.0
Unsig. Movement Delay, s/veh												
LnGrp Delay(d),s/veh	145.1	69.6	65.7	98.5	100.2	110.5	206.0	47.7	83.5	89.3	88.4	97.4
LnGrp LOS	F	E	E	F	F	F	F	D	F	F	F	F
Approach Vol, veh/h		1696			2494			2086			1771	
Approach Delay, s/veh		85.1			102.3			73.8			91.3	
Approach LOS		F			F			E			F	
Timer - Assigned Phs	1	2	3	4	5	6	7	8				
Phs Duration (G+Y+Rc), s	21.1	57.9	39.0	42.0	24.0	55.0	22.0	59.0				
Change Period (Y+Rc), s	7.0	7.0	7.0	7.0	7.0	7.0	7.0	7.0				
Max Green Setting (Gmax), s	17.0	48.0	32.0	35.0	17.0	48.0	15.0	52.0				
Max Q Clear Time (g_c+I1), s	14.1	52.0	34.0	34.5	19.0	50.0	17.0	54.0				
Green Ext Time (p_c), s	0.0	0.0	0.0	0.4	0.0	0.0	0.0	0.0				
Intersection Summary												
HCM 6th Ctrl Delay			88.9									
HCM 6th LOS			F									
Notes												
User approved pedestrian interval to be less than phase max green.												

Timings

110: Southgate Boulevard & Rock Island Road

Lane Group	EBL	EBT	EBR	WBL	WBT	NBL	NBT	NBR	SBL	SBT	SBR	
Lane Configurations												
Traffic Volume (vph)	381	450	177	109	570	213	935	108	182	1054	542	
Future Volume (vph)	381	450	177	109	570	213	935	108	182	1054	542	
Turn Type	Prot	NA	Perm	Prot	NA	pm+pt	NA	Perm	pm+pt	NA	Perm	
Protected Phases	7	4		3	8	5	2		1	6		
Permitted Phases			4			2		2	6		6	
Detector Phase	7	4	4	3	8	5	2	2	1	6	6	
Switch Phase												
Minimum Initial (s)	5.0	6.0	6.0	5.0	6.0	4.0	12.0	12.0	4.0	12.0	12.0	
Minimum Split (s)	11.5	36.5	36.5	11.5	47.5	10.5	44.5	44.5	10.5	44.5	44.5	
Total Split (s)	26.0	54.0	54.0	21.0	49.0	20.0	65.0	65.0	20.0	65.0	65.0	
Total Split (%)	16.3%	33.8%	33.8%	13.1%	30.6%	12.5%	40.6%	40.6%	12.5%	40.6%	40.6%	
Yellow Time (s)	4.5	4.5	4.5	4.5	4.5	4.5	4.5	4.5	4.5	4.5	4.5	
All-Red Time (s)	2.0	2.0	2.0	2.0	2.0	2.0	2.0	2.0	2.0	2.0	2.0	
Lost Time Adjust (s)	0.0	0.0	0.0	0.0	0.0	0.0	0.0	0.0	0.0	0.0	0.0	
Total Lost Time (s)	6.5	6.5	6.5	6.5	6.5	6.5	6.5	6.5	6.5	6.5	6.5	
Lead/Lag	Lead	Lag	Lag	Lead	Lag	Lead	Lag	Lag	Lead	Lag	Lag	
Lead-Lag Optimize?	Yes	Yes	Yes	Yes	Yes	Yes	Yes	Yes	Yes	Yes	Yes	
Recall Mode	None	None	None	None	None	None	C-Max	C-Max	None	C-Max	C-Max	
Act Effct Green (s)	19.4	47.1	47.1	12.9	40.5	76.0	61.5	61.5	71.1	58.5	58.5	
Actuated g/C Ratio	0.12	0.29	0.29	0.08	0.25	0.48	0.38	0.38	0.44	0.37	0.37	
v/c Ratio	0.95	0.45	0.32	0.80	0.93	1.00	0.72	0.17	0.80	0.85	0.75	
Control Delay	102.5	47.5	10.5	108.0	72.6	103.0	46.1	6.1	47.1	50.4	28.1	
Queue Delay	0.0	0.0	0.0	0.0	0.0	0.0	0.0	0.0	0.0	0.0	0.0	
Total Delay	102.5	47.5	10.5	108.0	72.6	103.0	46.1	6.1	47.1	50.4	28.1	
LOS	F	D	B	F	E	F	D	A	D	D	C	
Approach Delay		61.8			76.9		52.3			43.2		
Approach LOS		E			E		D			D		

Intersection Summary

Cycle Length: 160

Actuated Cycle Length: 160

Offset: 80 (50%), Referenced to phase 2:NBTL and 6:SBTL, Start of Yellow

Natural Cycle: 145

Control Type: Actuated-Coordinated

Maximum v/c Ratio: 1.00

Intersection Signal Delay: 55.5

Intersection LOS: E

Intersection Capacity Utilization 96.1%

ICU Level of Service F

Analysis Period (min) 15

Splits and Phases: 110: Southgate Boulevard & Rock Island Road

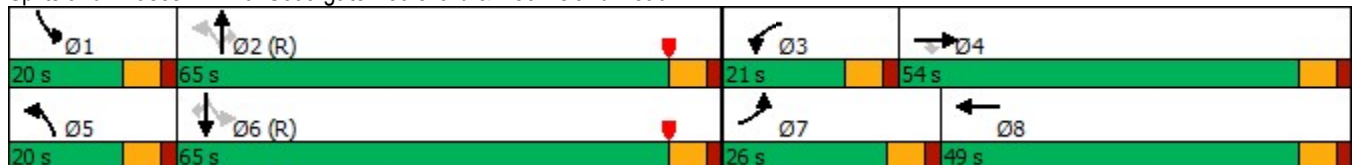

Queues

110: Southgate Boulevard & Rock Island Road



Lane Group	EBL	EBT	EBR	WBL	WBT	NBL	NBT	NBR	SBL	SBT	SBR
Lane Group Flow (vph)	397	469	184	114	819	222	974	113	190	1098	565
v/c Ratio	0.95	0.45	0.32	0.80	0.93	1.00	0.72	0.17	0.80	0.85	0.75
Control Delay	102.5	47.5	10.5	108.0	72.6	103.0	46.1	6.1	47.1	50.4	28.1
Queue Delay	0.0	0.0	0.0	0.0	0.0	0.0	0.0	0.0	0.0	0.0	0.0
Total Delay	102.5	47.5	10.5	108.0	72.6	103.0	46.1	6.1	47.1	50.4	28.1
Queue Length 50th (ft)	215	210	20	118	421	~212	468	1	137	427	226
Queue Length 95th (ft)	#321	266	84	#210	#527	#392	554	44	m134	m396	m196
Internal Link Dist (ft)		387			374		435			2618	
Turn Bay Length (ft)	310		140	220		230			170		170
Base Capacity (vph)	418	1050	574	160	925	222	1359	669	247	1293	750
Starvation Cap Reductn	0	0	0	0	0	0	0	0	0	0	0
Spillback Cap Reductn	0	0	0	0	0	0	0	0	0	0	0
Storage Cap Reductn	0	0	0	0	0	0	0	0	0	0	0
Reduced v/c Ratio	0.95	0.45	0.32	0.71	0.89	1.00	0.72	0.17	0.77	0.85	0.75

Intersection Summary

~ Volume exceeds capacity, queue is theoretically infinite.

Queue shown is maximum after two cycles.





























95th percentile volume exceeds capacity, queue may be longer.

Queue shown is maximum after two cycles.

m Volume for 95th percentile queue is metered by upstream signal.

HCM 6th Signalized Intersection Summary

110: Southgate Boulevard & Rock Island Road

												
Movement	EBL	EBT	EBR	WBL	WBT	WBR	NBL	NBT	NBR	SBL	SBT	SBR
Lane Configurations	 	 			 			 			 	
Traffic Volume (veh/h)	381	450	177	109	570	216	213	935	108	182	1054	542
Future Volume (veh/h)	381	450	177	109	570	216	213	935	108	182	1054	542
Initial Q (Qb), veh	0	0	0	0	0	0	0	0	0	0	0	0
Ped-Bike Adj(A_pbT)	1.00		0.99	1.00		1.00	1.00		1.00	1.00		1.00
Parking Bus, Adj	1.00	1.00	1.00	1.00	1.00	1.00	1.00	1.00	1.00	1.00	1.00	1.00
Work Zone On Approach		No			No			No			No	
Adj Sat Flow, veh/h/ln	1870	1870	1870	1870	1870	1870	1870	1870	1870	1870	1870	1870
Adj Flow Rate, veh/h	397	469	184	114	594	225	222	974	0	190	1098	565
Peak Hour Factor	0.96	0.96	0.96	0.96	0.96	0.96	0.96	0.96	0.96	0.96	0.96	0.96
Percent Heavy Veh, %	2	2	2	2	2	2	2	2	2	2	2	2
Cap, veh/h	421	1060	466	134	635	240	231	1371		286	1349	602
Arrive On Green	0.12	0.30	0.30	0.08	0.25	0.25	0.11	0.51	0.00	0.10	0.50	0.50
Sat Flow, veh/h	3456	3554	1564	1781	2522	954	1781	3554	1585	1781	3554	1585
Grp Volume(v), veh/h	397	469	184	114	418	401	222	974	0	190	1098	565
Grp Sat Flow(s),veh/h/ln	1728	1777	1564	1781	1777	1699	1781	1777	1585	1781	1777	1585
Q Serve(g_s), s	18.2	17.1	15.0	10.1	36.9	37.0	12.5	33.6	0.0	10.5	41.6	53.7
Cycle Q Clear(g_c), s	18.2	17.1	15.0	10.1	36.9	37.0	12.5	33.6	0.0	10.5	41.6	53.7
Prop In Lane	1.00		1.00	1.00		0.56	1.00		1.00	1.00		1.00
Lane Grp Cap(c), veh/h	421	1060	466	134	447	428	231	1371		286	1349	602
V/C Ratio(X)	0.94	0.44	0.39	0.85	0.93	0.94	0.96	0.71		0.67	0.81	0.94
Avail Cap(c_a), veh/h	421	1060	466	161	472	451	231	1371		297	1349	602
HCM Platoon Ratio	1.00	1.00	1.00	1.00	1.00	1.00	1.33	1.33	1.33	1.33	1.33	1.33
Upstream Filter(I)	1.00	1.00	1.00	1.00	1.00	1.00	1.00	1.00	0.00	0.09	0.09	0.09
Uniform Delay (d), s/veh	69.7	45.4	44.6	73.1	58.6	58.6	35.5	32.1	0.0	30.4	34.9	37.9
Incr Delay (d2), s/veh	29.4	0.1	0.2	25.3	24.8	26.0	47.7	3.1	0.0	0.4	0.5	3.7
Initial Q Delay(d3),s/veh	0.0	0.0	0.0	0.0	0.0	0.0	0.0	0.0	0.0	0.0	0.0	0.0
%ile BackOfQ(50%),veh/ln	9.8	7.7	5.9	5.6	19.7	19.0	8.2	14.2	0.0	4.4	17.0	20.1
Unsig. Movement Delay, s/veh												
LnGrp Delay(d),s/veh	99.1	45.5	44.8	98.4	83.3	84.6	83.3	35.3	0.0	30.8	35.4	41.6
LnGrp LOS	F	D	D	F	F	F	F	D		C	D	D
Approach Vol, veh/h		1050			933			1196			1853	
Approach Delay, s/veh		65.6			85.7			44.2			36.8	
Approach LOS		E			F			D			D	
Timer - Assigned Phs	1	2	3	4	5	6	7	8				
Phs Duration (G+Y+Rc), s	19.0	68.2	18.6	54.2	20.0	67.2	26.0	46.8				
Change Period (Y+Rc), s	6.5	6.5	6.5	6.5	6.5	6.5	6.5	6.5				
Max Green Setting (Gmax), s	13.5	58.5	14.5	47.5	13.5	58.5	19.5	42.5				
Max Q Clear Time (g_c+I1), s	12.5	35.6	12.1	19.1	14.5	55.7	20.2	39.0				
Green Ext Time (p_c), s	0.0	7.5	0.0	2.5	0.0	2.2	0.0	1.3				
Intersection Summary												
HCM 6th Ctrl Delay			53.6									
HCM 6th LOS			D									
Notes												
Unsignalized Delay for [NBR] is excluded from calculations of the approach delay and intersection delay.												

Timings

111: NW 66 Avenue & Atlantic Boulevard

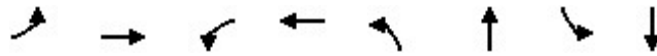

Lane Group	EBL	EBT	WBL	WBT	NBL	NBT	SBL	SBT
Lane Configurations	↶	↷↷↷	↶	↷↷↷	↶	↷	↶	↷
Traffic Volume (vph)	133	1277	62	2028	67	16	136	29
Future Volume (vph)	133	1277	62	2028	67	16	136	29
Turn Type	pm+pt	NA	pm+pt	NA	Perm	NA	Perm	NA
Protected Phases	1	6	5	2		4		8
Permitted Phases	6		2		4		8	
Detector Phase	1	6	5	2	4	4	8	8
Switch Phase								
Minimum Initial (s)	4.0	10.0	4.0	10.0	6.0	6.0	6.0	6.0
Minimum Split (s)	12.0	50.0	12.0	50.0	45.0	45.0	45.0	45.0
Total Split (s)	25.0	87.0	25.0	87.0	48.0	48.0	48.0	48.0
Total Split (%)	15.6%	54.4%	15.6%	54.4%	30.0%	30.0%	30.0%	30.0%
Yellow Time (s)	4.0	4.0	4.0	4.0	4.0	4.0	4.0	4.0
All-Red Time (s)	2.0	2.0	2.0	2.0	2.0	2.0	2.0	2.0
Lost Time Adjust (s)	0.0	0.0	0.0	0.0	0.0	0.0	0.0	0.0
Total Lost Time (s)	6.0	6.0	6.0	6.0	6.0	6.0	6.0	6.0
Lead/Lag	Lead	Lag	Lead	Lag				
Lead-Lag Optimize?	Yes	Yes	Yes	Yes				
Recall Mode	None	C-Max	None	C-Max	None	None	None	None
Act Effct Green (s)	125.2	114.9	113.4	108.0	21.7	21.7	21.7	21.7
Actuated g/C Ratio	0.78	0.72	0.71	0.68	0.14	0.14	0.14	0.14
v/c Ratio	0.72	0.38	0.23	0.67	0.70	0.24	0.79	0.50
Control Delay	54.8	9.7	7.5	18.2	98.5	23.5	95.2	18.8
Queue Delay	0.0	0.0	0.0	0.0	0.0	0.0	0.0	0.0
Total Delay	54.8	9.7	7.5	18.2	98.5	23.5	95.2	18.8
LOS	D	A	A	B	F	C	F	B
Approach Delay		13.8		17.9		63.0		53.6
Approach LOS		B		B		E		D

Intersection Summary

Cycle Length: 160

Actuated Cycle Length: 160

Offset: 85 (53%), Referenced to phase 2:WBTL and 6:EBTL, Start of Yellow

Natural Cycle: 110

Control Type: Actuated-Coordinated

Maximum v/c Ratio: 0.79

Intersection Signal Delay: 20.4

Intersection LOS: C

Intersection Capacity Utilization 88.3%

ICU Level of Service E

Analysis Period (min) 15

Splits and Phases: 111: NW 66 Avenue & Atlantic Boulevard

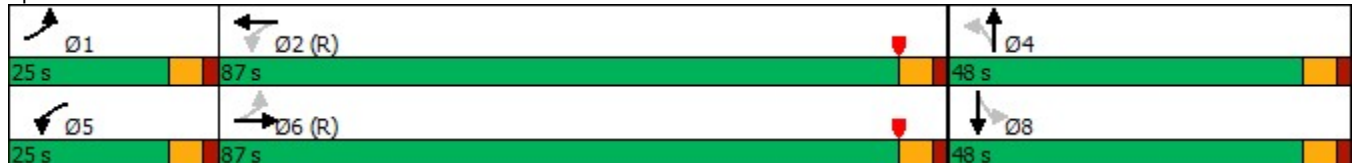

Queues

111: NW 66 Avenue & Atlantic Boulevard

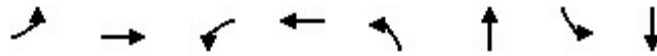

Lane Group	EBL	EBT	WBL	WBT	NBL	NBT	SBL	SBT
Lane Group Flow (vph)	139	1391	65	2276	70	63	142	170
v/c Ratio	0.72	0.38	0.23	0.67	0.70	0.24	0.79	0.50
Control Delay	54.8	9.7	7.5	18.2	98.5	23.5	95.2	18.8
Queue Delay	0.0	0.0	0.0	0.0	0.0	0.0	0.0	0.0
Total Delay	54.8	9.7	7.5	18.2	98.5	23.5	95.2	18.8
Queue Length 50th (ft)	80	189	13	483	71	16	146	28
Queue Length 95th (ft)	159	270	31	701	125	60	217	99
Internal Link Dist (ft)		2560		1156		610		2153
Turn Bay Length (ft)	200		200		190		190	
Base Capacity (vph)	263	3629	424	3398	194	462	347	531
Starvation Cap Reductn	0	0	0	0	0	0	0	0
Spillback Cap Reductn	0	0	0	0	0	0	0	0
Storage Cap Reductn	0	0	0	0	0	0	0	0
Reduced v/c Ratio	0.53	0.38	0.15	0.67	0.36	0.14	0.41	0.32

Intersection Summary

HCM 6th Signalized Intersection Summary

111: NW 66 Avenue & Atlantic Boulevard



Movement	EBL	EBT	EBR	WBL	WBT	WBR	NBL	NBT	NBR	SBL	SBT	SBR
Lane Configurations	↗	↑↑↑		↖	↑↑↑		↖	↑		↗	↑	
Traffic Volume (veh/h)	133	1277	59	62	2028	156	67	16	44	136	29	134
Future Volume (veh/h)	133	1277	59	62	2028	156	67	16	44	136	29	134
Initial Q (Qb), veh	0	0	0	0	0	0	0	0	0	0	0	0
Ped-Bike Adj(A_pbT)	1.00		1.00	1.00		1.00	0.99		0.99	0.99		0.99
Parking Bus, Adj	1.00	1.00	1.00	1.00	1.00	1.00	1.00	1.00	1.00	1.00	1.00	1.00
Work Zone On Approach		No			No			No			No	
Adj Sat Flow, veh/h/ln	1870	1870	1870	1870	1870	1870	1870	1870	1870	1870	1870	1870
Adj Flow Rate, veh/h	139	1330	61	65	2112	162	70	17	46	142	30	140
Peak Hour Factor	0.96	0.96	0.96	0.96	0.96	0.96	0.96	0.96	0.96	0.96	0.96	0.96
Percent Heavy Veh, %	2	2	2	2	2	2	2	2	2	2	2	2
Cap, veh/h	180	3444	158	311	3265	248	143	78	210	237	50	233
Arrive On Green	0.04	0.69	0.69	0.02	0.67	0.67	0.23	0.23	0.23	0.23	0.23	0.23
Sat Flow, veh/h	1781	5004	229	1781	4840	368	1207	442	1196	1326	285	1328
Grp Volume(v), veh/h	139	905	486	65	1481	793	70	0	63	142	0	170
Grp Sat Flow(s),veh/h/ln	1781	1702	1829	1781	1702	1804	1207	0	1638	1326	0	1612
Q Serve(g_s), s	3.9	18.1	18.1	1.8	40.1	40.9	9.0	0.0	5.0	16.1	0.0	15.0
Cycle Q Clear(g_c), s	3.9	18.1	18.1	1.8	40.1	40.9	24.0	0.0	5.0	21.1	0.0	15.0
Prop In Lane	1.00		0.13	1.00		0.20	1.00		0.73	1.00		0.82
Lane Grp Cap(c), veh/h	180	2343	1259	311	2296	1217	143	0	288	237	0	283
V/C Ratio(X)	0.77	0.39	0.39	0.21	0.64	0.65	0.49	0.00	0.22	0.60	0.00	0.60
Avail Cap(c_a), veh/h	325	2343	1259	480	2296	1217	248	0	430	352	0	423
HCM Platoon Ratio	1.00	1.00	1.00	1.00	1.00	1.00	1.33	1.33	1.33	1.33	1.33	1.33
Upstream Filter(I)	1.00	1.00	1.00	1.00	1.00	1.00	1.00	0.00	1.00	1.00	0.00	1.00
Uniform Delay (d), s/veh	27.0	10.6	10.6	8.5	15.0	15.1	67.0	0.0	52.5	61.0	0.0	56.3
Incr Delay (d2), s/veh	2.6	0.5	0.9	0.1	1.4	2.7	1.0	0.0	0.1	0.9	0.0	0.8
Initial Q Delay(d3),s/veh	0.0	0.0	0.0	0.0	0.0	0.0	0.0	0.0	0.0	0.0	0.0	0.0
%ile BackOfQ(50%),veh/ln	3.9	6.9	7.6	0.7	15.6	17.3	2.8	0.0	2.1	5.4	0.0	6.0
Unsig. Movement Delay, s/veh												
LnGrp Delay(d),s/veh	29.6	11.1	11.5	8.6	16.4	17.8	68.0	0.0	52.6	61.9	0.0	57.1
LnGrp LOS	C	B	B	A	B	B	E	A	D	E	A	E
Approach Vol, veh/h		1530			2339			133				312
Approach Delay, s/veh		12.9			16.7			60.7				59.3
Approach LOS		B			B			E				E
Timer - Assigned Phs	1	2		4	5	6		8				
Phs Duration (G+Y+Rc), s	12.0	113.9		34.1	9.8	116.1		34.1				
Change Period (Y+Rc), s	6.0	6.0		6.0	6.0	6.0		6.0				
Max Green Setting (Gmax), s	19.0	81.0		42.0	19.0	81.0		42.0				
Max Q Clear Time (g_c+I1), s	5.9	42.9		26.0	3.8	20.1		23.1				
Green Ext Time (p_c), s	0.1	26.2		0.3	0.0	14.4		0.8				

Intersection Summary

HCM 6th Ctrl Delay	19.8
HCM 6th LOS	B

Notes

User approved pedestrian interval to be less than phase max green.

HCM 6th AWSC
 112: NW 66 Avenue & Margate Boulevard

Intersection	
Intersection Delay, s/veh	14
Intersection LOS	B

Movement	EBL	EBT	EBR	WBL	WBT	WBR	NBL	NBT	NBR	SBL	SBT	SBR
Lane Configurations												
Traffic Vol, veh/h	50	202	57	44	401	28	64	80	50	13	77	65
Future Vol, veh/h	50	202	57	44	401	28	64	80	50	13	77	65
Peak Hour Factor	0.96	0.96	0.96	0.96	0.96	0.96	0.96	0.96	0.96	0.96	0.96	0.96
Heavy Vehicles, %	2	2	2	2	2	2	2	2	2	2	2	2
Mvmt Flow	52	210	59	46	418	29	67	83	52	14	80	68
Number of Lanes	1	2	0	0	2	0	0	1	0	0	1	0

Approach	EB	WB	NB	SB
Opposing Approach	WB	EB	SB	NB
Opposing Lanes	2	3	1	1
Conflicting Approach Left	SB	NB	EB	WB
Conflicting Lanes Left	1	1	3	2
Conflicting Approach Right	NB	SB	WB	EB
Conflicting Lanes Right	1	1	2	3
HCM Control Delay	11.4	15.7	14.7	13.1
HCM LOS	B	C	B	B

Lane	NBLn1	EBLn1	EBLn2	EBLn3	WBLn1	WBLn2	SBLn1
Vol Left, %	33%	100%	0%	0%	18%	0%	8%
Vol Thru, %	41%	0%	100%	54%	82%	88%	50%
Vol Right, %	26%	0%	0%	46%	0%	12%	42%
Sign Control	Stop	Stop	Stop	Stop	Stop	Stop	Stop
Traffic Vol by Lane	194	50	135	124	245	229	155
LT Vol	64	50	0	0	44	0	13
Through Vol	80	0	135	67	201	201	77
RT Vol	50	0	0	57	0	28	65
Lane Flow Rate	202	52	140	130	255	238	161
Geometry Grp	7	7	7	7	8	8	7
Degree of Util (X)	0.403	0.105	0.263	0.231	0.494	0.45	0.317
Departure Headway (Hd)	7.178	7.266	6.754	6.426	6.986	6.806	7.057
Convergence, Y/N	Yes	Yes	Yes	Yes	Yes	Yes	Yes
Cap	501	494	532	560	517	531	510
Service Time	4.913	5.002	4.49	4.162	4.721	4.541	4.794
HCM Lane V/C Ratio	0.403	0.105	0.263	0.232	0.493	0.448	0.316
HCM Control Delay	14.7	10.9	11.9	11.1	16.4	15	13.1
HCM Lane LOS	B	B	B	B	C	B	B
HCM 95th-tile Q	1.9	0.3	1	0.9	2.7	2.3	1.4

Timings

101: Rock Island Road & Royal Palm Boulevard



Lane Group	EBL	EBT	WBL	WBT	NBL	NBT	NBR	SBL	SBT	SBR
Lane Configurations										
Traffic Volume (vph)	137	562	286	970	363	642	258	200	756	180
Future Volume (vph)	137	562	286	970	363	642	258	200	756	180
Turn Type	Prot	NA	Prot	NA	pm+pt	NA	Perm	pm+pt	NA	Perm
Protected Phases	1	6	5	2	7	4		3	8	
Permitted Phases					4		4	8		8
Detector Phase	1	6	5	2	7	4	4	3	8	8
Switch Phase										
Minimum Initial (s)	5.0	10.0	5.0	10.0	4.0	6.0	6.0	4.0	6.0	6.0
Minimum Split (s)	11.5	43.5	11.5	43.5	10.5	43.5	43.5	10.5	39.0	39.0
Total Split (s)	26.0	64.0	26.0	64.0	31.0	45.0	45.0	25.0	39.0	39.0
Total Split (%)	16.3%	40.0%	16.3%	40.0%	19.4%	28.1%	28.1%	15.6%	24.4%	24.4%
Yellow Time (s)	4.5	4.5	4.5	4.5	4.5	4.5	4.5	4.5	4.5	4.5
All-Red Time (s)	2.0	2.0	2.0	2.0	2.0	2.0	2.0	2.0	2.0	2.0
Lost Time Adjust (s)	0.0	0.0	0.0	0.0	0.0	0.0	0.0	0.0	0.0	0.0
Total Lost Time (s)	6.5	6.5	6.5	6.5	6.5	6.5	6.5	6.5	6.5	6.5
Lead/Lag	Lead	Lag	Lead	Lag	Lead	Lag	Lag	Lead	Lag	Lag
Lead-Lag Optimize?	Yes	Yes	Yes	Yes	Yes	Yes	Yes	Yes	Yes	Yes
Recall Mode	None	C-Max	None	C-Max	None	None	None	None	None	None
Act Effct Green (s)	16.0	57.5	19.5	61.0	63.3	40.9	40.9	48.6	32.5	32.5
Actuated g/C Ratio	0.10	0.36	0.12	0.38	0.40	0.26	0.26	0.30	0.20	0.20
v/c Ratio	0.81	0.66	1.39	0.95	1.19	0.74	0.51	0.79	1.10	0.46
Control Delay	101.7	43.7	248.2	62.0	164.0	45.1	12.7	56.2	120.8	26.4
Queue Delay	0.0	0.0	0.0	0.0	0.0	0.0	0.0	0.0	0.0	0.0
Total Delay	101.7	43.7	248.2	62.0	164.0	45.1	12.7	56.2	120.8	26.4
LOS	F	D	F	E	F	D	B	E	F	C
Approach Delay		52.3		97.8		72.6			94.4	
Approach LOS		D		F		E			F	

Intersection Summary

Cycle Length: 160

Actuated Cycle Length: 160

Offset: 104 (65%), Referenced to phase 2:WBT and 6:EBT, Start of Yellow

Natural Cycle: 140

Control Type: Actuated-Coordinated

Maximum v/c Ratio: 1.39

Intersection Signal Delay: 81.7

Intersection LOS: F

Intersection Capacity Utilization 104.5%

ICU Level of Service G

Analysis Period (min) 15

Splits and Phases: 101: Rock Island Road & Royal Palm Boulevard

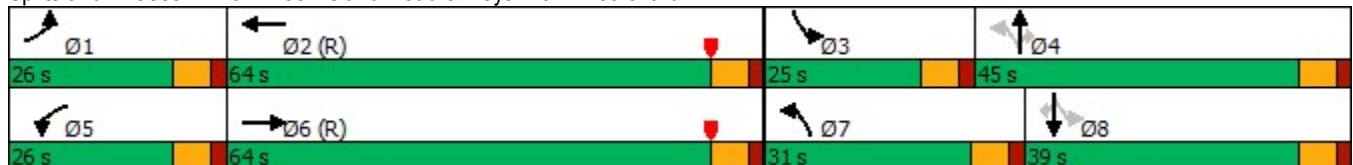

Queues

101: Rock Island Road & Royal Palm Boulevard



Lane Group	EBL	EBT	WBL	WBT	NBL	NBT	NBR	SBL	SBT	SBR
Lane Group Flow (vph)	143	819	298	1251	378	669	269	208	788	188
v/c Ratio	0.81	0.66	1.39	0.95	1.19	0.74	0.51	0.79	1.10	0.46
Control Delay	101.7	43.7	248.2	62.0	164.0	45.1	12.7	56.2	120.8	26.4
Queue Delay	0.0	0.0	0.0	0.0	0.0	0.0	0.0	0.0	0.0	0.0
Total Delay	101.7	43.7	248.2	62.0	164.0	45.1	12.7	56.2	120.8	26.4
Queue Length 50th (ft)	148	360	~412	662	~413	326	47	148	~488	68
Queue Length 95th (ft)	225	435	#612	#850	#639	373	87	217	#623	151
Internal Link Dist (ft)		625		856		3088			735	
Turn Bay Length (ft)	300		200		200		160	140		170
Base Capacity (vph)	215	1244	215	1321	317	904	529	289	718	410
Starvation Cap Reductn	0	0	0	0	0	0	0	0	0	0
Spillback Cap Reductn	0	0	0	0	0	0	0	0	0	0
Storage Cap Reductn	0	0	0	0	0	0	0	0	0	0
Reduced v/c Ratio	0.67	0.66	1.39	0.95	1.19	0.74	0.51	0.72	1.10	0.46

Intersection Summary

~ Volume exceeds capacity, queue is theoretically infinite.

Queue shown is maximum after two cycles.

95th percentile volume exceeds capacity, queue may be longer.

Queue shown is maximum after two cycles.

HCM 6th Signalized Intersection Summary

101: Rock Island Road & Royal Palm Boulevard

Movement	EBL	EBT	EBR	WBL	WBT	WBR	NBL	NBT	NBR	SBL	SBT	SBR
Lane Configurations												
Traffic Volume (veh/h)	137	562	225	286	970	231	363	642	258	200	756	180
Future Volume (veh/h)	137	562	225	286	970	231	363	642	258	200	756	180
Initial Q (Qb), veh	0	0	0	0	0	0	0	0	0	0	0	0
Ped-Bike Adj(A_pbT)	1.00		1.00	1.00		1.00	1.00		1.00	1.00		1.00
Parking Bus, Adj	1.00	1.00	1.00	1.00	1.00	1.00	1.00	1.00	1.00	1.00	1.00	1.00
Work Zone On Approach		No			No			No			No	
Adj Sat Flow, veh/h/ln	1870	1870	1870	1870	1870	1870	1870	1870	1870	1870	1870	1870
Adj Flow Rate, veh/h	143	585	234	298	1010	241	378	669	269	208	788	188
Peak Hour Factor	0.96	0.96	0.96	0.96	0.96	0.96	0.96	0.96	0.96	0.96	0.96	0.96
Percent Heavy Veh, %	2	2	2	2	2	2	2	2	2	2	2	2
Cap, veh/h	163	891	356	217	1110	264	318	895	399	274	722	322
Arrive On Green	0.12	0.48	0.48	0.16	0.52	0.52	0.10	0.17	0.17	0.10	0.20	0.20
Sat Flow, veh/h	1781	2479	990	1781	2848	677	1781	3554	1585	1781	3554	1585
Grp Volume(v), veh/h	143	419	400	298	629	622	378	669	269	208	788	188
Grp Sat Flow(s),veh/h/ln	1781	1777	1692	1781	1777	1748	1781	1777	1585	1781	1777	1585
Q Serve(g_s), s	12.6	28.7	28.8	19.5	51.5	52.1	24.5	28.6	25.5	14.7	32.5	17.2
Cycle Q Clear(g_c), s	12.6	28.7	28.8	19.5	51.5	52.1	24.5	28.6	25.5	14.7	32.5	17.2
Prop In Lane	1.00		0.59	1.00		0.39	1.00		1.00	1.00		1.00
Lane Grp Cap(c), veh/h	163	639	608	217	692	681	318	895	399	274	722	322
V/C Ratio(X)	0.88	0.66	0.66	1.37	0.91	0.91	1.19	0.75	0.67	0.76	1.09	0.58
Avail Cap(c_a), veh/h	217	639	608	217	692	681	318	895	399	294	722	322
HCM Platoon Ratio	1.33	1.33	1.33	1.33	1.33	1.33	0.67	0.67	0.67	1.00	1.00	1.00
Upstream Filter(I)	1.00	1.00	1.00	1.00	1.00	1.00	0.90	0.90	0.90	1.00	1.00	1.00
Uniform Delay (d), s/veh	69.4	34.2	34.3	67.0	35.9	36.1	55.8	61.6	60.3	45.5	63.8	57.6
Incr Delay (d2), s/veh	21.1	5.2	5.5	194.1	17.9	18.8	110.1	2.8	3.3	8.8	61.2	1.8
Initial Q Delay(d3),s/veh	0.0	0.0	0.0	0.0	0.0	0.0	0.0	0.0	0.0	0.0	0.0	0.0
%ile BackOfQ(50%),veh/ln	6.6	12.7	12.2	20.4	24.3	24.3	19.7	13.7	11.0	7.2	20.9	7.1
Unsig. Movement Delay, s/veh												
LnGrp Delay(d),s/veh	90.5	39.4	39.8	261.1	53.9	54.8	165.9	64.4	63.6	54.3	125.0	59.5
LnGrp LOS	F	D	D	F	D	D	F	E	E	D	F	E
Approach Vol, veh/h		962			1549			1316			1184	
Approach Delay, s/veh		47.2			94.1			93.4			102.2	
Approach LOS		D			F			F			F	
Timer - Assigned Phs	1	2	3	4	5	6	7	8				
Phs Duration (G+Y+Rc), s	21.2	68.8	23.2	46.8	26.0	64.0	31.0	39.0				
Change Period (Y+Rc), s	6.5	6.5	6.5	6.5	6.5	6.5	6.5	6.5				
Max Green Setting (Gmax), s	19.5	57.5	18.5	38.5	19.5	57.5	24.5	32.5				
Max Q Clear Time (g_c+I1), s	14.6	54.1	16.7	30.6	21.5	30.8	26.5	34.5				
Green Ext Time (p_c), s	0.0	2.4	0.0	2.4	0.0	5.9	0.0	0.0				
Intersection Summary												
HCM 6th Ctrl Delay				86.8								
HCM 6th LOS				F								
Notes												
User approved pedestrian interval to be less than phase max green.												

HCM 6th TWSC
 102: NW 76 Avenue & Margate Boulevard

Intersection						
Int Delay, s/veh	6					
Movement	EBT	EBR	WBL	WBT	NBL	NBR
Lane Configurations	↑↑		↘	↑↑	↘	
Traffic Vol, veh/h	73	107	122	129	185	56
Future Vol, veh/h	73	107	122	129	185	56
Conflicting Peds, #/hr	0	0	0	0	1	2
Sign Control	Free	Free	Free	Free	Stop	Stop
RT Channelized	-	None	-	None	-	None
Storage Length	-	-	100	-	0	-
Veh in Median Storage, #	0	-	-	0	1	-
Grade, %	0	-	-	0	0	-
Peak Hour Factor	87	87	87	87	87	87
Heavy Vehicles, %	2	2	2	2	2	2
Mvmt Flow	84	123	140	148	213	64

Major/Minor	Major1	Major2	Minor1	Minor2	Minor3
Conflicting Flow All	0	0	207	0	501
Stage 1	-	-	-	-	146
Stage 2	-	-	-	-	355
Critical Hdwy	-	-	4.14	-	5
Critical Hdwy Stg 1	-	-	-	-	5
Critical Hdwy Stg 2	-	-	-	-	5
Follow-up Hdwy	-	-	2.22	-	3
Pot Cap-1 Maneuver	-	-	1361	-	732
Stage 1	-	-	-	-	1041
Stage 2	-	-	-	-	847
Platoon blocked, %	-	-	-	-	-
Mov Cap-1 Maneuver	-	-	1361	-	656
Mov Cap-2 Maneuver	-	-	-	-	673
Stage 1	-	-	-	-	1041
Stage 2	-	-	-	-	759

Approach	EB	WB	NB
HCM Control Delay, s	0	3.9	12.8
HCM LOS			B

Minor Lane/Major Mvmt	NBLn1	EBT	EBR	WBL	WBT
Capacity (veh/h)	739	-	-	1361	-
HCM Lane V/C Ratio	0.375	-	-	0.103	-
HCM Control Delay (s)	12.8	-	-	7.9	-
HCM Lane LOS	B	-	-	A	-
HCM 95th %tile Q(veh)	1.7	-	-	0.3	-

Timings

103: Rock Island Road & Margate Boulevard

Lane Group	EBL	EBT	WBL	WBT	NBL	NBT	NBR	SBL	SBT	SBR
Lane Configurations										
Traffic Volume (vph)	66	44	172	155	32	924	171	114	920	101
Future Volume (vph)	66	44	172	155	32	924	171	114	920	101
Turn Type	pm+pt	NA	pm+pt	NA	pm+pt	NA	Perm	pm+pt	NA	Perm
Protected Phases	7	4	3	8	5	2		1	6	
Permitted Phases	4		8		2		2	6		6
Detector Phase	7	4	3	8	5	2	2	1	6	6
Switch Phase										
Minimum Initial (s)	4.0	6.0	4.0	6.0	4.0	12.0	12.0	4.0	12.0	12.0
Minimum Split (s)	10.0	37.0	10.0	37.0	10.5	37.5	37.5	10.5	37.5	37.5
Total Split (s)	18.0	40.0	18.0	40.0	26.0	76.0	76.0	26.0	76.0	76.0
Total Split (%)	11.3%	25.0%	11.3%	25.0%	16.3%	47.5%	47.5%	16.3%	47.5%	47.5%
Yellow Time (s)	4.0	4.0	4.0	4.0	4.5	4.5	4.5	4.5	4.5	4.5
All-Red Time (s)	2.0	2.0	2.0	2.0	2.0	2.0	2.0	2.0	2.0	2.0
Lost Time Adjust (s)	0.0	0.0	0.0	0.0	0.0	0.0	0.0	0.0	0.0	0.0
Total Lost Time (s)	6.0	6.0	6.0	6.0	6.5	6.5	6.5	6.5	6.5	6.5
Lead/Lag	Lead	Lag	Lead	Lag	Lead	Lag	Lag	Lead	Lag	Lag
Lead-Lag Optimize?	Yes	Yes	Yes	Yes	Yes	Yes	Yes	Yes	Yes	Yes
Recall Mode	None	None	None	None	None	C-Max	C-Max	None	C-Max	C-Max
Act Effct Green (s)	21.5	12.2	26.8	14.9	108.4	103.5	103.5	114.3	108.0	108.0
Actuated g/C Ratio	0.13	0.08	0.17	0.09	0.68	0.65	0.65	0.71	0.68	0.68
v/c Ratio	0.48	0.26	0.80	0.77	0.09	0.43	0.17	0.33	0.41	0.10
Control Delay	64.2	47.0	84.0	51.6	6.7	11.5	5.0	6.1	8.3	0.6
Queue Delay	0.0	0.0	0.0	0.0	0.0	0.0	0.0	0.0	0.0	0.0
Total Delay	64.2	47.0	84.0	51.6	6.7	11.5	5.0	6.1	8.3	0.6
LOS	E	D	F	D	A	B	A	A	A	A
Approach Delay		55.6		63.1		10.3			7.4	
Approach LOS		E		E		B			A	

Intersection Summary

Cycle Length: 160

Actuated Cycle Length: 160

Offset: 104 (65%), Referenced to phase 2:NBTL and 6:SBTL, Start of Yellow

Natural Cycle: 95

Control Type: Actuated-Coordinated

Maximum v/c Ratio: 0.80

Intersection Signal Delay: 20.1

Intersection LOS: C

Intersection Capacity Utilization 67.2%

ICU Level of Service C

Analysis Period (min) 15

Splits and Phases: 103: Rock Island Road & Margate Boulevard

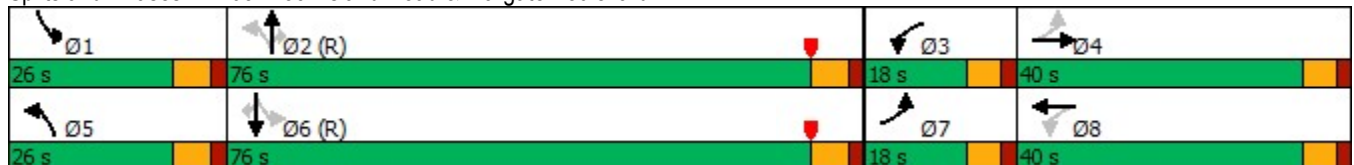

Queues

103: Rock Island Road & Margate Boulevard

























Lane Group	EBL	EBT	WBL	WBT	NBL	NBT	NBR	SBL	SBT	SBR
Lane Group Flow (vph)	71	71	185	336	34	994	184	123	989	109
v/c Ratio	0.48	0.26	0.80	0.77	0.09	0.43	0.17	0.33	0.41	0.10
Control Delay	64.2	47.0	84.0	51.6	6.7	11.5	5.0	6.1	8.3	0.6
Queue Delay	0.0	0.0	0.0	0.0	0.0	0.0	0.0	0.0	0.0	0.0
Total Delay	64.2	47.0	84.0	51.6	6.7	11.5	5.0	6.1	8.3	0.6
Queue Length 50th (ft)	64	24	178	104	8	163	19	21	157	0
Queue Length 95th (ft)	107	50	248	157	m13	m199	m34	m33	m211	m0
Internal Link Dist (ft)		2155		508		3616			3088	
Turn Bay Length (ft)	320		110		180		180	190		160
Base Capacity (vph)	179	732	232	810	507	2288	1064	483	2388	1103
Starvation Cap Reductn	0	0	0	0	0	0	0	0	0	0
Spillback Cap Reductn	0	0	0	0	0	0	0	0	0	0
Storage Cap Reductn	0	0	0	0	0	0	0	0	0	0
Reduced v/c Ratio	0.40	0.10	0.80	0.41	0.07	0.43	0.17	0.25	0.41	0.10

Intersection Summary

m Volume for 95th percentile queue is metered by upstream signal.

HCM 6th Signalized Intersection Summary

103: Rock Island Road & Margate Boulevard

												
Movement	EBL	EBT	EBR	WBL	WBT	WBR	NBL	NBT	NBR	SBL	SBT	SBR
Lane Configurations												
Traffic Volume (veh/h)	66	44	22	172	155	157	32	924	171	114	920	101
Future Volume (veh/h)	66	44	22	172	155	157	32	924	171	114	920	101
Initial Q (Qb), veh	0	0	0	0	0	0	0	0	0	0	0	0
Ped-Bike Adj(A_pbT)	1.00		1.00	1.00		1.00	1.00		1.00	1.00		1.00
Parking Bus, Adj	1.00	1.00	1.00	1.00	1.00	1.00	1.00	1.00	1.00	1.00	1.00	1.00
Work Zone On Approach		No			No			No			No	
Adj Sat Flow, veh/h/ln	1870	1870	1870	1870	1870	1870	1870	1870	1870	1870	1870	1870
Adj Flow Rate, veh/h	71	47	24	185	167	169	34	994	184	123	989	109
Peak Hour Factor	0.93	0.93	0.93	0.93	0.93	0.93	0.93	0.93	0.93	0.93	0.93	0.93
Percent Heavy Veh, %	2	2	2	2	2	2	2	2	2	2	2	2
Cap, veh/h	148	223	106	279	221	197	386	2260	1008	382	2323	1036
Arrive On Green	0.05	0.10	0.10	0.08	0.12	0.12	0.03	0.85	0.83	0.05	0.87	0.87
Sat Flow, veh/h	1781	2337	1110	1781	1777	1585	1781	3554	1585	1781	3554	1585
Grp Volume(v), veh/h	71	35	36	185	167	169	34	994	184	123	989	109
Grp Sat Flow(s),veh/h/ln	1781	1777	1671	1781	1777	1585	1781	1777	1585	1781	1777	1585
Q Serve(g_s), s	5.7	2.9	3.2	12.0	14.5	16.7	1.1	11.0	3.8	3.9	9.2	1.6
Cycle Q Clear(g_c), s	5.7	2.9	3.2	12.0	14.5	16.7	1.1	11.0	3.8	3.9	9.2	1.6
Prop In Lane	1.00		0.66	1.00		1.00	1.00		1.00	1.00		1.00
Lane Grp Cap(c), veh/h	148	170	160	279	221	197	386	2260	1008	382	2323	1036
V/C Ratio(X)	0.48	0.21	0.23	0.66	0.76	0.86	0.09	0.44	0.18	0.32	0.43	0.11
Avail Cap(c_a), veh/h	199	378	355	279	378	337	568	2260	1008	532	2323	1036
HCM Platoon Ratio	1.00	1.00	1.00	1.00	1.00	1.00	1.33	1.33	1.30	1.33	1.33	1.33
Upstream Filter(l)	1.00	1.00	1.00	1.00	1.00	1.00	0.66	0.66	0.66	0.21	0.21	0.21
Uniform Delay (d), s/veh	61.9	66.8	66.9	61.8	67.7	68.7	9.8	5.3	5.4	9.6	4.2	3.7
Incr Delay (d2), s/veh	0.9	0.2	0.3	4.7	2.0	4.3	0.0	0.4	0.3	0.0	0.1	0.0
Initial Q Delay(d3),s/veh	0.0	0.0	0.0	0.0	0.0	0.0	0.0	0.0	0.0	0.0	0.0	0.0
%ile BackOfQ(50%),veh/ln	2.6	1.3	1.4	1.7	6.8	7.1	0.4	3.3	1.3	1.5	2.6	0.5
Unsig. Movement Delay, s/veh												
LnGrp Delay(d),s/veh	62.8	67.0	67.2	66.5	69.7	73.0	9.8	5.8	5.6	9.6	4.3	3.8
LnGrp LOS	E	E	E	E	E	E	A	A	A	A	A	A
Approach Vol, veh/h		142			521			1212			1221	
Approach Delay, s/veh		64.9			69.6			5.8			4.8	
Approach LOS		E			E			A			A	
Timer - Assigned Phs	1	2	3	4	5	6	7	8				
Phs Duration (G+Y+Rc), s	12.5	108.2	18.0	21.3	9.6	111.1	13.4	25.9				
Change Period (Y+Rc), s	6.5	6.5	6.0	6.0	6.5	6.5	6.0	6.0				
Max Green Setting (Gmax), s	19.5	69.5	12.0	34.0	19.5	69.5	12.0	34.0				
Max Q Clear Time (g_c+I1), s	5.9	13.0	14.0	5.2	3.1	11.2	7.7	18.7				
Green Ext Time (p_c), s	0.1	10.4	0.0	0.2	0.0	9.9	0.0	1.2				
Intersection Summary												
HCM 6th Ctrl Delay				18.9								
HCM 6th LOS				B								

Timings

104: SR 7 & Margate Boulevard



Lane Group	EBL	EBR	NBL	NBT	SBL	SBT	Ø3
Lane Configurations	↖↗	↗	↖	↑↑↑	↖	↑↑↑	
Traffic Volume (vph)	215	77	108	1762	13	2218	
Future Volume (vph)	215	77	108	1762	13	2218	
Turn Type	Prot	Perm	Prot	NA	Prot	NA	
Protected Phases	4		5	2	1	6	3
Permitted Phases		4					
Detector Phase	4	4	5	2	1	6	
Switch Phase							
Minimum Initial (s)	7.0	7.0	4.0	12.0	4.0	12.0	5.0
Minimum Split (s)	44.5	44.5	11.5	43.0	10.0	44.5	19.0
Total Split (s)	45.0	45.0	22.0	74.0	22.0	74.0	19.0
Total Split (%)	28.1%	28.1%	13.8%	46.3%	13.8%	46.3%	12%
Yellow Time (s)	4.0	4.0	4.0	4.0	4.0	4.0	4.0
All-Red Time (s)	2.5	2.5	2.0	2.0	2.0	2.0	2.5
Lost Time Adjust (s)	0.0	0.0	0.0	0.0	0.0	0.0	
Total Lost Time (s)	6.5	6.5	6.0	6.0	6.0	6.0	
Lead/Lag	Lag	Lag	Lead	Lag	Lead	Lag	Lead
Lead-Lag Optimize?	Yes	Yes	Yes	Yes	Yes	Yes	Yes
Recall Mode	None	None	None	C-Max	None	C-Max	None
Act Effct Green (s)	14.8	14.8	13.9	127.7	5.3	112.8	
Actuated g/C Ratio	0.09	0.09	0.09	0.80	0.03	0.70	
v/c Ratio	0.70	0.33	0.73	0.45	0.22	0.69	
Control Delay	82.2	8.0	64.4	6.1	83.7	15.8	
Queue Delay	0.0	0.0	0.0	0.0	0.0	0.0	
Total Delay	82.2	8.0	64.4	6.1	83.7	15.8	
LOS	F	A	E	A	F	B	
Approach Delay				9.4		16.2	
Approach LOS				A		B	

Intersection Summary

Cycle Length: 160
 Actuated Cycle Length: 160
 Offset: 0 (0%), Referenced to phase 2:NBT and 6:SBT, Start of Yellow
 Natural Cycle: 150
 Control Type: Actuated-Coordinated
 Maximum v/c Ratio: 0.73
 Intersection Signal Delay: 16.4
 Intersection LOS: B
 Intersection Capacity Utilization 72.6%
 ICU Level of Service C
 Analysis Period (min) 15

Splits and Phases: 104: SR 7 & Margate Boulevard

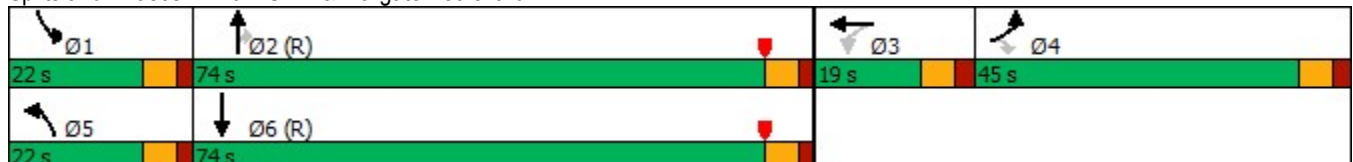

Queues

104: SR 7 & Margate Boulevard



Lane Group	EBL	EBR	NBL	NBT	SBL	SBT
Lane Group Flow (vph)	222	79	111	1816	13	2462
v/c Ratio	0.70	0.33	0.73	0.45	0.22	0.69
Control Delay	82.2	8.0	64.4	6.1	83.7	15.8
Queue Delay	0.0	0.0	0.0	0.0	0.0	0.0
Total Delay	82.2	8.0	64.4	6.1	83.7	15.8
Queue Length 50th (ft)	118	0	122	161	14	504
Queue Length 95th (ft)	160	26	m133	m228	39	678
Internal Link Dist (ft)				2153		276
Turn Bay Length (ft)	120	120	250		200	
Base Capacity (vph)	826	455	185	4058	177	3548
Starvation Cap Reductn	0	0	0	0	0	0
Spillback Cap Reductn	0	0	0	0	0	0
Storage Cap Reductn	0	0	0	0	0	0
Reduced v/c Ratio	0.27	0.17	0.60	0.45	0.07	0.69

Intersection Summary





















m Volume for 95th percentile queue is metered by upstream signal.

HCM 6th Signalized Intersection Summary
104: SR 7 & Margate Boulevard

HCM 6th Edition methodology expects strict NEMA phasing.

HCM Signalized Intersection Capacity Analysis

104: SR 7 & Margate Boulevard

												
Movement	EBL	EBT	EBR	WBL	WBT	WBR	NBL	NBT	NBR	SBL	SBT	SBR
Lane Configurations												
Traffic Volume (vph)	215	0	77	0	0	0	108	1762	0	13	2218	170
Future Volume (vph)	215	0	77	0	0	0	108	1762	0	13	2218	170
Ideal Flow (vphpl)	1900	1900	1900	1900	1900	1900	1900	1900	1900	1900	1900	1900
Total Lost time (s)	6.5		6.5				6.0	6.0		6.0	6.0	
Lane Util. Factor	0.97		1.00				1.00	0.91		1.00	0.91	
Frbp, ped/bikes	1.00		0.99				1.00	1.00		1.00	1.00	
Flpb, ped/bikes	1.00		1.00				1.00	1.00		1.00	1.00	
Frt	1.00		0.85				1.00	1.00		1.00	0.99	
Flt Protected	0.95		1.00				0.95	1.00		0.95	1.00	
Satd. Flow (prot)	3433		1560				1770	5085		1770	5031	
Flt Permitted	0.95		1.00				0.95	1.00		0.95	1.00	
Satd. Flow (perm)	3433		1560				1770	5085		1770	5031	
Peak-hour factor, PHF	0.97	0.97	0.97	0.97	0.97	0.97	0.97	0.97	0.97	0.97	0.97	0.97
Adj. Flow (vph)	222	0	79	0	0	0	111	1816	0	13	2287	175
RTOR Reduction (vph)	0	0	72	0	0	0	0	0	0	0	3	0
Lane Group Flow (vph)	222	0	7	0	0	0	111	1816	0	13	2459	0
Confl. Peds. (#/hr)			2	2								
Turn Type	Prot		Perm				Prot	NA	Perm	Prot	NA	
Protected Phases	4				3		5	2		1	6	
Permitted Phases			4	3					2			
Actuated Green, G (s)	14.8		14.8				13.9	124.1		2.6	112.8	
Effective Green, g (s)	14.8		14.8				13.9	124.1		2.6	112.8	
Actuated g/C Ratio	0.09		0.09				0.09	0.78		0.02	0.70	
Clearance Time (s)	6.5		6.5				6.0	6.0		6.0	6.0	
Vehicle Extension (s)	2.0		2.0				1.5	3.0		1.5	3.0	
Lane Grp Cap (vph)	317		144				153	3944		28	3546	
v/s Ratio Prot	c0.06						c0.06	0.36		0.01	c0.49	
v/s Ratio Perm			0.00									
v/c Ratio	0.70		0.05				0.73	0.46		0.46	0.69	
Uniform Delay, d1	70.4		66.2				71.2	6.3		78.0	13.6	
Progression Factor	1.00		1.00				0.75	1.00		1.00	1.00	
Incremental Delay, d2	5.6		0.1				6.0	0.2		4.4	1.1	
Delay (s)	76.1		66.2				59.1	6.4		82.4	14.8	
Level of Service	E		E				E	A		F	B	
Approach Delay (s)		73.5			0.0			9.5			15.1	
Approach LOS		E			A			A			B	
Intersection Summary												
HCM 2000 Control Delay			16.5				HCM 2000 Level of Service				B	
HCM 2000 Volume to Capacity ratio			0.73									
Actuated Cycle Length (s)			160.0				Sum of lost time (s)			25.0		
Intersection Capacity Utilization			72.6%				ICU Level of Service			C		
Analysis Period (min)			15									
c Critical Lane Group												

Timings

105: Riverside Drive & Atlantic Boulevard /Atlantic Boulevard

Lane Group	EBL	EBT	EBR	WBL	WBT	WBR	NBL	NBT	NBR	SBL	SBT	SBR
Lane Configurations												
Traffic Volume (vph)	162	1009	67	256	952	339	60	700	248	321	517	187
Future Volume (vph)	162	1009	67	256	952	339	60	700	248	321	517	187
Turn Type	Prot	NA	Perm	Prot	NA	Perm	Prot	NA	Perm	Prot	NA	Perm
Protected Phases	1	6		5	2		7	4		3	8	
Permitted Phases			6			2			4			8
Detector Phase	1	6	6	5	2	2	7	4	4	3	8	8
Switch Phase												
Minimum Initial (s)	5.0	12.0	12.0	5.0	12.0	12.0	4.0	6.0	6.0	5.0	6.0	6.0
Minimum Split (s)	11.0	36.0	36.0	24.0	36.0	36.0	10.0	32.0	32.0	11.0	20.0	20.0
Total Split (s)	60.0	50.0	50.0	60.0	50.0	50.0	30.0	32.0	32.0	18.0	20.0	20.0
Total Split (%)	37.5%	31.3%	31.3%	37.5%	31.3%	31.3%	18.8%	20.0%	20.0%	11.3%	12.5%	12.5%
Yellow Time (s)	4.0	5.0	5.0	4.0	5.0	5.0	4.0	5.0	5.0	4.0	5.0	5.0
All-Red Time (s)	2.0	2.0	2.0	2.0	2.0	2.0	2.0	2.0	2.0	2.0	2.0	2.0
Lost Time Adjust (s)	0.0	0.0	0.0	0.0	0.0	0.0	0.0	0.0	0.0	0.0	0.0	0.0
Total Lost Time (s)	6.0	7.0	7.0	6.0	7.0	7.0	6.0	7.0	7.0	6.0	7.0	7.0
Lead/Lag	Lead	Lag	Lag	Lead	Lag	Lag	Lead	Lag	Lag	Lead	Lag	Lag
Lead-Lag Optimize?	Yes	Yes	Yes	Yes	Yes	Yes	Yes	Yes	Yes	Yes	Yes	Yes
Recall Mode	None	C-Max	C-Max	None	C-Max	C-Max	None	None	None	None	None	None
Act Effct Green (s)	11.8	80.6	80.6	16.4	85.2	85.2	6.8	25.0	25.0	12.0	32.3	32.3
Actuated g/C Ratio	0.07	0.50	0.50	0.10	0.53	0.53	0.04	0.16	0.16	0.08	0.20	0.20
v/c Ratio	0.66	0.41	0.08	0.75	0.36	0.35	0.43	1.31	0.58	1.29	0.75	0.41
Control Delay	84.6	25.8	0.2	105.0	13.3	4.2	83.2	201.5	15.2	210.3	67.9	9.7
Queue Delay	0.0	0.0	0.0	0.0	0.0	0.0	0.0	0.0	0.0	0.0	0.0	0.0
Total Delay	84.6	25.8	0.2	105.0	13.3	4.2	83.2	201.5	15.2	210.3	67.9	9.7
LOS	F	C	A	F	B	A	F	F	B	F	E	A
Approach Delay		32.1			26.5			148.6			101.9	
Approach LOS		C			C			F			F	

Intersection Summary





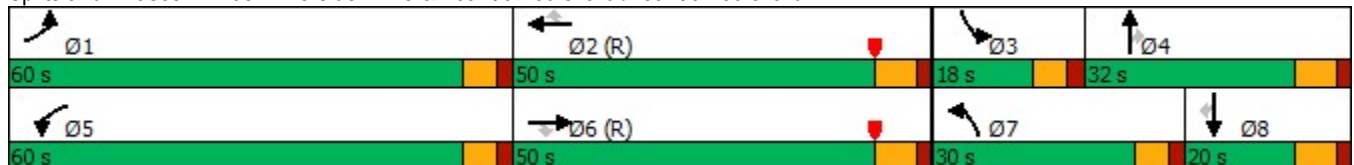







Cycle Length: 160	
Actuated Cycle Length: 160	
Offset: 0 (0%), Referenced to phase 2:WBT and 6:EBT, Start of Yellow	
Natural Cycle: 105	
Control Type: Actuated-Coordinated	
Maximum v/c Ratio: 1.31	
Intersection Signal Delay: 69.5	Intersection LOS: E
Intersection Capacity Utilization 77.7%	ICU Level of Service D
Analysis Period (min) 15	

Splits and Phases: 105: Riverside Drive & Atlantic Boulevard /Atlantic Boulevard



Queues

105: Riverside Drive & Atlantic Boulevard /Atlantic Boulevard

												
Lane Group	EBL	EBT	EBR	WBL	WBT	WBR	NBL	NBT	NBR	SBL	SBT	SBR
Lane Group Flow (vph)	167	1040	69	264	981	349	62	722	256	331	533	193
v/c Ratio	0.66	0.41	0.08	0.75	0.36	0.35	0.43	1.31	0.58	1.29	0.75	0.41
Control Delay	84.6	25.8	0.2	105.0	13.3	4.2	83.2	201.5	15.2	210.3	67.9	9.7
Queue Delay	0.0	0.0	0.0	0.0	0.0	0.0	0.0	0.0	0.0	0.0	0.0	0.0
Total Delay	84.6	25.8	0.2	105.0	13.3	4.2	83.2	201.5	15.2	210.3	67.9	9.7
Queue Length 50th (ft)	89	244	0	150	131	50	33	~508	20	~225	284	0
Queue Length 95th (ft)	128	300	0	200	159	85	59	#641	113	#331	#378	73
Internal Link Dist (ft)		1763			2560			1528			1193	
Turn Bay Length (ft)	250		300	220		270	300		300	300		300
Base Capacity (vph)	1158	2560	861	1158	2708	1006	514	552	440	257	714	469
Starvation Cap Reductn	0	0	0	0	0	0	0	0	0	0	0	0
Spillback Cap Reductn	0	0	0	0	0	0	0	0	0	0	0	0
Storage Cap Reductn	0	0	0	0	0	0	0	0	0	0	0	0
Reduced v/c Ratio	0.14	0.41	0.08	0.23	0.36	0.35	0.12	1.31	0.58	1.29	0.75	0.41

Intersection Summary

~ Volume exceeds capacity, queue is theoretically infinite.

Queue shown is maximum after two cycles.

95th percentile volume exceeds capacity, queue may be longer.

Queue shown is maximum after two cycles.

HCM 6th Signalized Intersection Summary

105: Riverside Drive & Atlantic Boulevard /Atlantic Boulevard

Movement	EBL	EBT	EBR	WBL	WBT	WBR	NBL	NBT	NBR	SBL	SBT	SBR
Lane Configurations												
Traffic Volume (veh/h)	162	1009	67	256	952	339	60	700	248	321	517	187
Future Volume (veh/h)	162	1009	67	256	952	339	60	700	248	321	517	187
Initial Q (Qb), veh	0	0	0	0	0	0	0	0	0	0	0	0
Ped-Bike Adj(A_pbT)	1.00		0.99	1.00		1.00	1.00		0.99	1.00		0.98
Parking Bus, Adj	1.00	1.00	1.00	1.00	1.00	1.00	1.00	1.00	1.00	1.00	1.00	1.00
Work Zone On Approach		No			No			No			No	
Adj Sat Flow, veh/h/ln	1870	1870	1870	1870	1870	1870	1870	1870	1870	1870	1870	1870
Adj Flow Rate, veh/h	167	1040	69	264	981	349	62	722	256	331	533	193
Peak Hour Factor	0.97	0.97	0.97	0.97	0.97	0.97	0.97	0.97	0.97	0.97	0.97	0.97
Percent Heavy Veh, %	2	2	2	2	2	2	2	2	2	2	2	2
Cap, veh/h	211	2639	809	309	2783	864	99	555	246	259	720	316
Arrive On Green	0.08	0.69	0.69	0.12	0.72	0.72	0.03	0.16	0.16	0.08	0.20	0.20
Sat Flow, veh/h	3456	5106	1565	3456	5106	1585	3456	3554	1576	3456	3554	1557
Grp Volume(v), veh/h	167	1040	69	264	981	349	62	722	256	331	533	193
Grp Sat Flow(s),veh/h/ln	1728	1702	1565	1728	1702	1585	1728	1777	1576	1728	1777	1557
Q Serve(g_s), s	7.6	14.0	2.3	12.0	11.4	13.7	2.8	25.0	25.0	12.0	22.5	18.0
Cycle Q Clear(g_c), s	7.6	14.0	2.3	12.0	11.4	13.7	2.8	25.0	25.0	12.0	22.5	18.0
Prop In Lane	1.00		1.00	1.00		1.00	1.00		1.00	1.00		1.00
Lane Grp Cap(c), veh/h	211	2639	809	309	2783	864	99	555	246	259	720	316
V/C Ratio(X)	0.79	0.39	0.09	0.85	0.35	0.40	0.63	1.30	1.04	1.28	0.74	0.61
Avail Cap(c_a), veh/h	1166	2639	809	1166	2783	864	518	555	246	259	720	316
HCM Platoon Ratio	1.33	1.33	1.33	1.33	1.33	1.33	1.00	1.00	1.00	1.00	1.00	1.00
Upstream Filter(l)	1.00	1.00	1.00	0.83	0.83	0.83	1.00	1.00	1.00	1.00	1.00	1.00
Uniform Delay (d), s/veh	72.5	14.3	12.5	69.5	11.6	11.9	76.9	67.5	67.5	74.0	59.8	58.1
Incr Delay (d2), s/veh	2.5	0.4	0.2	2.2	0.3	1.2	2.4	147.9	68.1	151.1	3.6	2.5
Initial Q Delay(d3),s/veh	0.0	0.0	0.0	0.0	0.0	0.0	0.0	0.0	0.0	0.0	0.0	0.0
%ile BackOfQ(50%),veh/ln	3.4	4.9	0.9	5.3	4.0	4.5	1.3	22.8	14.8	10.8	10.6	7.4
Unsig. Movement Delay, s/veh												
LnGrp Delay(d),s/veh	75.0	14.7	12.7	71.7	11.9	13.1	79.3	215.4	135.6	225.1	63.4	60.6
LnGrp LOS	E	B	B	E	B	B	E	F	F	F	E	E
Approach Vol, veh/h		1276			1594			1040			1057	
Approach Delay, s/veh		22.5			22.0			187.7			113.5	
Approach LOS		C			C			F			F	
Timer - Assigned Phs	1	2	3	4	5	6	7	8				
Phs Duration (G+Y+Rc), s	15.8	94.2	18.0	32.0	20.3	89.7	10.6	39.4				
Change Period (Y+Rc), s	6.0	7.0	6.0	7.0	6.0	7.0	6.0	7.0				
Max Green Setting (Gmax), s	54.0	43.0	12.0	25.0	54.0	43.0	24.0	13.0				
Max Q Clear Time (g_c+I1), s	9.6	15.7	14.0	27.0	14.0	16.0	4.8	24.5				
Green Ext Time (p_c), s	0.2	9.6	0.0	0.0	0.3	8.8	0.0	0.0				
Intersection Summary												
HCM 6th Ctrl Delay				76.3								
HCM 6th LOS				E								
Notes												
User approved pedestrian interval to be less than phase max green.												

Timings

106: Ramblewood Drive & Atlantic Boulevard



Lane Group	EBL	EBT	WBL	WBT	NBL	NBT	NBR	SBL	SBT	SBR
Lane Configurations	↖	↗↖↗	↖	↗↖↗	↖	↗↖	↗	↖	↗	↗
Traffic Volume (vph)	51	1480	99	1732	22	9	24	118	17	57
Future Volume (vph)	51	1480	99	1732	22	9	24	118	17	57
Turn Type	pm+pt	NA	pm+pt	NA	Perm	NA	Perm	Perm	NA	Perm
Protected Phases	1	6	5	2		4			8	
Permitted Phases	6		2		4		4	8		8
Detector Phase	1	6	5	2	4	4	4	8	8	8
Switch Phase										
Minimum Initial (s)	4.0	12.0	4.0	12.0	6.0	6.0	6.0	6.0	6.0	6.0
Minimum Split (s)	11.0	45.0	11.0	45.0	36.0	36.0	36.0	36.0	36.0	36.0
Total Split (s)	25.0	85.0	25.0	85.0	50.0	50.0	50.0	50.0	50.0	50.0
Total Split (%)	15.6%	53.1%	15.6%	53.1%	31.3%	31.3%	31.3%	31.3%	31.3%	31.3%
Yellow Time (s)	5.0	5.0	5.0	5.0	4.0	4.0	4.0	4.0	4.0	4.0
All-Red Time (s)	2.0	2.0	2.0	2.0	2.0	2.0	2.0	2.0	2.0	2.0
Lost Time Adjust (s)	0.0	0.0	0.0	0.0	0.0	0.0	0.0	0.0	0.0	0.0
Total Lost Time (s)	7.0	7.0	7.0	7.0	6.0	6.0	6.0	6.0	6.0	6.0
Lead/Lag	Lead	Lag	Lead	Lag						
Lead-Lag Optimize?	Yes	Yes	Yes	Yes						
Recall Mode	None	C-Max	None	C-Max	None	None	None	None	None	None
Act Effct Green (s)	119.4	113.7	122.2	116.6	19.9	19.9	19.9	19.9	19.9	19.9
Actuated g/C Ratio	0.75	0.71	0.76	0.73	0.12	0.12	0.12	0.12	0.12	0.12
v/c Ratio	0.33	0.45	0.45	0.55	0.13	0.02	0.10	0.73	0.08	0.24
Control Delay	12.4	2.5	12.9	2.3	61.1	57.8	0.8	90.1	59.4	9.2
Queue Delay	0.0	0.0	0.0	0.0	0.0	0.0	0.0	0.0	0.0	0.0
Total Delay	12.4	2.5	12.9	2.3	61.1	57.8	0.8	90.1	59.4	9.2
LOS	B	A	B	A	E	E	A	F	E	A
Approach Delay		2.8		2.8		34.0			63.3	
Approach LOS		A		A		C			E	

Intersection Summary

Cycle Length: 160
 Actuated Cycle Length: 160
 Offset: 80 (50%), Referenced to phase 2:WBTL and 6:EBTL, Start of Yellow
 Natural Cycle: 95
 Control Type: Actuated-Coordinated
 Maximum v/c Ratio: 0.73
 Intersection Signal Delay: 6.3
 Intersection Capacity Utilization 71.0%
 Analysis Period (min) 15
 Intersection LOS: A
 ICU Level of Service C

Splits and Phases: 106: Ramblewood Drive & Atlantic Boulevard

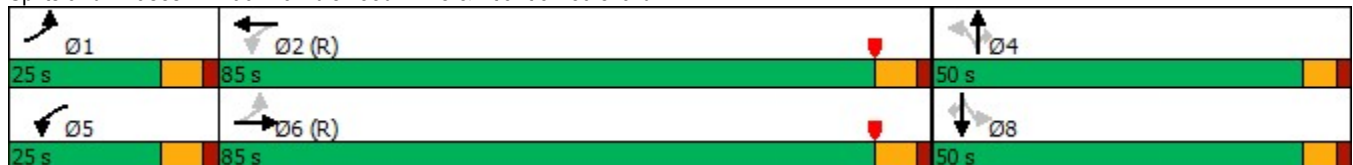

Queues

106: Ramblewood Drive & Atlantic Boulevard





























Lane Group	EBL	EBT	WBL	WBT	NBL	NBT	NBR	SBL	SBT	SBR
Lane Group Flow (vph)	54	1614	105	2013	23	10	26	126	18	61
v/c Ratio	0.33	0.45	0.45	0.55	0.13	0.02	0.10	0.73	0.08	0.24
Control Delay	12.4	2.5	12.9	2.3	61.1	57.8	0.8	90.1	59.4	9.2
Queue Delay	0.0	0.0	0.0	0.0	0.0	0.0	0.0	0.0	0.0	0.0
Total Delay	12.4	2.5	12.9	2.3	61.1	57.8	0.8	90.1	59.4	9.2
Queue Length 50th (ft)	4	37	4	30	22	4	0	129	17	0
Queue Length 95th (ft)	m15	m63	46	50	49	14	0	196	41	31
Internal Link Dist (ft)		2560		3088		436			532	
Turn Bay Length (ft)	180		180		200		425	180		275
Base Capacity (vph)	294	3599	353	3657	380	973	483	384	512	483
Starvation Cap Reductn	0	0	0	0	0	0	0	0	0	0
Spillback Cap Reductn	0	0	0	0	0	0	0	0	0	0
Storage Cap Reductn	0	0	0	0	0	0	0	0	0	0
Reduced v/c Ratio	0.18	0.45	0.30	0.55	0.06	0.01	0.05	0.33	0.04	0.13

Intersection Summary

m Volume for 95th percentile queue is metered by upstream signal.

HCM 6th Signalized Intersection Summary

106: Ramblewood Drive & Atlantic Boulevard

												
Movement	EBL	EBT	EBR	WBL	WBT	WBR	NBL	NBT	NBR	SBL	SBT	SBR
Lane Configurations		 			 			 		 		 
Traffic Volume (veh/h)	51	1480	38	99	1732	160	22	9	24	118	17	57
Future Volume (veh/h)	51	1480	38	99	1732	160	22	9	24	118	17	57
Initial Q (Qb), veh	0	0	0	0	0	0	0	0	0	0	0	0
Ped-Bike Adj(A_pbT)	1.00		1.00	1.00		0.99	1.00		0.99	1.00		0.99
Parking Bus, Adj	1.00	1.00	1.00	1.00	1.00	1.00	1.00	1.00	1.00	1.00	1.00	1.00
Work Zone On Approach		No			No			No			No	
Adj Sat Flow, veh/h/ln	1870	1870	1870	1870	1870	1870	1870	1870	1870	1870	1870	1870
Adj Flow Rate, veh/h	54	1574	40	105	1843	170	23	10	26	126	18	61
Peak Hour Factor	0.94	0.94	0.94	0.94	0.94	0.94	0.94	0.94	0.94	0.94	0.94	0.94
Percent Heavy Veh, %	2	2	2	2	2	2	2	2	2	2	2	2
Cap, veh/h	238	3744	95	319	3500	321	186	412	183	200	217	183
Arrive On Green	0.03	0.97	0.97	0.04	0.98	0.98	0.12	0.12	0.12	0.12	0.12	0.12
Sat Flow, veh/h	1781	5121	130	1781	4753	436	1314	3554	1577	1365	1870	1577
Grp Volume(v), veh/h	54	1046	568	105	1318	695	23	10	26	126	18	61
Grp Sat Flow(s),veh/h/ln	1781	1702	1847	1781	1702	1785	1314	1777	1577	1365	1870	1577
Q Serve(g_s), s	1.2	2.3	2.3	2.4	2.6	2.7	2.5	0.4	2.4	14.4	1.4	5.7
Cycle Q Clear(g_c), s	1.2	2.3	2.3	2.4	2.6	2.7	3.9	0.4	2.4	14.8	1.4	5.7
Prop In Lane	1.00		0.07	1.00		0.24	1.00		1.00	1.00		1.00
Lane Grp Cap(c), veh/h	238	2489	1350	319	2507	1314	186	412	183	200	217	183
V/C Ratio(X)	0.23	0.42	0.42	0.33	0.53	0.53	0.12	0.02	0.14	0.63	0.08	0.33
Avail Cap(c_a), veh/h	398	2489	1350	470	2507	1314	395	977	434	417	514	434
HCM Platoon Ratio	1.33	1.33	1.33	1.33	1.33	1.33	1.00	1.00	1.00	1.00	1.00	1.00
Upstream Filter(I)	0.75	0.75	0.75	0.79	0.79	0.79	1.00	1.00	1.00	1.00	1.00	1.00
Uniform Delay (d), s/veh	5.0	0.6	0.6	4.9	0.5	0.5	64.9	62.7	63.6	69.3	63.1	65.0
Incr Delay (d2), s/veh	0.1	0.4	0.7	0.2	0.6	1.2	0.3	0.0	0.4	3.3	0.2	1.1
Initial Q Delay(d3),s/veh	0.0	0.0	0.0	0.0	0.0	0.0	0.0	0.0	0.0	0.0	0.0	0.0
%ile BackOfQ(50%),veh/ln	0.5	0.6	0.8	0.9	0.7	0.9	0.9	0.2	1.0	5.2	0.7	0.1
Unsig. Movement Delay, s/veh												
LnGrp Delay(d),s/veh	5.1	1.0	1.3	5.1	1.1	1.7	65.2	62.7	63.9	72.5	63.3	66.1
LnGrp LOS	A	A	A	A	A	A	E	E	E	E	E	E
Approach Vol, veh/h		1668			2118			59			205	
Approach Delay, s/veh		1.3			1.5			64.2			69.8	
Approach LOS		A			A			E			E	
Timer - Assigned Phs	1	2		4	5	6		8				
Phs Duration (G+Y+Rc), s	10.6	124.8		24.5	11.5	124.0		24.5				
Change Period (Y+Rc), s	7.0	7.0		6.0	7.0	7.0		6.0				
Max Green Setting (Gmax), s	18.0	78.0		44.0	18.0	78.0		44.0				
Max Q Clear Time (g_c+I1), s	3.2	4.7		5.9	4.4	4.3		16.8				
Green Ext Time (p_c), s	0.0	30.2		0.2	0.1	19.2		0.6				
Intersection Summary												
HCM 6th Ctrl Delay				5.8								
HCM 6th LOS				A								

Timings

107: NW 76 Avenue & Atlantic Boulevard



Lane Group	EBL	EBT	WBL	WBT	NBL	NBT	SBL	SBT	SBR
Lane Configurations	↖	↕↕↕	↖	↕↕↕	↖	↗	↖	↕	↗
Traffic Volume (vph)	134	1522	7	1884	33	10	81	7	153
Future Volume (vph)	134	1522	7	1884	33	10	81	7	153
Turn Type	Prot	NA	Prot	NA	Perm	NA	Perm	NA	Perm
Protected Phases	1	6	5	2		4		8	
Permitted Phases					4		8		8
Detector Phase	1	6	5	2	4	4	8	8	8
Switch Phase									
Minimum Initial (s)	4.0	12.0	4.0	12.0	6.0	6.0	6.0	6.0	6.0
Minimum Split (s)	24.0	28.0	10.0	28.0	43.0	43.0	43.0	43.0	43.0
Total Split (s)	25.0	98.0	16.0	89.0	46.0	46.0	46.0	46.0	46.0
Total Split (%)	15.6%	61.3%	10.0%	55.6%	28.8%	28.8%	28.8%	28.8%	28.8%
Yellow Time (s)	4.0	4.0	4.0	4.0	4.0	4.0	4.0	4.0	4.0
All-Red Time (s)	2.0	2.0	2.0	2.0	2.0	2.0	2.0	2.0	2.0
Lost Time Adjust (s)	0.0	0.0	0.0	0.0	0.0	0.0	0.0	0.0	0.0
Total Lost Time (s)	6.0	6.0	6.0	6.0	6.0	6.0	6.0	6.0	6.0
Lead/Lag	Lead	Lag	Lead	Lag					
Lead-Lag Optimize?	Yes	Yes	Yes	Yes					
Recall Mode	None	C-Max	None	C-Max	None	None	None	None	None
Act Effct Green (s)	16.2	131.5	4.8	111.7	14.1	14.1	14.1	14.1	14.1
Actuated g/C Ratio	0.10	0.82	0.03	0.70	0.09	0.09	0.09	0.09	0.09
v/c Ratio	0.77	0.38	0.13	0.59	0.28	0.14	0.69	0.04	0.56
Control Delay	113.2	1.5	63.9	9.4	71.6	39.3	97.0	63.7	17.7
Queue Delay	0.0	0.0	0.0	0.0	0.0	0.0	0.0	0.0	0.0
Total Delay	113.2	1.5	63.9	9.4	71.6	39.3	97.0	63.7	17.7
LOS	F	A	E	A	E	D	F	E	B
Approach Delay		10.4		9.6		58.6		45.7	
Approach LOS		B		A		E		D	

Intersection Summary

Cycle Length: 160
 Actuated Cycle Length: 160
 Offset: 5 (3%), Referenced to phase 2:WBT and 6:EBT, Start of Yellow
 Natural Cycle: 115
 Control Type: Actuated-Coordinated
 Maximum v/c Ratio: 0.77
 Intersection Signal Delay: 12.8
 Intersection Capacity Utilization 73.2%
 Analysis Period (min) 15
 Intersection LOS: B
 ICU Level of Service D

Splits and Phases: 107: NW 76 Avenue & Atlantic Boulevard

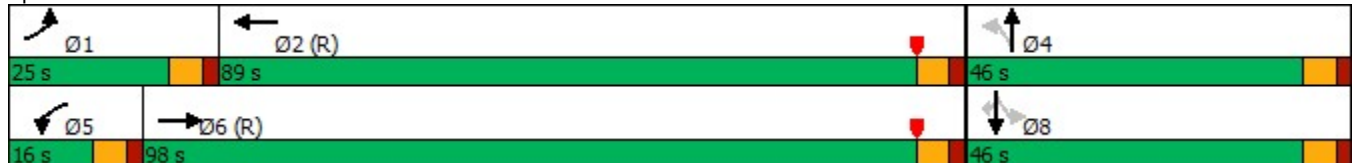

Queues

107: NW 76 Avenue & Atlantic Boulevard



Lane Group	EBL	EBT	WBL	WBT	NBL	NBT	SBL	SBT	SBR
Lane Group Flow (vph)	137	1593	7	2063	34	23	83	7	156
v/c Ratio	0.77	0.38	0.13	0.59	0.28	0.14	0.69	0.04	0.56
Control Delay	113.2	1.5	63.9	9.4	71.6	39.3	97.0	63.7	17.7
Queue Delay	0.0	0.0	0.0	0.0	0.0	0.0	0.0	0.0	0.0
Total Delay	113.2	1.5	63.9	9.4	71.6	39.3	97.0	63.7	17.7
Queue Length 50th (ft)	142	28	8	179	34	10	86	7	3
Queue Length 95th (ft)	192	40	m6	m193	69	39	143	23	74
Internal Link Dist (ft)		3088		2032		396		487	
Turn Bay Length (ft)	150		200		225		200		200
Base Capacity (vph)	218	4160	110	3511	350	431	343	465	505
Starvation Cap Reductn	0	0	0	0	0	0	0	0	0
Spillback Cap Reductn	0	0	0	0	0	0	0	0	0
Storage Cap Reductn	0	0	0	0	0	0	0	0	0
Reduced v/c Ratio	0.63	0.38	0.06	0.59	0.10	0.05	0.24	0.02	0.31

Intersection Summary

m Volume for 95th percentile queue is metered by upstream signal.

HCM 6th Signalized Intersection Summary

107: NW 76 Avenue & Atlantic Boulevard

Movement	EBL	EBT	EBR	WBL	WBT	WBR	NBL	NBT	NBR	SBL	SBT	SBR
Lane Configurations												
Traffic Volume (veh/h)	134	1522	39	7	1884	138	33	10	13	81	7	153
Future Volume (veh/h)	134	1522	39	7	1884	138	33	10	13	81	7	153
Initial Q (Qb), veh	0	0	0	0	0	0	0	0	0	0	0	0
Ped-Bike Adj(A_pbT)	1.00		0.98	1.00		1.00	0.99		0.99	0.99		0.98
Parking Bus, Adj	1.00	1.00	1.00	1.00	1.00	1.00	1.00	1.00	1.00	1.00	1.00	1.00
Work Zone On Approach		No			No			No			No	
Adj Sat Flow, veh/h/ln	1870	1870	1870	1870	1870	1870	1870	1870	1870	1870	1870	1870
Adj Flow Rate, veh/h	137	1553	40	7	1922	141	34	10	13	83	7	156
Peak Hour Factor	0.98	0.98	0.98	0.98	0.98	0.98	0.98	0.98	0.98	0.98	0.98	0.98
Percent Heavy Veh, %	2	2	2	2	2	2	2	2	2	2	2	2
Cap, veh/h	157	3831	99	12	3240	237	201	97	126	210	247	204
Arrive On Green	0.12	1.00	1.00	0.01	0.89	0.89	0.13	0.13	0.13	0.13	0.13	0.13
Sat Flow, veh/h	1781	5116	132	1781	4856	355	1214	734	954	1377	1870	1549
Grp Volume(v), veh/h	137	1033	560	7	1345	718	34	0	23	83	7	156
Grp Sat Flow(s),veh/h/ln	1781	1702	1843	1781	1702	1806	1214	0	1688	1377	1870	1549
Q Serve(g_s), s	12.1	0.3	0.3	0.6	15.0	15.2	4.0	0.0	1.9	9.0	0.5	15.6
Cycle Q Clear(g_c), s	12.1	0.3	0.3	0.6	15.0	15.2	4.5	0.0	1.9	11.0	0.5	15.6
Prop In Lane	1.00		0.07	1.00		0.20	1.00		0.57	1.00		1.00
Lane Grp Cap(c), veh/h	157	2549	1380	12	2271	1205	201	0	223	210	247	204
V/C Ratio(X)	0.87	0.41	0.41	0.59	0.59	0.60	0.17	0.00	0.10	0.40	0.03	0.76
Avail Cap(c_a), veh/h	212	2549	1380	111	2271	1205	345	0	422	373	468	387
HCM Platoon Ratio	1.33	1.33	1.33	1.33	1.33	1.33	1.00	1.00	1.00	1.00	1.00	1.00
Upstream Filter(l)	0.88	0.88	0.88	0.09	0.09	0.09	1.00	0.00	1.00	1.00	1.00	1.00
Uniform Delay (d), s/veh	69.7	0.1	0.1	79.1	3.8	3.9	62.5	0.0	61.1	65.9	60.5	67.0
Incr Delay (d2), s/veh	18.1	0.4	0.8	1.5	0.1	0.2	0.1	0.0	0.1	0.4	0.0	2.2
Initial Q Delay(d3),s/veh	0.0	0.0	0.0	0.0	0.0	0.0	0.0	0.0	0.0	0.0	0.0	0.0
%ile BackOfQ(50%),veh/ln	6.2	0.2	0.4	0.3	3.2	3.4	1.3	0.0	0.8	3.2	0.3	6.3
Unsig. Movement Delay, s/veh												
LnGrp Delay(d),s/veh	87.8	0.5	0.9	80.6	3.9	4.1	62.6	0.0	61.2	66.4	60.5	69.3
LnGrp LOS	F	A	A	F	A	A	E	A	E	E	E	E
Approach Vol, veh/h		1730			2070			57			246	
Approach Delay, s/veh		7.5			4.2			62.1			68.0	
Approach LOS		A			A			E			E	
Timer - Assigned Phs	1	2		4	5	6		8				
Phs Duration (G+Y+Rc), s	20.1	112.7		27.1	7.1	125.8		27.1				
Change Period (Y+Rc), s	6.0	6.0		6.0	6.0	6.0		6.0				
Max Green Setting (Gmax), s	19.0	83.0		40.0	10.0	92.0		40.0				
Max Q Clear Time (g_c+I1), s	14.1	17.2		6.5	2.6	2.3		17.6				
Green Ext Time (p_c), s	0.0	30.4		0.1	0.0	19.1		0.4				
Intersection Summary												
HCM 6th Ctrl Delay				10.3								
HCM 6th LOS				B								

Timings

108: Rock Island Road & Atlantic Boulevard/Atlantic Boulevard



Lane Group	EBL	EBT	WBL	WBT	NBL	NBT	NBR	SBL	SBT
Lane Configurations	↖↗	↕↔	↖↗	↕↔	↖↗	↕↔	↖	↖↗	↕↔
Traffic Volume (vph)	229	1032	524	1537	388	784	326	149	822
Future Volume (vph)	229	1032	524	1537	388	784	326	149	822
Turn Type	Prot	NA	Prot	NA	Prot	NA	Perm	Prot	NA
Protected Phases	1	6	5	2	7	4		3	8
Permitted Phases							4		
Detector Phase	1	6	5	2	7	4	4	3	8
Switch Phase									
Minimum Initial (s)	5.0	12.0	5.0	12.0	5.0	6.0	6.0	5.0	6.0
Minimum Split (s)	11.0	49.0	11.0	49.0	11.5	51.5	51.5	11.5	51.5
Total Split (s)	27.0	54.0	27.0	54.0	27.0	56.0	56.0	23.0	52.0
Total Split (%)	16.9%	33.8%	16.9%	33.8%	16.9%	35.0%	35.0%	14.4%	32.5%
Yellow Time (s)	4.0	4.0	4.0	4.0	4.5	4.5	4.5	4.5	4.5
All-Red Time (s)	2.0	2.0	2.0	2.0	2.0	2.0	2.0	2.0	2.0
Lost Time Adjust (s)	0.0	0.0	0.0	0.0	0.0	0.0	0.0	0.0	0.0
Total Lost Time (s)	6.0	6.0	6.0	6.0	6.5	6.5	6.5	6.5	6.5
Lead/Lag	Lead	Lag	Lead	Lag	Lead	Lag	Lag	Lead	Lag
Lead-Lag Optimize?	Yes	Yes	Yes	Yes	Yes	Yes	Yes	Yes	Yes
Recall Mode	None	C-Max	None	C-Max	None	None	None	None	None
Act Effct Green (s)	15.1	48.0	21.0	53.9	20.2	54.8	54.8	11.2	45.8
Actuated g/C Ratio	0.09	0.30	0.13	0.34	0.13	0.34	0.34	0.07	0.29
v/c Ratio	0.75	0.93	1.23	1.05	0.94	0.68	0.56	0.65	1.01
Control Delay	81.7	67.2	158.8	98.8	81.9	38.9	23.9	99.9	74.3
Queue Delay	0.0	0.0	0.0	0.0	0.0	0.0	0.0	0.0	0.0
Total Delay	81.7	67.2	158.8	98.8	81.9	38.9	23.9	99.9	74.3
LOS	F	E	F	F	F	D	C	F	E
Approach Delay		69.3		113.0		46.7			77.8
Approach LOS		E		F		D			E

Intersection Summary

Cycle Length: 160
 Actuated Cycle Length: 160
 Offset: 109 (68%), Referenced to phase 2:WBT and 6:EBT, Start of Yellow
 Natural Cycle: 145
 Control Type: Actuated-Coordinated
 Maximum v/c Ratio: 1.23
 Intersection Signal Delay: 80.6
 Intersection LOS: F
 Intersection Capacity Utilization 102.1%
 ICU Level of Service G
 Analysis Period (min) 15

Splits and Phases: 108: Rock Island Road & Atlantic Boulevard/Atlantic Boulevard

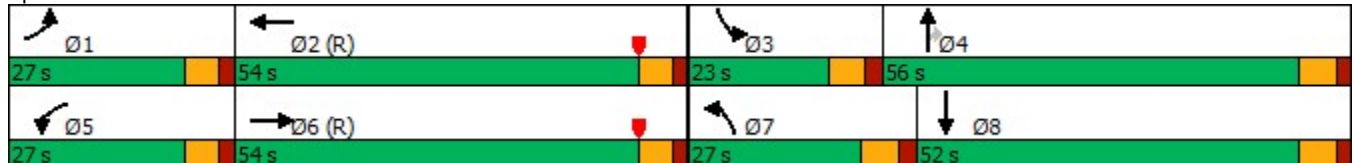

Queues

108: Rock Island Road & Atlantic Boulevard/Atlantic Boulevard



Lane Group	EBL	EBT	WBL	WBT	NBL	NBT	NBR	SBL	SBT
Lane Group Flow (vph)	241	1402	552	1772	408	825	343	157	1011
v/c Ratio	0.75	0.93	1.23	1.05	0.94	0.68	0.56	0.65	1.01
Control Delay	81.7	67.2	158.8	98.8	81.9	38.9	23.9	99.9	74.3
Queue Delay	0.0	0.0	0.0	0.0	0.0	0.0	0.0	0.0	0.0
Total Delay	81.7	67.2	158.8	98.8	81.9	38.9	23.9	99.9	74.3
Queue Length 50th (ft)	136	397	~372	~708	226	403	196	89	~581
Queue Length 95th (ft)	183	#499	m#320	m#612	m#293	m515	m299	m129	#725
Internal Link Dist (ft)		2032		5200		2618			3616
Turn Bay Length (ft)	300		300		210		23	200	
Base Capacity (vph)	450	1506	450	1695	439	1212	611	354	997
Starvation Cap Reductn	0	0	0	0	0	0	0	0	0
Spillback Cap Reductn	0	0	0	0	0	0	0	0	0
Storage Cap Reductn	0	0	0	0	0	0	0	0	0
Reduced v/c Ratio	0.54	0.93	1.23	1.05	0.93	0.68	0.56	0.44	1.01

Intersection Summary

~ Volume exceeds capacity, queue is theoretically infinite.

Queue shown is maximum after two cycles.

































95th percentile volume exceeds capacity, queue may be longer.

Queue shown is maximum after two cycles.

m Volume for 95th percentile queue is metered by upstream signal.

HCM 6th Signalized Intersection Summary

108: Rock Island Road & Atlantic Boulevard/Atlantic Boulevard

												
Movement	EBL	EBT	EBR	WBL	WBT	WBR	NBL	NBT	NBR	SBL	SBT	SBR
Lane Configurations	 	  		 	  		 	 		 	 	
Traffic Volume (veh/h)	229	1032	300	524	1537	146	388	784	326	149	822	139
Future Volume (veh/h)	229	1032	300	524	1537	146	388	784	326	149	822	139
Initial Q (Qb), veh	0	0	0	0	0	0	0	0	0	0	0	0
Ped-Bike Adj(A_pbT)	1.00		1.00	1.00		0.99	1.00		1.00	1.00		1.00
Parking Bus, Adj	1.00	1.00	1.00	1.00	1.00	1.00	1.00	1.00	1.00	1.00	1.00	1.00
Work Zone On Approach		No			No			No			No	
Adj Sat Flow, veh/h/ln	1870	1870	1870	1870	1870	1870	1870	1870	1870	1870	1870	1870
Adj Flow Rate, veh/h	241	1086	316	552	1618	154	408	825	343	157	865	146
Peak Hour Factor	0.95	0.95	0.95	0.95	0.95	0.95	0.95	0.95	0.95	0.95	0.95	0.95
Percent Heavy Veh, %	2	2	2	2	2	2	2	2	2	2	2	2
Cap, veh/h	284	1178	343	454	1653	157	443	1260	561	200	865	146
Arrive On Green	0.11	0.40	0.40	0.17	0.46	0.46	0.04	0.12	0.12	0.06	0.28	0.28
Sat Flow, veh/h	3456	3925	1142	3456	4736	450	3456	3554	1582	3456	3040	513
Grp Volume(v), veh/h	241	942	460	552	1162	610	408	825	343	157	505	506
Grp Sat Flow(s),veh/h/ln	1728	1702	1663	1728	1702	1782	1728	1777	1582	1728	1777	1777
Q Serve(g_s), s	11.0	42.1	42.1	21.0	53.6	53.8	18.8	35.5	33.0	7.2	45.5	45.5
Cycle Q Clear(g_c), s	11.0	42.1	42.1	21.0	53.6	53.8	18.8	35.5	33.0	7.2	45.5	45.5
Prop In Lane	1.00		0.69	1.00		0.25	1.00		1.00	1.00		0.29
Lane Grp Cap(c), veh/h	284	1021	499	454	1188	622	443	1260	561	200	505	505
V/C Ratio(X)	0.85	0.92	0.92	1.22	0.98	0.98	0.92	0.65	0.61	0.78	1.00	1.00
Avail Cap(c_a), veh/h	454	1021	499	454	1188	622	443	1260	561	356	505	505
HCM Platoon Ratio	1.33	1.33	1.33	1.33	1.33	1.33	0.33	0.33	0.33	1.00	1.00	1.00
Upstream Filter(l)	0.92	0.92	0.92	0.09	0.09	0.09	0.52	0.52	0.52	0.88	0.88	0.88
Uniform Delay (d), s/veh	70.3	46.3	46.3	66.0	42.3	42.3	75.8	61.3	60.2	74.4	57.3	57.3
Incr Delay (d2), s/veh	4.2	13.8	23.5	99.6	4.3	7.2	14.9	0.5	0.7	2.3	37.7	37.7
Initial Q Delay(d3),s/veh	0.0	0.0	0.0	0.0	0.0	0.0	0.0	0.0	0.0	0.0	0.0	0.0
%ile BackOfQ(50%),veh/ln	4.9	19.0	19.9	15.3	22.0	23.6	9.8	17.2	14.3	3.3	25.7	25.7
Unsig. Movement Delay, s/veh												
LnGrp Delay(d),s/veh	74.5	60.1	69.9	165.7	46.5	49.5	90.7	61.8	60.9	76.6	94.9	94.9
LnGrp LOS	E	E	E	F	D	D	F	E	E	E	F	F
Approach Vol, veh/h		1643			2324			1576			1168	
Approach Delay, s/veh		64.9			75.6			69.1			92.5	
Approach LOS		E			E			E			F	
Timer - Assigned Phs	1	2	3	4	5	6	7	8				
Phs Duration (G+Y+Rc), s	19.1	61.9	15.8	63.2	27.0	54.0	27.0	52.0				
Change Period (Y+Rc), s	6.0	6.0	6.5	6.5	6.0	6.0	6.5	6.5				
Max Green Setting (Gmax), s	21.0	48.0	16.5	49.5	21.0	48.0	20.5	45.5				
Max Q Clear Time (g_c+I1), s	13.0	55.8	9.2	37.5	23.0	44.1	20.8	47.5				
Green Ext Time (p_c), s	0.2	0.0	0.1	3.8	0.0	2.9	0.0	0.0				
Intersection Summary												
HCM 6th Ctrl Delay			74.4									
HCM 6th LOS			E									

Timings

109: SR 7 & Atlantic Boulevard

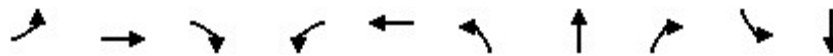

Lane Group	EBL	EBT	EBR	WBL	WBT	NBL	NBT	NBR	SBL	SBT
Lane Configurations	↔↔	↑↑↑	↔	↔↔	↑↑↑	↔	↑↑↑	↔	↔	↑↑↑
Traffic Volume (vph)	353	1027	275	671	1628	232	1318	481	133	1373
Future Volume (vph)	353	1027	275	671	1628	232	1318	481	133	1373
Turn Type	Prot	NA	Perm	Prot	NA	Prot	NA	Perm	Prot	NA
Protected Phases	7	4		3	8	5	2		1	6
Permitted Phases			4					2		
Detector Phase	7	4	4	3	8	5	2	2	1	6
Switch Phase										
Minimum Initial (s)	4.0	6.0	6.0	4.0	6.0	5.0	8.0	8.0	5.0	8.0
Minimum Split (s)	11.0	42.0	42.0	11.0	59.0	12.0	50.0	50.0	12.0	50.0
Total Split (s)	22.0	42.0	42.0	39.0	59.0	24.0	55.0	55.0	24.0	55.0
Total Split (%)	13.8%	26.3%	26.3%	24.4%	36.9%	15.0%	34.4%	34.4%	15.0%	34.4%
Yellow Time (s)	5.0	5.0	5.0	5.0	5.0	5.0	5.0	5.0	5.0	5.0
All-Red Time (s)	2.0	2.0	2.0	2.0	2.0	2.0	2.0	2.0	2.0	2.0
Lost Time Adjust (s)	0.0	0.0	0.0	0.0	0.0	0.0	0.0	0.0	0.0	0.0
Total Lost Time (s)	7.0	7.0	7.0	7.0	7.0	7.0	7.0	7.0	7.0	7.0
Lead/Lag	Lead	Lag	Lag	Lead	Lag	Lead	Lag	Lag	Lead	Lag
Lead-Lag Optimize?	Yes	Yes	Yes	Yes	Yes	Yes	Yes	Yes	Yes	Yes
Recall Mode	None	None	None	None	None	None	C-Max	C-Max	None	C-Max
Act Effct Green (s)	15.0	35.0	35.0	32.0	52.0	17.0	50.0	50.0	15.0	48.0
Actuated g/C Ratio	0.09	0.22	0.22	0.20	0.32	0.11	0.31	0.31	0.09	0.30
v/c Ratio	1.13	0.95	0.56	1.01	1.11	1.27	0.86	0.67	0.83	1.09
Control Delay	143.6	90.6	36.4	98.9	106.5	210.8	58.3	17.3	90.2	110.7
Queue Delay	0.0	0.0	0.0	0.0	0.0	0.0	0.0	0.0	0.0	0.0
Total Delay	143.6	90.6	36.4	98.9	106.5	210.8	58.3	17.3	90.2	110.7
LOS	F	F	D	F	F	F	E	B	F	F
Approach Delay		92.9			104.4		66.0			109.1
Approach LOS		F			F		E			F

Intersection Summary

Cycle Length: 160
 Actuated Cycle Length: 160
 Offset: 114 (71%), Referenced to phase 2:NBT and 6:SBT, Start of Yellow
 Natural Cycle: 145
 Control Type: Actuated-Coordinated
 Maximum v/c Ratio: 1.27
 Intersection Signal Delay: 93.0
 Intersection LOS: F
 Intersection Capacity Utilization 116.5%
 ICU Level of Service H
 Analysis Period (min) 15

Splits and Phases: 109: SR 7 & Atlantic Boulevard

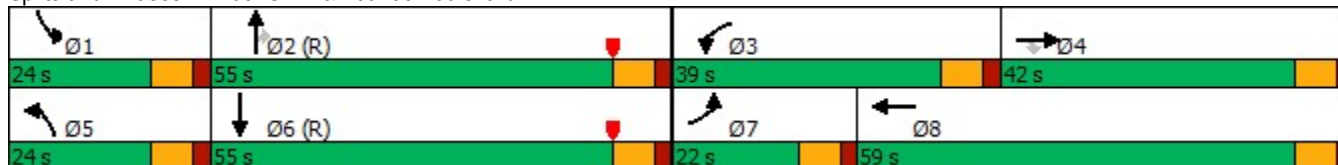

Queues

109: SR 7 & Atlantic Boulevard

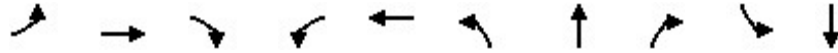

Lane Group	EBL	EBT	EBR	WBL	WBT	NBL	NBT	NBR	SBL	SBT
Lane Group Flow (vph)	364	1059	284	692	1812	239	1359	496	137	1634
v/c Ratio	1.13	0.95	0.56	1.01	1.11	1.27	0.86	0.67	0.83	1.09
Control Delay	143.6	90.6	36.4	98.9	106.5	210.8	58.3	17.3	90.2	110.7
Queue Delay	0.0	0.0	0.0	0.0	0.0	0.0	0.0	0.0	0.0	0.0
Total Delay	143.6	90.6	36.4	98.9	106.5	210.8	58.3	17.3	90.2	110.7
Queue Length 50th (ft)	~232	342	111	~382	~788	~314	498	119	150	~679
Queue Length 95th (ft)	m#293	m#462	m140	#518	#882	#498	564	262	m#229	#778
Internal Link Dist (ft)		5200			1156		610			2153
Turn Bay Length (ft)	275		350	520		400		260	400	
Base Capacity (vph)	321	1112	504	686	1637	188	1588	736	188	1505
Starvation Cap Reductn	0	0	0	0	0	0	0	0	0	0
Spillback Cap Reductn	0	0	0	0	0	0	0	0	0	0
Storage Cap Reductn	0	0	0	0	0	0	0	0	0	0
Reduced v/c Ratio	1.13	0.95	0.56	1.01	1.11	1.27	0.86	0.67	0.73	1.09

Intersection Summary

~ Volume exceeds capacity, queue is theoretically infinite.

Queue shown is maximum after two cycles.

























95th percentile volume exceeds capacity, queue may be longer.

Queue shown is maximum after two cycles.

m Volume for 95th percentile queue is metered by upstream signal.

HCM 6th Signalized Intersection Summary

109: SR 7 & Atlantic Boulevard

												
Movement	EBL	EBT	EBR	WBL	WBT	WBR	NBL	NBT	NBR	SBL	SBT	SBR
Lane Configurations												
Traffic Volume (veh/h)	353	1027	275	671	1628	130	232	1318	481	133	1373	212
Future Volume (veh/h)	353	1027	275	671	1628	130	232	1318	481	133	1373	212
Initial Q (Qb), veh	0	0	0	0	0	0	0	0	0	0	0	0
Ped-Bike Adj(A_pbT)	1.00		0.99	1.00		0.99	1.00		0.99	1.00		0.99
Parking Bus, Adj	1.00	1.00	1.00	1.00	1.00	1.00	1.00	1.00	1.00	1.00	1.00	1.00
Work Zone On Approach		No			No			No			No	
Adj Sat Flow, veh/h/ln	1870	1870	1870	1870	1870	1870	1870	1870	1870	1870	1870	1870
Adj Flow Rate, veh/h	364	1059	284	692	1678	134	239	1359	496	137	1415	219
Peak Hour Factor	0.97	0.97	0.97	0.97	0.97	0.97	0.97	0.97	0.97	0.97	0.97	0.97
Percent Heavy Veh, %	2	2	2	2	2	2	2	2	2	2	2	2
Cap, veh/h	324	1117	344	691	1566	125	189	1624	501	157	1337	207
Arrive On Green	0.09	0.22	0.22	0.20	0.32	0.32	0.14	0.42	0.42	0.12	0.40	0.40
Sat Flow, veh/h	3456	5106	1572	3456	4819	384	1781	5106	1576	1781	4456	689
Grp Volume(v), veh/h	364	1059	284	692	1185	627	239	1359	496	137	1081	553
Grp Sat Flow(s),veh/h/ln	1728	1702	1572	1728	1702	1799	1781	1702	1576	1781	1702	1741
Q Serve(g_s), s	15.0	32.7	27.6	32.0	52.0	52.0	17.0	38.0	50.0	12.1	48.0	48.0
Cycle Q Clear(g_c), s	15.0	32.7	27.6	32.0	52.0	52.0	17.0	38.0	50.0	12.1	48.0	48.0
Prop In Lane	1.00		1.00	1.00		0.21	1.00		1.00	1.00		0.40
Lane Grp Cap(c), veh/h	324	1117	344	691	1106	585	189	1624	501	157	1021	522
V/C Ratio(X)	1.12	0.95	0.83	1.00	1.07	1.07	1.26	0.84	0.99	0.87	1.06	1.06
Avail Cap(c_a), veh/h	324	1117	344	691	1106	585	189	1624	501	189	1021	522
HCM Platoon Ratio	1.00	1.00	1.00	1.00	1.00	1.00	1.33	1.33	1.33	1.33	1.33	1.33
Upstream Filter(I)	0.43	0.43	0.43	1.00	1.00	1.00	1.00	1.00	1.00	0.67	0.67	0.67
Uniform Delay (d), s/veh	72.5	61.6	59.6	64.0	54.0	54.0	68.7	42.4	45.9	69.7	48.1	48.1
Incr Delay (d2), s/veh	72.3	8.5	6.9	34.5	48.1	58.4	153.5	5.3	37.6	19.4	40.2	49.1
Initial Q Delay(d3),s/veh	0.0	0.0	0.0	0.0	0.0	0.0	0.0	0.0	0.0	0.0	0.0	0.0
%ile BackOfQ(50%),veh/ln	9.9	15.0	11.7	17.4	29.6	32.9	15.6	16.1	23.8	6.2	25.1	27.0
Unsig. Movement Delay, s/veh												
LnGrp Delay(d),s/veh	144.8	70.1	66.5	98.5	102.1	112.4	222.2	47.7	83.5	89.1	88.3	97.2
LnGrp LOS	F	E	E	F	F	F	F	D	F	F	F	F
Approach Vol, veh/h		1707			2504			2094			1771	
Approach Delay, s/veh		85.4			103.7			76.1			91.1	
Approach LOS		F			F			E			F	
Timer - Assigned Phs	1	2	3	4	5	6	7	8				
Phs Duration (G+Y+Rc), s	21.1	57.9	39.0	42.0	24.0	55.0	22.0	59.0				
Change Period (Y+Rc), s	7.0	7.0	7.0	7.0	7.0	7.0	7.0	7.0				
Max Green Setting (Gmax), s	17.0	48.0	32.0	35.0	17.0	48.0	15.0	52.0				
Max Q Clear Time (g_c+I1), s	14.1	52.0	34.0	34.7	19.0	50.0	17.0	54.0				
Green Ext Time (p_c), s	0.0	0.0	0.0	0.2	0.0	0.0	0.0	0.0				
Intersection Summary												
HCM 6th Ctrl Delay			89.9									
HCM 6th LOS			F									
Notes												
User approved pedestrian interval to be less than phase max green.												

Timings

110: Southgate Boulevard & Rock Island Road

Lane Group	EBL	EBT	EBR	WBL	WBT	NBL	NBT	NBR	SBL	SBT	SBR	
Lane Configurations												
Traffic Volume (vph)	383	450	177	109	570	213	937	108	182	1056	544	
Future Volume (vph)	383	450	177	109	570	213	937	108	182	1056	544	
Turn Type	Prot	NA	Perm	Prot	NA	pm+pt	NA	Perm	pm+pt	NA	Perm	
Protected Phases	7	4		3	8	5	2		1	6		
Permitted Phases			4			2		2	6		6	
Detector Phase	7	4	4	3	8	5	2	2	1	6	6	
Switch Phase												
Minimum Initial (s)	5.0	6.0	6.0	5.0	6.0	4.0	12.0	12.0	4.0	12.0	12.0	
Minimum Split (s)	11.5	36.5	36.5	11.5	47.5	10.5	44.5	44.5	10.5	44.5	44.5	
Total Split (s)	26.0	54.0	54.0	21.0	49.0	20.0	65.0	65.0	20.0	65.0	65.0	
Total Split (%)	16.3%	33.8%	33.8%	13.1%	30.6%	12.5%	40.6%	40.6%	12.5%	40.6%	40.6%	
Yellow Time (s)	4.5	4.5	4.5	4.5	4.5	4.5	4.5	4.5	4.5	4.5	4.5	
All-Red Time (s)	2.0	2.0	2.0	2.0	2.0	2.0	2.0	2.0	2.0	2.0	2.0	
Lost Time Adjust (s)	0.0	0.0	0.0	0.0	0.0	0.0	0.0	0.0	0.0	0.0	0.0	
Total Lost Time (s)	6.5	6.5	6.5	6.5	6.5	6.5	6.5	6.5	6.5	6.5	6.5	
Lead/Lag	Lead	Lag	Lag	Lead	Lag	Lead	Lag	Lag	Lead	Lag	Lag	
Lead-Lag Optimize?	Yes	Yes	Yes	Yes	Yes	Yes	Yes	Yes	Yes	Yes	Yes	
Recall Mode	None	None	None	None	None	None	C-Max	C-Max	None	C-Max	C-Max	
Act Effct Green (s)	19.5	47.1	47.1	12.9	40.5	76.0	61.4	61.4	71.1	58.5	58.5	
Actuated g/C Ratio	0.12	0.29	0.29	0.08	0.25	0.48	0.38	0.38	0.44	0.37	0.37	
v/c Ratio	0.95	0.45	0.32	0.80	0.93	1.00	0.72	0.17	0.81	0.85	0.76	
Control Delay	102.9	47.5	10.5	108.0	72.7	105.1	46.2	6.1	47.2	50.5	28.1	
Queue Delay	0.0	0.0	0.0	0.0	0.0	0.0	0.0	0.0	0.0	0.0	0.0	
Total Delay	102.9	47.5	10.5	108.0	72.7	105.1	46.2	6.1	47.2	50.5	28.1	
LOS	F	D	B	F	E	F	D	A	D	D	C	
Approach Delay		62.1			77.0		52.8			43.3		
Approach LOS		E			E		D			D		

Intersection Summary

Cycle Length: 160

Actuated Cycle Length: 160

Offset: 80 (50%), Referenced to phase 2:NBTL and 6:SBTL, Start of Yellow

Natural Cycle: 145

Control Type: Actuated-Coordinated

Maximum v/c Ratio: 1.00

Intersection Signal Delay: 55.6

Intersection LOS: E

Intersection Capacity Utilization 96.3%

ICU Level of Service F

Analysis Period (min) 15

Splits and Phases: 110: Southgate Boulevard & Rock Island Road

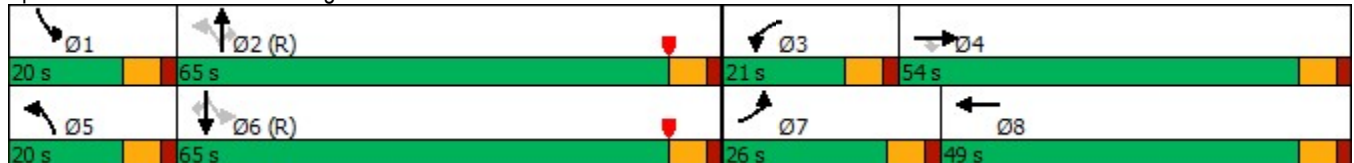

Queues

110: Southgate Boulevard & Rock Island Road



Lane Group	EBL	EBT	EBR	WBL	WBT	NBL	NBT	NBR	SBL	SBT	SBR
Lane Group Flow (vph)	399	469	184	114	821	222	976	113	190	1100	567
v/c Ratio	0.95	0.45	0.32	0.80	0.93	1.00	0.72	0.17	0.81	0.85	0.76
Control Delay	102.9	47.5	10.5	108.0	72.7	105.1	46.2	6.1	47.2	50.5	28.1
Queue Delay	0.0	0.0	0.0	0.0	0.0	0.0	0.0	0.0	0.0	0.0	0.0
Total Delay	102.9	47.5	10.5	108.0	72.7	105.1	46.2	6.1	47.2	50.5	28.1
Queue Length 50th (ft)	217	210	20	118	422	~214	470	1	138	430	227
Queue Length 95th (ft)	#324	266	84	#210	#530	#394	555	44	m132	m395	m196
Internal Link Dist (ft)		387			374		435			2618	
Turn Bay Length (ft)	310		140	220		230			170		170
Base Capacity (vph)	418	1050	574	160	926	221	1358	669	246	1293	750
Starvation Cap Reductn	0	0	0	0	0	0	0	0	0	0	0
Spillback Cap Reductn	0	0	0	0	0	0	0	0	0	0	0
Storage Cap Reductn	0	0	0	0	0	0	0	0	0	0	0
Reduced v/c Ratio	0.95	0.45	0.32	0.71	0.89	1.00	0.72	0.17	0.77	0.85	0.76

Intersection Summary

~ Volume exceeds capacity, queue is theoretically infinite.

Queue shown is maximum after two cycles.























95th percentile volume exceeds capacity, queue may be longer.

Queue shown is maximum after two cycles.

m Volume for 95th percentile queue is metered by upstream signal.

HCM 6th Signalized Intersection Summary

110: Southgate Boulevard & Rock Island Road

												
Movement	EBL	EBT	EBR	WBL	WBT	WBR	NBL	NBT	NBR	SBL	SBT	SBR
Lane Configurations												
Traffic Volume (veh/h)	383	450	177	109	570	218	213	937	108	182	1056	544
Future Volume (veh/h)	383	450	177	109	570	218	213	937	108	182	1056	544
Initial Q (Qb), veh	0	0	0	0	0	0	0	0	0	0	0	0
Ped-Bike Adj(A_pbT)	1.00		0.99	1.00		1.00	1.00		1.00	1.00		1.00
Parking Bus, Adj	1.00	1.00	1.00	1.00	1.00	1.00	1.00	1.00	1.00	1.00	1.00	1.00
Work Zone On Approach		No			No			No			No	
Adj Sat Flow, veh/h/ln	1870	1870	1870	1870	1870	1870	1870	1870	1870	1870	1870	1870
Adj Flow Rate, veh/h	399	469	184	114	594	227	222	976	0	190	1100	567
Peak Hour Factor	0.96	0.96	0.96	0.96	0.96	0.96	0.96	0.96	0.96	0.96	0.96	0.96
Percent Heavy Veh, %	2	2	2	2	2	2	2	2	2	2	2	2
Cap, veh/h	421	1062	467	134	634	242	230	1369		285	1347	601
Arrive On Green	0.12	0.30	0.30	0.08	0.25	0.25	0.11	0.51	0.00	0.10	0.50	0.50
Sat Flow, veh/h	3456	3554	1564	1781	2515	960	1781	3554	1585	1781	3554	1585
Grp Volume(v), veh/h	399	469	184	114	419	402	222	976	0	190	1100	567
Grp Sat Flow(s),veh/h/ln	1728	1777	1564	1781	1777	1698	1781	1777	1585	1781	1777	1585
Q Serve(g_s), s	18.3	17.1	15.0	10.1	37.0	37.1	12.6	33.8	0.0	10.5	41.7	54.1
Cycle Q Clear(g_c), s	18.3	17.1	15.0	10.1	37.0	37.1	12.6	33.8	0.0	10.5	41.7	54.1
Prop In Lane	1.00		1.00	1.00		0.57	1.00		1.00	1.00		1.00
Lane Grp Cap(c), veh/h	421	1062	467	134	448	428	230	1369		285	1347	601
V/C Ratio(X)	0.95	0.44	0.39	0.85	0.94	0.94	0.96	0.71		0.67	0.82	0.94
Avail Cap(c_a), veh/h	421	1062	467	161	472	451	230	1369		296	1347	601
HCM Platoon Ratio	1.00	1.00	1.00	1.00	1.00	1.00	1.33	1.33	1.33	1.33	1.33	1.33
Upstream Filter(I)	1.00	1.00	1.00	1.00	1.00	1.00	1.00	1.00	0.00	0.09	0.09	0.09
Uniform Delay (d), s/veh	69.7	45.3	44.6	73.1	58.6	58.6	35.8	32.2	0.0	30.5	35.0	38.1
Incr Delay (d2), s/veh	30.4	0.1	0.2	25.3	25.0	26.2	48.5	3.2	0.0	0.4	0.5	3.9
Initial Q Delay(d3),s/veh	0.0	0.0	0.0	0.0	0.0	0.0	0.0	0.0	0.0	0.0	0.0	0.0
%ile BackOfQ(50%),veh/ln	9.9	7.7	5.9	5.6	19.8	19.1	8.3	14.3	0.0	4.4	17.1	20.3
Unsig. Movement Delay, s/veh												
LnGrp Delay(d),s/veh	100.2	45.4	44.8	98.4	83.5	84.8	84.4	35.4	0.0	30.9	35.5	42.0
LnGrp LOS	F	D	D	F	F	F	F	D		C	D	D
Approach Vol, veh/h		1052			935			1198			1857	
Approach Delay, s/veh		66.1			85.9			44.5			37.0	
Approach LOS		E			F			D			D	
Timer - Assigned Phs	1	2	3	4	5	6	7	8				
Phs Duration (G+Y+Rc), s	19.0	68.1	18.6	54.3	20.0	67.1	26.0	46.9				
Change Period (Y+Rc), s	6.5	6.5	6.5	6.5	6.5	6.5	6.5	6.5				
Max Green Setting (Gmax), s	13.5	58.5	14.5	47.5	13.5	58.5	19.5	42.5				
Max Q Clear Time (g_c+I1), s	12.5	35.8	12.1	19.1	14.6	56.1	20.3	39.1				
Green Ext Time (p_c), s	0.0	7.5	0.0	2.5	0.0	1.9	0.0	1.3				
Intersection Summary												
HCM 6th Ctrl Delay			53.9									
HCM 6th LOS			D									
Notes												
Unsignalized Delay for [NBR] is excluded from calculations of the approach delay and intersection delay.												

Timings

111: NW 66 Avenue & Atlantic Boulevard

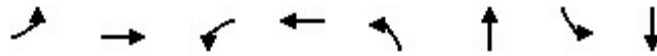

Lane Group	EBL	EBT	WBL	WBT	NBL	NBT	SBL	SBT
Lane Configurations	↙	↑↑↑	↙	↑↑↑	↙	↑	↙	↑
Traffic Volume (vph)	133	1287	62	2046	67	16	136	29
Future Volume (vph)	133	1287	62	2046	67	16	136	29
Turn Type	pm+pt	NA	pm+pt	NA	Perm	NA	Perm	NA
Protected Phases	1	6	5	2		4		8
Permitted Phases	6		2		4		8	
Detector Phase	1	6	5	2	4	4	8	8
Switch Phase								
Minimum Initial (s)	4.0	10.0	4.0	10.0	6.0	6.0	6.0	6.0
Minimum Split (s)	12.0	50.0	12.0	50.0	45.0	45.0	45.0	45.0
Total Split (s)	25.0	87.0	25.0	87.0	48.0	48.0	48.0	48.0
Total Split (%)	15.6%	54.4%	15.6%	54.4%	30.0%	30.0%	30.0%	30.0%
Yellow Time (s)	4.0	4.0	4.0	4.0	4.0	4.0	4.0	4.0
All-Red Time (s)	2.0	2.0	2.0	2.0	2.0	2.0	2.0	2.0
Lost Time Adjust (s)	0.0	0.0	0.0	0.0	0.0	0.0	0.0	0.0
Total Lost Time (s)	6.0	6.0	6.0	6.0	6.0	6.0	6.0	6.0
Lead/Lag	Lead	Lag	Lead	Lag				
Lead-Lag Optimize?	Yes	Yes	Yes	Yes				
Recall Mode	None	C-Max	None	C-Max	None	None	None	None
Act Effct Green (s)	125.2	114.9	113.4	108.0	21.7	21.7	21.7	21.7
Actuated g/C Ratio	0.78	0.72	0.71	0.68	0.14	0.14	0.14	0.14
v/c Ratio	0.74	0.39	0.24	0.68	0.70	0.24	0.79	0.50
Control Delay	57.7	9.7	7.6	18.3	98.5	23.5	95.2	18.8
Queue Delay	0.0	0.0	0.0	0.0	0.0	0.0	0.0	0.0
Total Delay	57.7	9.7	7.6	18.3	98.5	23.5	95.2	18.8
LOS	E	A	A	B	F	C	F	B
Approach Delay		14.1		18.0		63.0		53.6
Approach LOS		B		B		E		D

Intersection Summary

Cycle Length: 160	
Actuated Cycle Length: 160	
Offset: 85 (53%), Referenced to phase 2:WBTL and 6:EBTL, Start of Yellow	
Natural Cycle: 110	
Control Type: Actuated-Coordinated	
Maximum v/c Ratio: 0.79	
Intersection Signal Delay: 20.5	Intersection LOS: C
Intersection Capacity Utilization 88.6%	ICU Level of Service E
Analysis Period (min) 15	

Splits and Phases: 111: NW 66 Avenue & Atlantic Boulevard

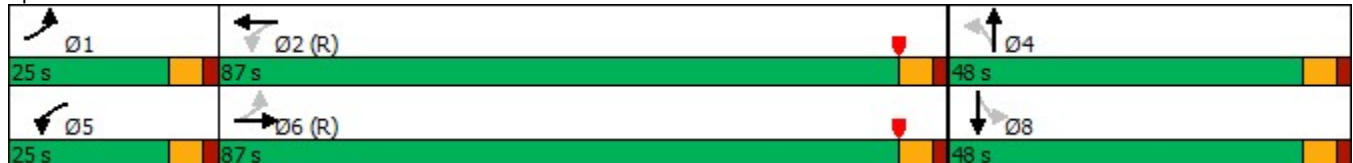

Queues

111: NW 66 Avenue & Atlantic Boulevard

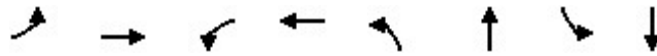

Lane Group	EBL	EBT	WBL	WBT	NBL	NBT	SBL	SBT
Lane Group Flow (vph)	139	1402	65	2294	70	63	142	170
v/c Ratio	0.74	0.39	0.24	0.68	0.70	0.24	0.79	0.50
Control Delay	57.7	9.7	7.6	18.3	98.5	23.5	95.2	18.8
Queue Delay	0.0	0.0	0.0	0.0	0.0	0.0	0.0	0.0
Total Delay	57.7	9.7	7.6	18.3	98.5	23.5	95.2	18.8
Queue Length 50th (ft)	83	190	13	491	71	16	146	28
Queue Length 95th (ft)	162	273	31	712	125	60	217	99
Internal Link Dist (ft)		2560		1156		610		2153
Turn Bay Length (ft)	200		200		190		190	
Base Capacity (vph)	261	3629	421	3398	194	462	347	531
Starvation Cap Reductn	0	0	0	0	0	0	0	0
Spillback Cap Reductn	0	0	0	0	0	0	0	0
Storage Cap Reductn	0	0	0	0	0	0	0	0
Reduced v/c Ratio	0.53	0.39	0.15	0.68	0.36	0.14	0.41	0.32

Intersection Summary

HCM 6th Signalized Intersection Summary

111: NW 66 Avenue & Atlantic Boulevard



Movement	EBL	EBT	EBR	WBL	WBT	WBR	NBL	NBT	NBR	SBL	SBT	SBR
Lane Configurations	↖	↑↑↑		↖	↑↑↑		↖	↑		↖	↑	
Traffic Volume (veh/h)	133	1287	59	62	2046	156	67	16	44	136	29	134
Future Volume (veh/h)	133	1287	59	62	2046	156	67	16	44	136	29	134
Initial Q (Qb), veh	0	0	0	0	0	0	0	0	0	0	0	0
Ped-Bike Adj(A_pbT)	1.00		1.00	1.00		1.00	0.99		0.99	0.99		0.99
Parking Bus, Adj	1.00	1.00	1.00	1.00	1.00	1.00	1.00	1.00	1.00	1.00	1.00	1.00
Work Zone On Approach		No			No			No			No	
Adj Sat Flow, veh/h/ln	1870	1870	1870	1870	1870	1870	1870	1870	1870	1870	1870	1870
Adj Flow Rate, veh/h	139	1341	61	65	2131	162	70	17	46	142	30	140
Peak Hour Factor	0.96	0.96	0.96	0.96	0.96	0.96	0.96	0.96	0.96	0.96	0.96	0.96
Percent Heavy Veh, %	2	2	2	2	2	2	2	2	2	2	2	2
Cap, veh/h	178	3446	157	308	3267	246	143	78	210	237	50	233
Arrive On Green	0.04	0.69	0.69	0.02	0.67	0.67	0.23	0.23	0.23	0.23	0.23	0.23
Sat Flow, veh/h	1781	5006	228	1781	4843	365	1207	442	1196	1326	285	1328
Grp Volume(v), veh/h	139	912	490	65	1493	800	70	0	63	142	0	170
Grp Sat Flow(s),veh/h/ln	1781	1702	1829	1781	1702	1805	1207	0	1638	1326	0	1612
Q Serve(g_s), s	3.9	18.2	18.2	1.8	40.7	41.5	9.0	0.0	5.0	16.1	0.0	15.0
Cycle Q Clear(g_c), s	3.9	18.2	18.2	1.8	40.7	41.5	24.0	0.0	5.0	21.1	0.0	15.0
Prop In Lane	1.00		0.12	1.00		0.20	1.00		0.73	1.00		0.82
Lane Grp Cap(c), veh/h	178	2343	1259	308	2296	1217	143	0	288	237	0	283
V/C Ratio(X)	0.78	0.39	0.39	0.21	0.65	0.66	0.49	0.00	0.22	0.60	0.00	0.60
Avail Cap(c_a), veh/h	323	2343	1259	477	2296	1217	248	0	430	352	0	423
HCM Platoon Ratio	1.00	1.00	1.00	1.00	1.00	1.00	1.33	1.33	1.33	1.33	1.33	1.33
Upstream Filter(I)	1.00	1.00	1.00	1.00	1.00	1.00	1.00	0.00	1.00	1.00	0.00	1.00
Uniform Delay (d), s/veh	27.6	10.6	10.6	8.5	15.1	15.2	67.0	0.0	52.5	61.0	0.0	56.3
Incr Delay (d2), s/veh	2.8	0.5	0.9	0.1	1.4	2.8	1.0	0.0	0.1	0.9	0.0	0.8
Initial Q Delay(d3),s/veh	0.0	0.0	0.0	0.0	0.0	0.0	0.0	0.0	0.0	0.0	0.0	0.0
%ile BackOfQ(50%),veh/ln	3.9	7.0	7.7	0.7	15.8	17.6	2.8	0.0	2.1	5.4	0.0	6.0
Unsig. Movement Delay, s/veh												
LnGrp Delay(d),s/veh	30.4	11.1	11.5	8.7	16.5	18.0	68.0	0.0	52.6	61.9	0.0	57.1
LnGrp LOS	C	B	B	A	B	B	E	A	D	E	A	E
Approach Vol, veh/h		1541			2358			133				312
Approach Delay, s/veh		13.0			16.8			60.7				59.3
Approach LOS		B			B			E				E
Timer - Assigned Phs	1	2		4	5	6		8				
Phs Duration (G+Y+Rc), s	12.0	113.9		34.1	9.8	116.1		34.1				
Change Period (Y+Rc), s	6.0	6.0		6.0	6.0	6.0		6.0				
Max Green Setting (Gmax), s	19.0	81.0		42.0	19.0	81.0		42.0				
Max Q Clear Time (g_c+I1), s	5.9	43.5		26.0	3.8	20.2		23.1				
Green Ext Time (p_c), s	0.1	26.1		0.3	0.0	14.5		0.8				

Intersection Summary

HCM 6th Ctrl Delay	19.8
HCM 6th LOS	B

Notes

User approved pedestrian interval to be less than phase max green.

HCM 6th AWSC
 112: NW 66 Avenue & Margate Boulevard

Intersection	
Intersection Delay, s/veh	14.1
Intersection LOS	B

Movement	EBL	EBT	EBR	WBL	WBT	WBR	NBL	NBT	NBR	SBL	SBT	SBR
Lane Configurations												
Traffic Vol, veh/h	50	206	57	44	408	28	64	80	50	13	77	65
Future Vol, veh/h	50	206	57	44	408	28	64	80	50	13	77	65
Peak Hour Factor	0.96	0.96	0.96	0.96	0.96	0.96	0.96	0.96	0.96	0.96	0.96	0.96
Heavy Vehicles, %	2	2	2	2	2	2	2	2	2	2	2	2
Mvmt Flow	52	215	59	46	425	29	67	83	52	14	80	68
Number of Lanes	1	2	0	0	2	0	0	1	0	0	1	0

Approach	EB	WB	NB	SB
Opposing Approach	WB	EB	SB	NB
Opposing Lanes	2	3	1	1
Conflicting Approach Left	SB	NB	EB	WB
Conflicting Lanes Left	1	1	3	2
Conflicting Approach Right	NB	SB	WB	EB
Conflicting Lanes Right	1	1	2	3
HCM Control Delay	11.5	15.9	14.8	13.1
HCM LOS	B	C	B	B

Lane	NBLn1	EBLn1	EBLn2	EBLn3	WBLn1	WBLn2	SBLn1
Vol Left, %	33%	100%	0%	0%	18%	0%	8%
Vol Thru, %	41%	0%	100%	55%	82%	88%	50%
Vol Right, %	26%	0%	0%	45%	0%	12%	42%
Sign Control	Stop	Stop	Stop	Stop	Stop	Stop	Stop
Traffic Vol by Lane	194	50	137	126	248	232	155
LT Vol	64	50	0	0	44	0	13
Through Vol	80	0	137	69	204	204	77
RT Vol	50	0	0	57	0	28	65
Lane Flow Rate	202	52	143	131	258	242	161
Geometry Grp	7	7	7	7	8	8	7
Degree of Util (X)	0.405	0.105	0.269	0.235	0.503	0.458	0.318
Departure Headway (Hd)	7.211	7.286	6.774	6.45	7.004	6.827	7.092
Convergence, Y/N	Yes	Yes	Yes	Yes	Yes	Yes	Yes
Cap	499	492	531	558	514	529	507
Service Time	4.947	5.023	4.511	4.186	4.739	4.562	4.83
HCM Lane V/C Ratio	0.405	0.106	0.269	0.235	0.502	0.457	0.318
HCM Control Delay	14.8	10.9	12	11.2	16.6	15.2	13.1
HCM Lane LOS	B	B	B	B	C	C	B
HCM 95th-tile Q	1.9	0.3	1.1	0.9	2.8	2.4	1.4

HCM 6th TWSC
 201: Driveway & Margate Blvd

Intersection						
Int Delay, s/veh	1.3					
Movement	EBT	EBR	WBL	WBT	NBL	NBR
Lane Configurations	↑↑		↖	↑↑		↗
Traffic Vol, veh/h	152	0	49	265	0	28
Future Vol, veh/h	152	0	49	265	0	28
Conflicting Peds, #/hr	0	0	0	0	0	0
Sign Control	Free	Free	Free	Free	Stop	Stop
RT Channelized	-	None	-	None	-	None
Storage Length	-	-	75	-	-	0
Veh in Median Storage, #	0	-	-	0	1	-
Grade, %	0	-	-	0	0	-
Peak Hour Factor	92	92	92	92	92	92
Heavy Vehicles, %	2	2	2	2	2	2
Mvmt Flow	165	0	53	288	0	30

Major/Minor	Major1	Major2	Minor1	Minor2	Minor3
Conflicting Flow All	0	0	165	0	-
Stage 1	-	-	-	-	-
Stage 2	-	-	-	-	-
Critical Hdwy	-	-	4.14	-	-
Critical Hdwy Stg 1	-	-	-	-	-
Critical Hdwy Stg 2	-	-	-	-	-
Follow-up Hdwy	-	-	2.22	-	-
Pot Cap-1 Maneuver	-	-	1411	-	0
Stage 1	-	-	-	-	0
Stage 2	-	-	-	-	0
Platoon blocked, %	-	-	-	-	-
Mov Cap-1 Maneuver	-	-	1411	-	-
Mov Cap-2 Maneuver	-	-	-	-	-
Stage 1	-	-	-	-	-
Stage 2	-	-	-	-	-

Approach	EB	WB	NB
HCM Control Delay, s	0	1.2	8.6
HCM LOS			A

Minor Lane/Major Mvmt	NBLn1	EBT	EBR	WBL	WBT
Capacity (veh/h)	1027	-	-	1411	-
HCM Lane V/C Ratio	0.03	-	-	0.038	-
HCM Control Delay (s)	8.6	-	-	7.7	-
HCM Lane LOS	A	-	-	A	-
HCM 95th %tile Q(veh)	0.1	-	-	0.1	-

The School Board of Broward County, Florida
PRELIMINARY SCHOOL CAPACITY AVAILABILITY DETERMINATION (SCAD)

SITE PLAN
SBBC-3446-2022
County No: TBD
Folio #: N/A
Novel of Margate
April 24, 2024



SCAD Expiration Date: October 14, 2024

Growth Management
Facility Planning and Real Estate Department
600 SE 3rd Avenue, 8th Floor
Fort Lauderdale, Florida 33301
Tel: (754) 321-2177 Fax: (754) 321-2179
www.browardschools.com

**PRELIMINARY SCHOOL CAPACITY AVAILABILITY DETERMINATION
SITE PLAN**

PROJECT INFORMATION	NUMBER & TYPE OF PROPOSED UNITS	OTHER PROPOSED USES	ADDITIONAL STUDENT IMPACT
Date: April 24, 2024 10:02:37 Folio # N/A	Single-Family:		Elementary: 12
Name: Nove of Margate	Townhouse: 82		Middle: 5
SBBC Project Number: SBBC-3446-2022	Garden Apartments:		High: 8
County Project Number: TBD	Mid-Rise:		Total: 25
Municipality Project Number: 23-00400014	High-Rise:		
Owner/Developer: Fimiani Development Corporation	Mobile Home:		
Jurisdiction: Margate	Total: 82		

Comments

District staff reviewed and issued a preliminary School Capacity Availability Determination (SCAD) Letter for this site plan application that preliminarily vests the project for public school concurrency for 132 (three-bedroom or more) townhouse units, which were anticipated to generate 39 (19 elementary, 7 middle, and 13 high school) students into Broward County Public Schools.

The school Concurrency Service Areas (CSA) serving the project site in the 2022/23 school year included Atlantic West Elementary, Margate Middle, and Coconut Creek High. The same schools are serving the site in the 2023/24 school year. The project was determined to meet public school concurrency requirements because adequate school capacity was projected to be available to support the project.

This preliminary determination for 132 (three-bedroom or more) townhouse units was due to expire on April 17, 2024. However, the applicant requested an extension of this preliminary SCAD prior to its expiration date. As such, the preliminary determination shall be valid for a one-time extension of an additional 180 days from the original expiration date (April 17, 2024) and shall expire on October 14, 2024. Please be advised that the expiration of the SCAD will require the submission of a new application and fee for a new public school concurrency determination. This preliminary school concurrency determination shall be deemed void unless prior to October 14, 2024, notification of final approval to the District has been provided. Upon the District's receipt of sufficient evidence of final approval, which shall minimally specify the number, type, and bedroom mix for the approved residential units, the District will issue and provide a final SCAD letter for the approved units, which shall ratify and commence the vesting period for the approved residential project.

Please be advised that if a change is proposed to the development, which increases the number of students generated by the project, the additional students will not be considered vested for public school concurrency.

Students generated are based on the student generation rates contained in the currently adopted Broward County Land Development Code.

4/24/2024

Date

Reviewed By:

Glennika D. Gordon

Signature

Glennika D. Gordon, AICP

Name

Planner

Title

Amanda Martinez

From: Robert Hely <rhely@win-waste.com>
Sent: Thursday, October 13, 2022 11:49 AM
To: Amanda Martinez
Subject: Re: Margate Land Use Plan Amendment-Capacity Conformation
Attachments: Solid Waste Letter Request.pdf

Win-waste innovations, formerly Wheelabrator, is the City of Margate's solid waste processor. We have capacity for 830,000 tons of solid waste per year, with a current demand of 775,000 tons per year. We have ample capacity to process the additional solid waste anticipated to be generated by your proposed development project. This proposed development and the solid waste anticipated to be generated will have no adverse impact on our facility or our operations.

Bob Hely, Market Manager

Tel (954) 581-6606 | Cell 954 980-6998
4400 South State Road 7 Fort Lauderdale, Florida 33314
Email : RHely@Win-Waste.com



On Oct 13, 2022, at 11:28 AM, Amanda Martinez <amartinez@dmbblaw.com> wrote:

*** EXTERNAL email. Please be cautious and evaluate before you click on links, open attachments, or provide credentials. ***

Hi Robert,

I have attached a request for a letter confirming the information for the landfill and the capacity to serve a proposed townhome development in the City of Margate. Can you please review the attached request and confirm the information is correct and that there is capacity to serve the project?

Thank you,

Amanda Martinez, Land Planner
Dunay, Miskel and Backman, LLP
14 SE 4th Street, Suite 36
Boca Raton, FL 33432
Tel (direct): (954)304-7755
Tel(main): 561-405-3300
Fax: (561)409-2341
E-mail: amartinez@dmbblaw.com

CONFIDENTIALITY NOTICE: This message originates from WIN Waste Innovations. This message and any attachments are solely for the use of the intended recipient(s) and may contain privileged and/or confidential information or other information protected from disclosure. If you are not the intended recipient, you are hereby notified that you received this email in error and that any review, dissemination, distribution or copying of this

email and any attachment is strictly prohibited. If you have received this email in error, please contact the sender and delete the message and any attachments from your system.[Privacy Policy](#)



751 NW 31st Avenue, Fort Lauderdale, FL 33311
O (954) 583-1830; F (954) 327-9521 republicservices.com

October 19, 2022

DMBB Law
Attn: Amanda Martinez

RE: 7870 Margate Blvd, Margate, FL

To Whom It May Concern,

This is to confirm that Republic Services, as the franchise hauler for the city of Margate, will provide trash and recycle services for Springdale Townhomes, at the referenced address.

We are proud to be the city's service provider and are available to answer any questions or provide further assistance.

Sincerely,
Karen Morrison
Territory Executive
e kmorrison@republicservices.com
o (954) 327-9540 c (954) 205-0720